

1:	9.8	↘
2:	9.7	←
3:	9.4	→
4:	9.6	↘
5:	9.1	↗
6:	9.2	↗
7:	10.0	↗
8:	10.6x	↘
9:	10.0	↗
10:	10.0	→

Serie	<b>94</b>
-------	-----------

Total	<b>0</b>
-------	----------

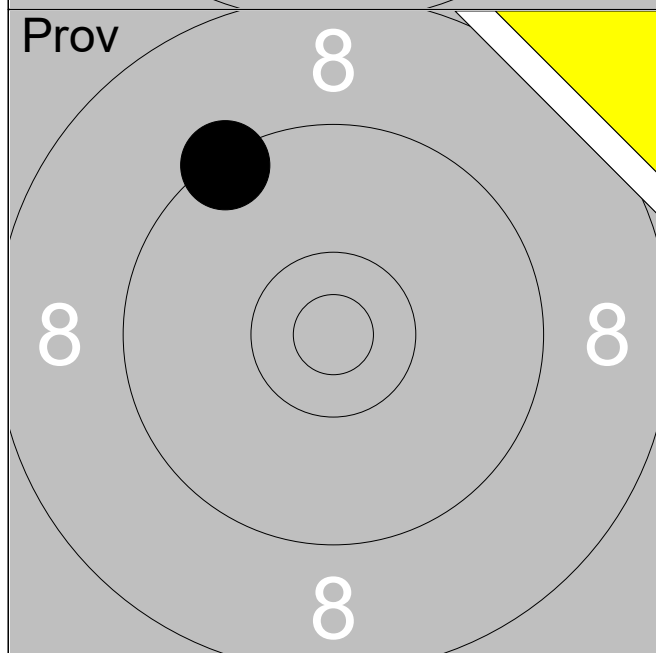

11:	9.4	↗
-----	-----	---

Serie	<b>9</b>
-------	----------

Total	<b>0</b>
-------	----------

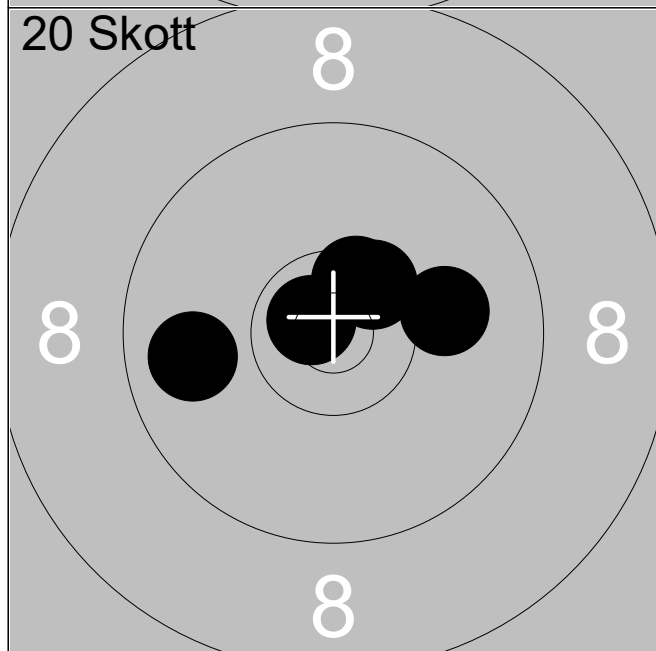

1:	10.8x	↖
2:	10.5x	↗
3:	9.8	←
4:	10.5x	↗
5:	10.1	→

Serie	<b>49</b>
-------	-----------

Total	<b>49</b>
-------	-----------

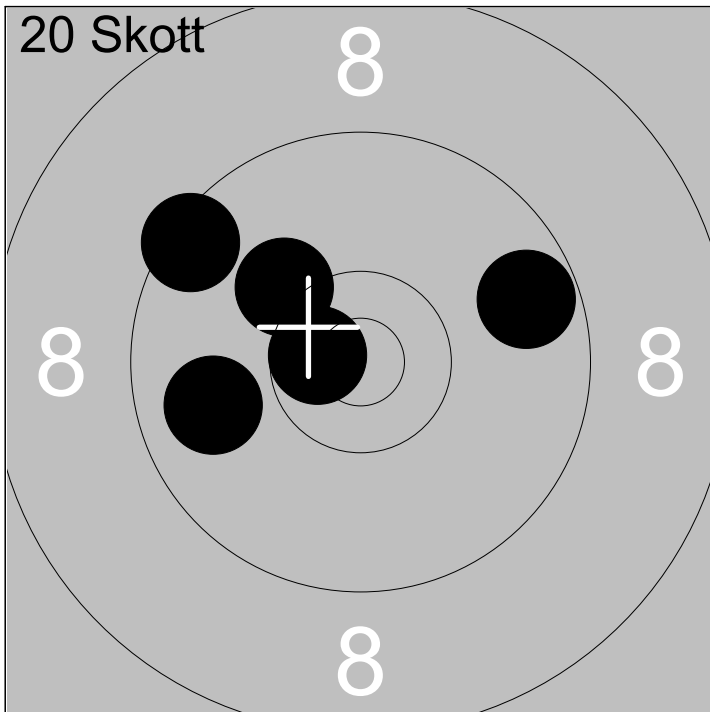

6:	10.6x	←
7:	10.2	↗
8:	9.7	→
9:	9.8	←
10:	9.5	↖

Serie	47
Total	96

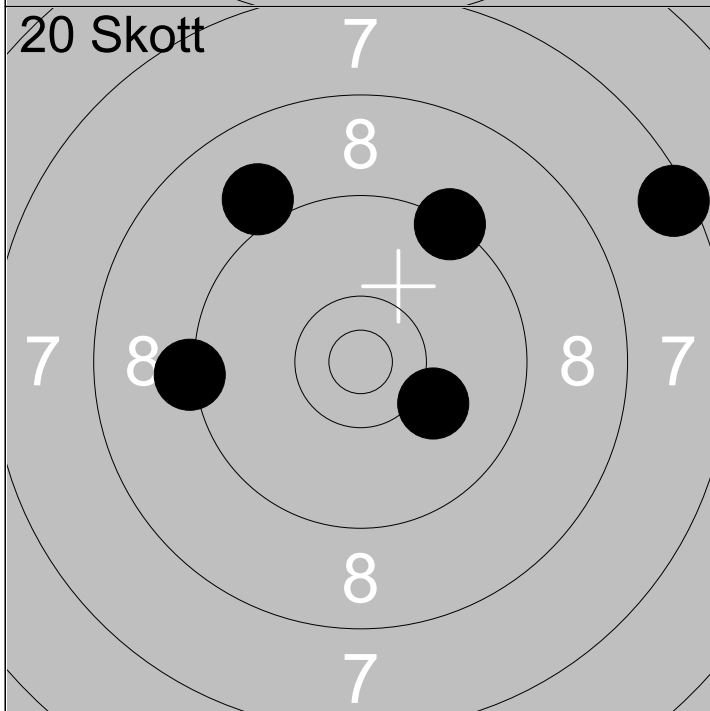

11:	7.5	↗
12:	10.1	↘
13:	9.0	↖
14:	9.3	↗
15:	9.2	←

Serie	44
Total	140

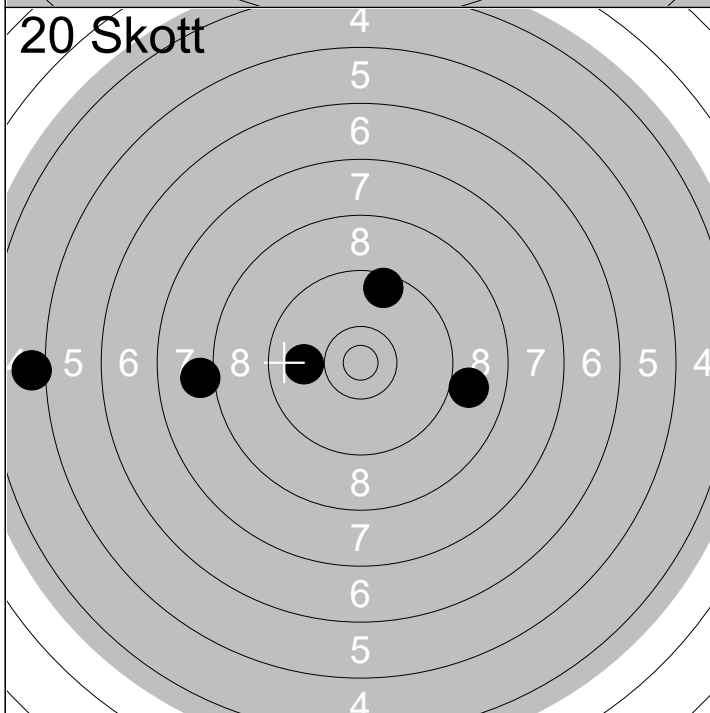

16:	5.0	←
17:	8.1	←
18:	9.0	→
19:	9.6	↗
20:	9.9	←

Serie	40
Total	180

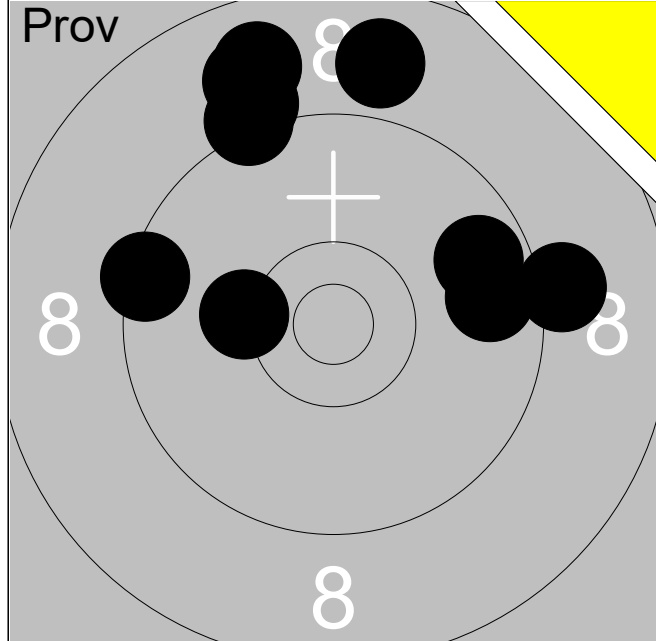

1:	8.9	↑
2:	9.2	↑
3:	8.8	↑
4:	10.2	←
5:	9.1	↑
6:	9.7	→
7:	9.4	←
8:	9.7	→
9:	8.9	↑
10:	9.1	→
<b>Serie</b>		<b>88</b>
<b>Total</b>		<b>0</b>

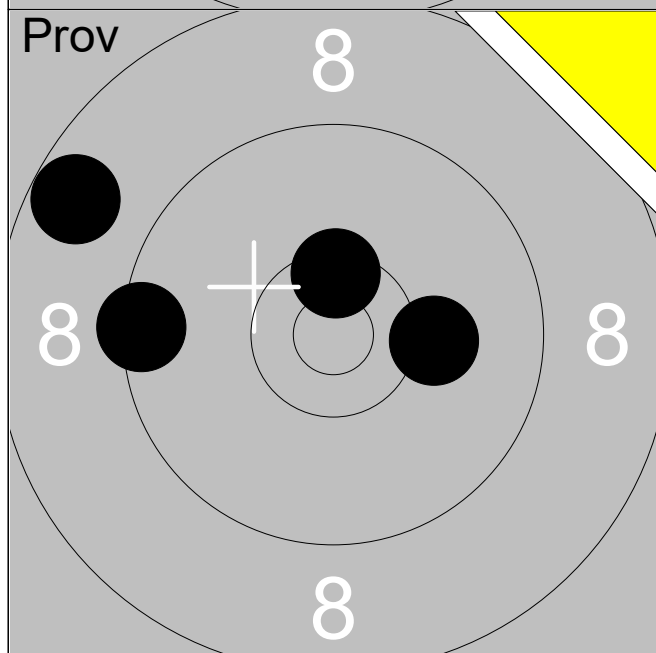

11:	10.5x	↑
12:	8.7	↖
13:	10.2	→
14:	9.4	←
<b>Serie</b>		<b>37</b>
<b>Total</b>		<b>0</b>

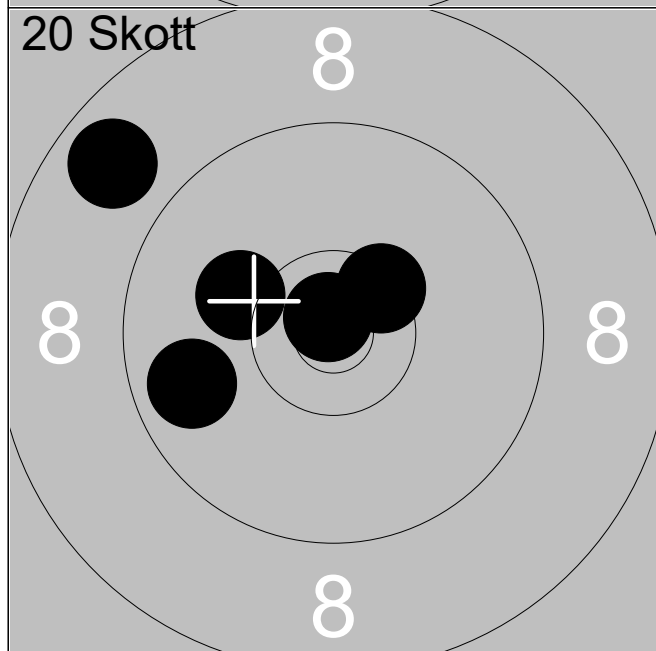

1:	8.8	↖
2:	10.2	↖
3:	10.8x	↑
4:	9.8	←
5:	10.4x	↗
<b>Serie</b>		<b>47</b>
<b>Total</b>		<b>47</b>

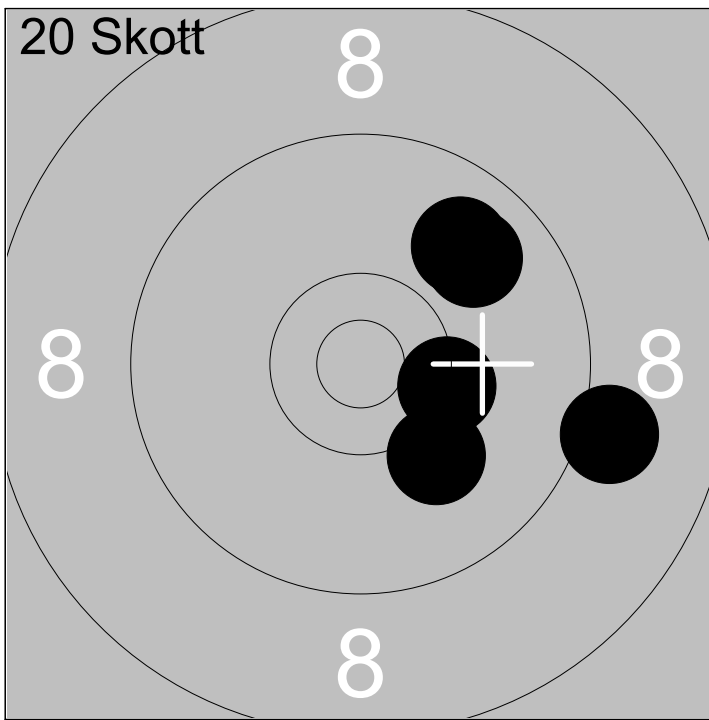

6:	10.3x	→
7:	9.8	↗
8:	9.1	→
9:	9.8	↗
10:	10.1	↘

Serie	47
Total	94

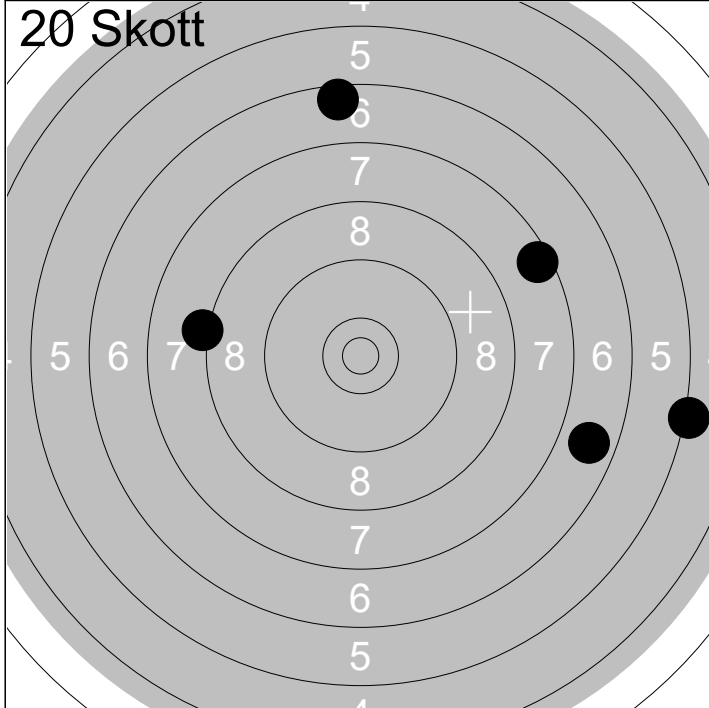

11:	5.2	→
12:	6.5	↑
13:	8.2	←
14:	7.5	↗
15:	6.8	↘

Serie	32
Total	126

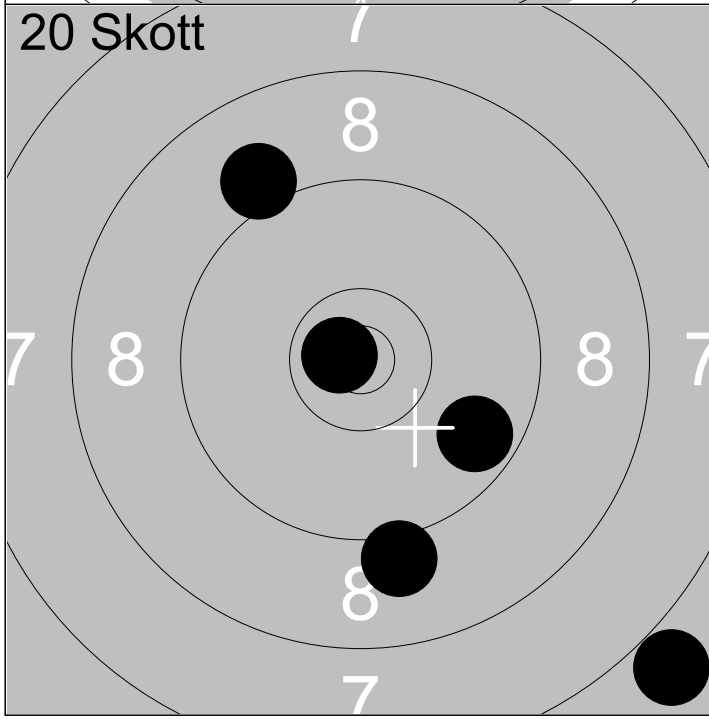

16:	10.8x	←
17:	9.1	↘
18:	9.7	↘
19:	9.1	↗
20:	6.9	↘

Serie	43
Total	169

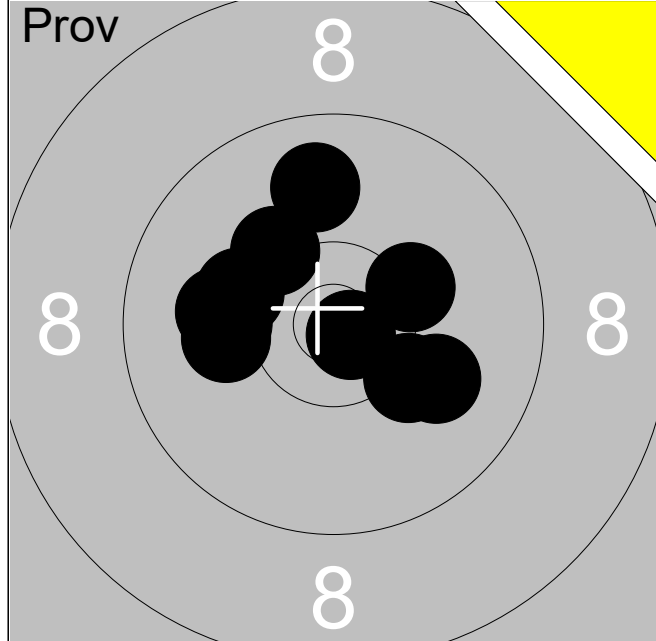

1:	10.2	↘
2:	10.2	↖
3:	10.1	←
4:	10.8x	↘
5:	10.0	↘
6:	10.3	↗
7:	10.1	←
8:	10.2	↗
9:	9.9	↑
10:	10.1	←

Serie	99
-------	----

Total	0
-------	---

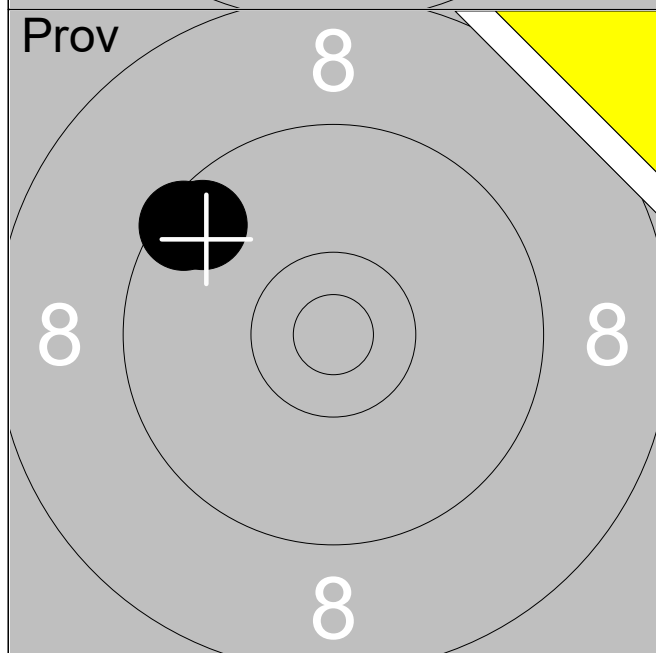

11:	9.5	↗
12:	9.6	↗

Serie	18
-------	----

Total	0
-------	---

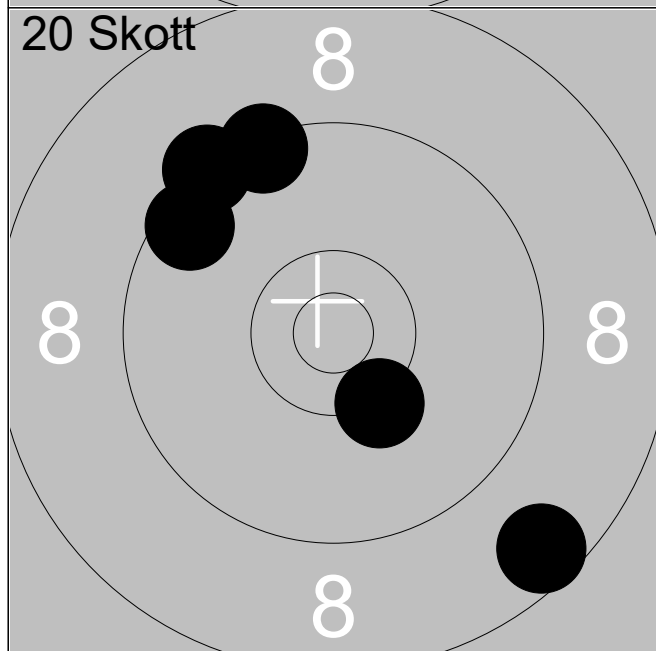

1:	9.5	↗
2:	9.4	↗
3:	9.3	↗
4:	8.6	↘
5:	10.3x	↘

Serie	45
-------	----

Total	45
-------	----

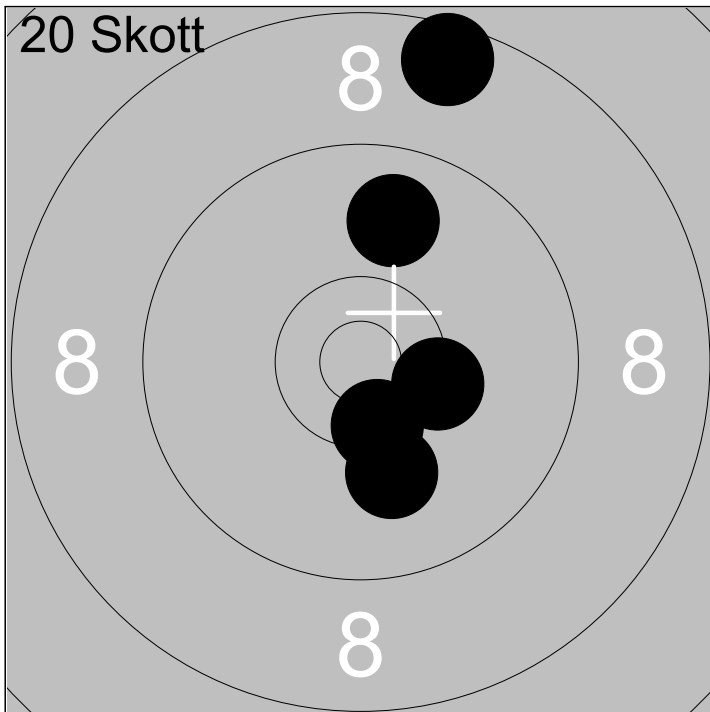

6:	10.5x	↓
7:	10.1	↓
8:	10.3x	→
9:	8.6	↑
10:	9.8	↑

Serie 47

Total 92

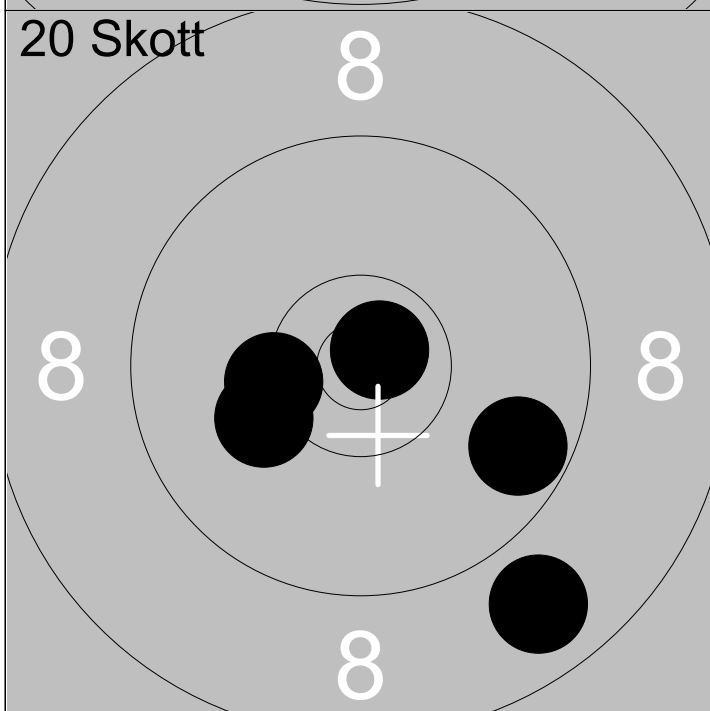

11:	10.3x	←
12:	10.8x	↗
13:	8.8	↓
14:	10.2	←
15:	9.7	↘

Serie 47

Total 139

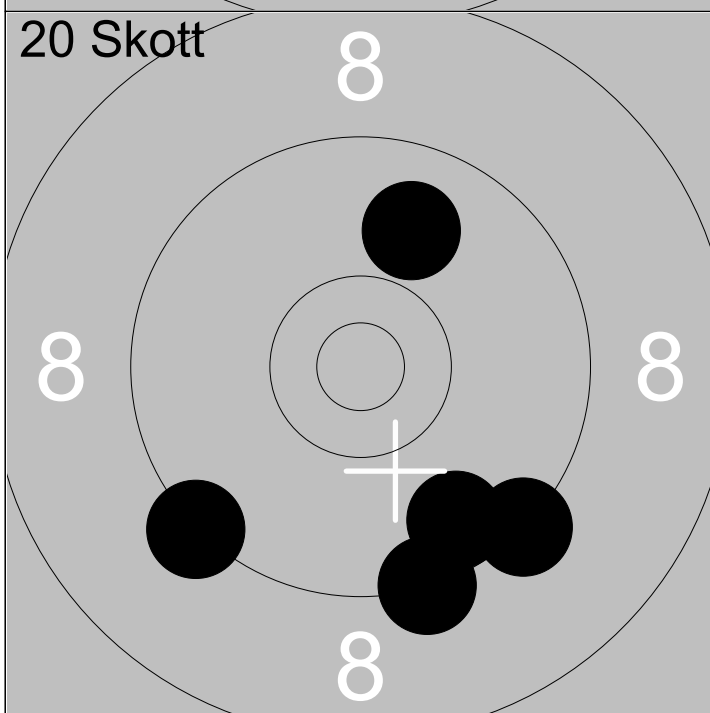

16:	9.3	↙
17:	9.7	↓
18:	9.3	↘
19:	9.9	↑
20:	9.3	↓

Serie 45

Total 184

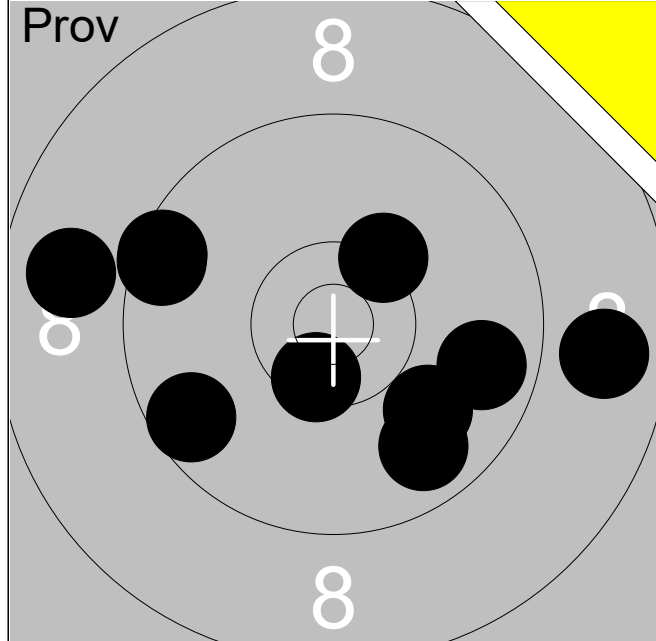

1:	8.8	→
2:	9.6	↙
3:	9.5	↖
4:	10.5x	↘
5:	9.8	↘
6:	9.9	↘
7:	9.5	↖
8:	8.9	↖
9:	9.7	→
10:	10.3x	↗

Serie	90
-------	----

Total	0
-------	---

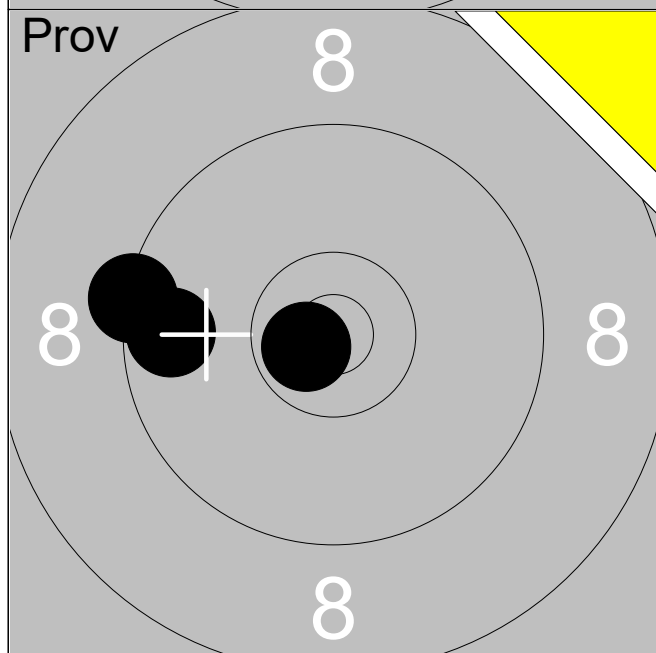

11:	9.7	←
12:	10.7x	←
13:	9.3	←

Serie	28
-------	----

Total	0
-------	---

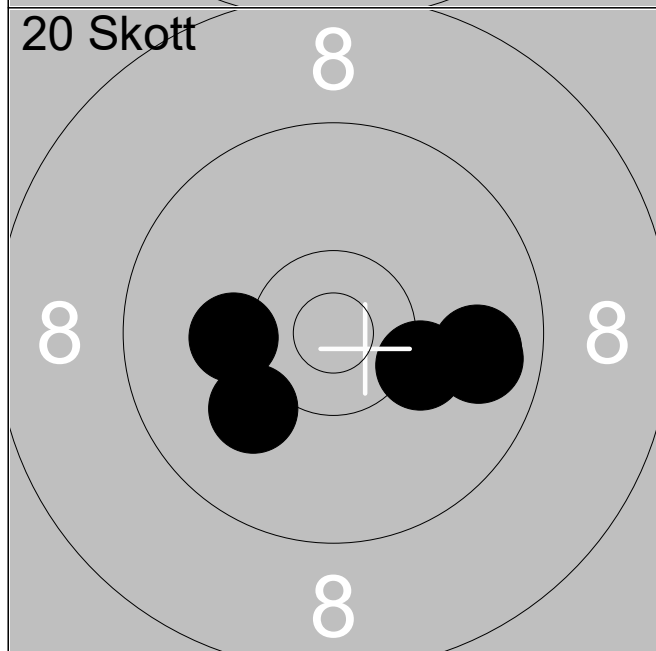

1:	10.1	↙
2:	9.8	→
3:	10.2	←
4:	9.8	→
5:	10.2	↘

Serie	48
-------	----

Total	48
-------	----

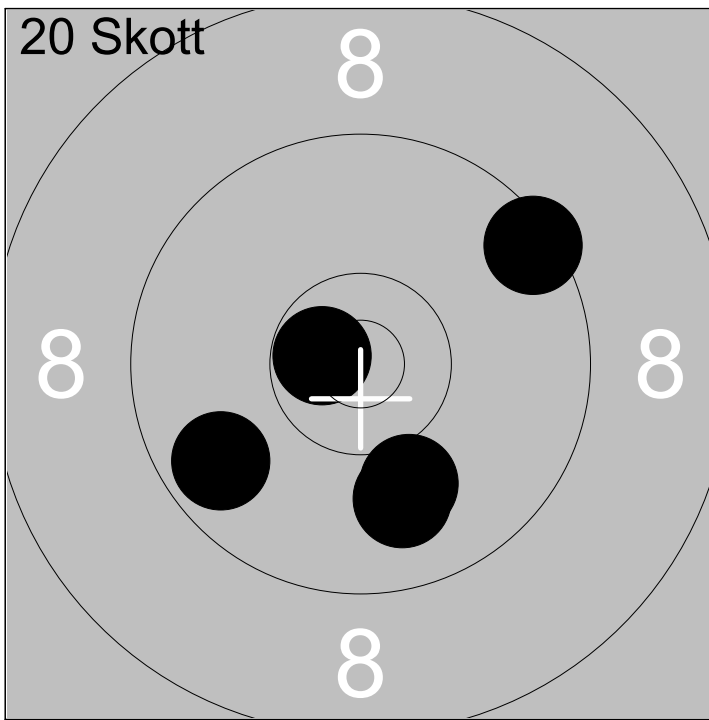

6:	9.7	↙
7:	9.9	↓
8:	9.5	↗
9:	10.7x	↖
10:	10.0	↓

Serie	47
Total	95

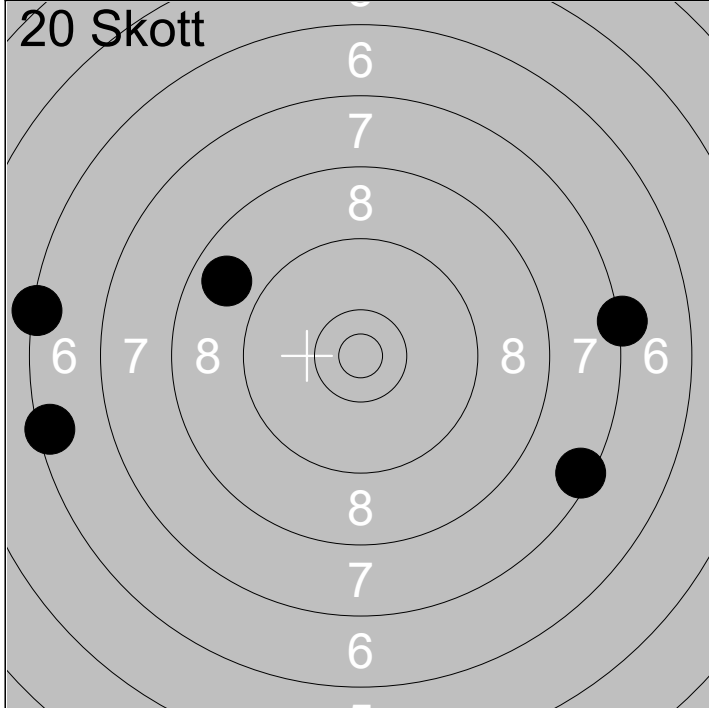

11:	6.4	↖
12:	6.5	↖
13:	8.8	↗
14:	7.2	→
15:	7.4	↘

Serie	34
Total	129

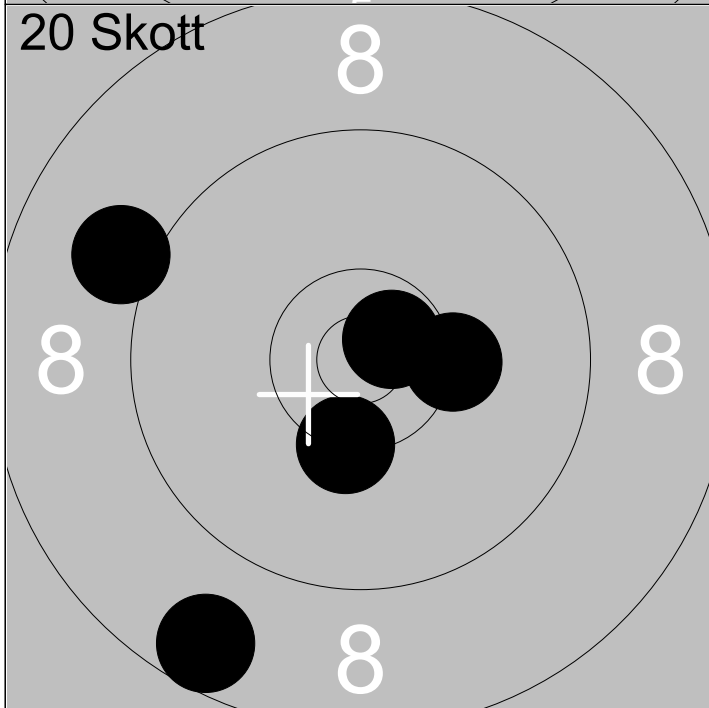

16:	8.6	↘
17:	9.1	↖
18:	10.7x	↗
19:	10.3x	↓
20:	10.3	→

Serie	47
Total	176



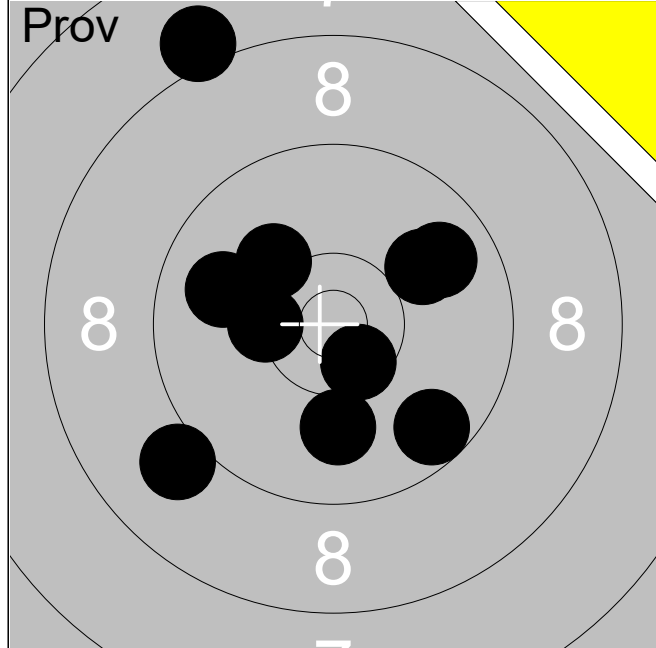

1:	10.0	↗
2:	9.9	↖
3:	10.2	↗
4:	9.8	↗
5:	9.6	↘
6:	10.3x	↖
7:	9.0	↘
8:	10.5x	↘
9:	8.1	↗
10:	10.0	↓

Serie	<b>94</b>
-------	-----------

Total	<b>0</b>
-------	----------

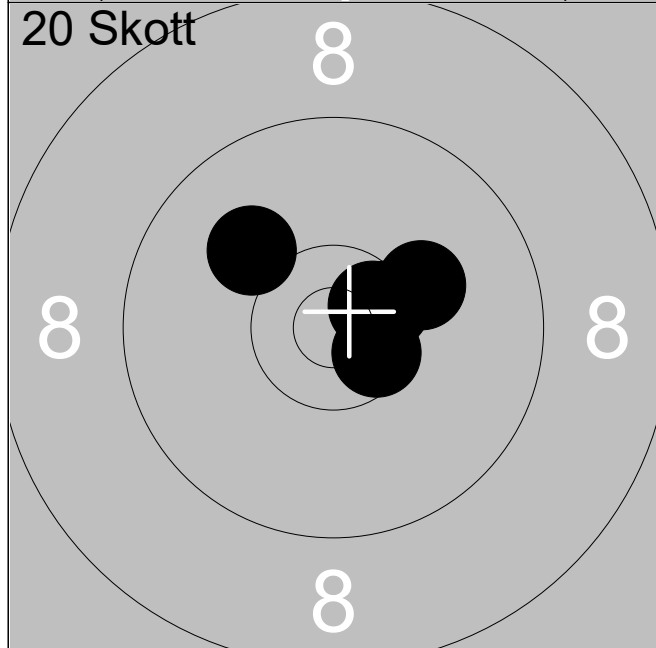

1:	10.6x	↘
2:	10.2	↗
3:	10.1	↗
4:	10.5x	↗
5:	10.6x	↗

Serie	<b>50</b>
-------	-----------

Total	<b>50</b>
-------	-----------

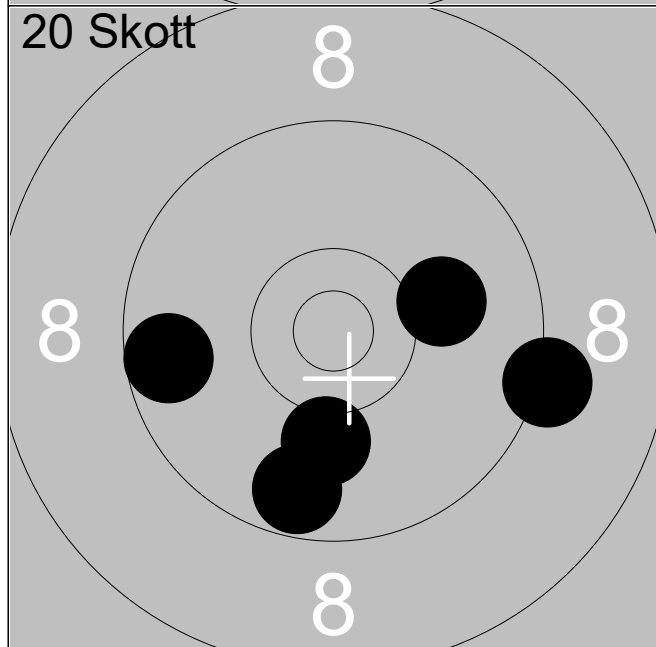

6:	10.1	↓
7:	10.1	→
8:	9.2	→
9:	9.6	↖
10:	9.7	↓

Serie	<b>47</b>
-------	-----------

Total	<b>97</b>
-------	-----------

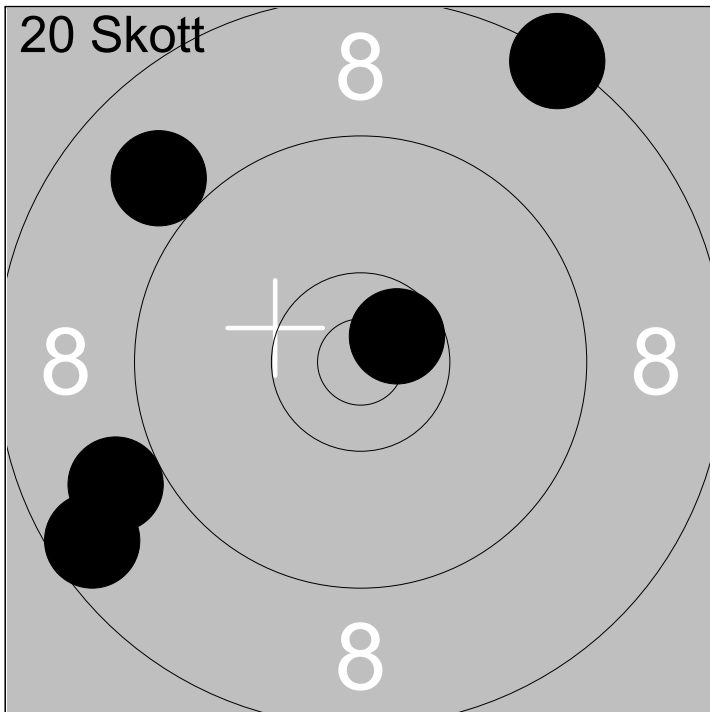

11:	8.3	↗
12:	8.6	↙
13:	9.0	↖
14:	9.0	↙
15:	10.6x	↗

Serie 44

Total 141

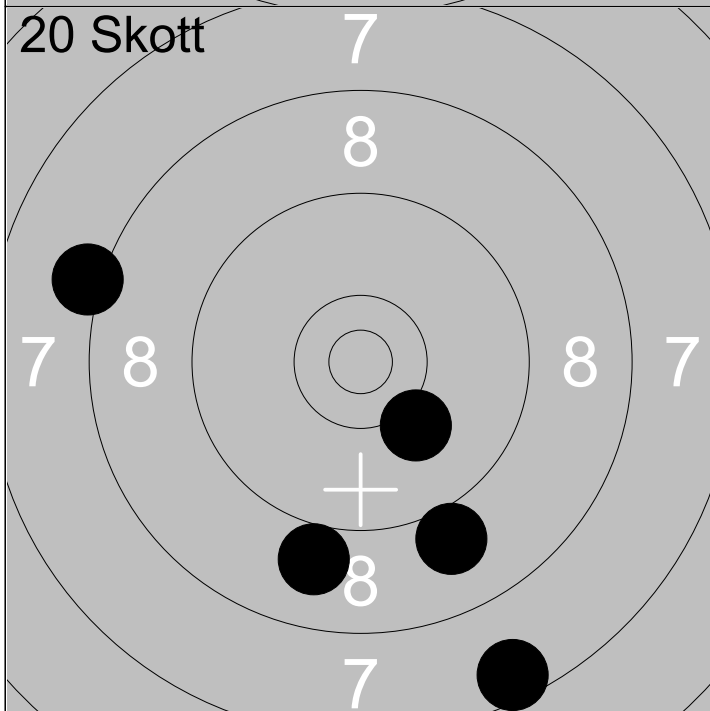

16:	9.0	↘
17:	8.2	↖
18:	10.1	↘
19:	7.6	↘
20:	9.0	↘

Serie 43

Total 184

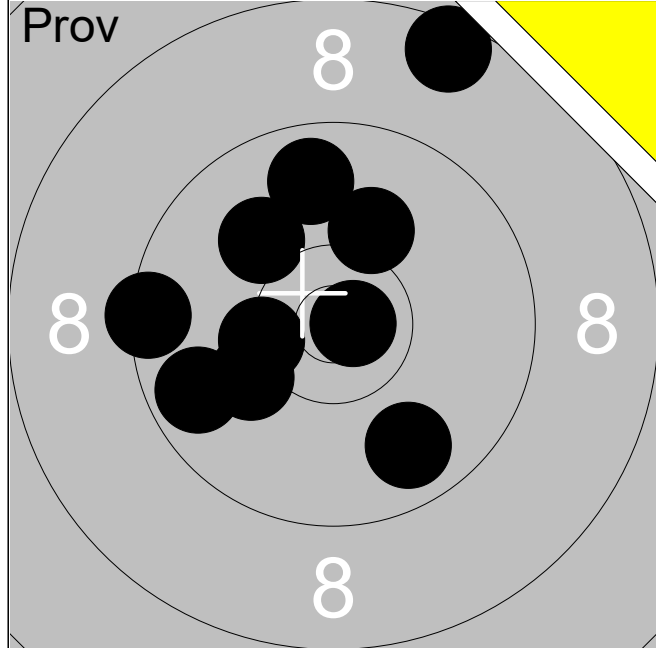

1:	9.7	↙
2:	10.3x	←
3:	9.4	←
4:	10.0	↗
5:	10.1	↗
6:	8.5	↗
7:	10.2	↙
8:	9.8	↑
9:	9.8	↘
10:	10.8x	→
<b>Serie</b>		<b>94</b>
<b>Total</b>		<b>0</b>

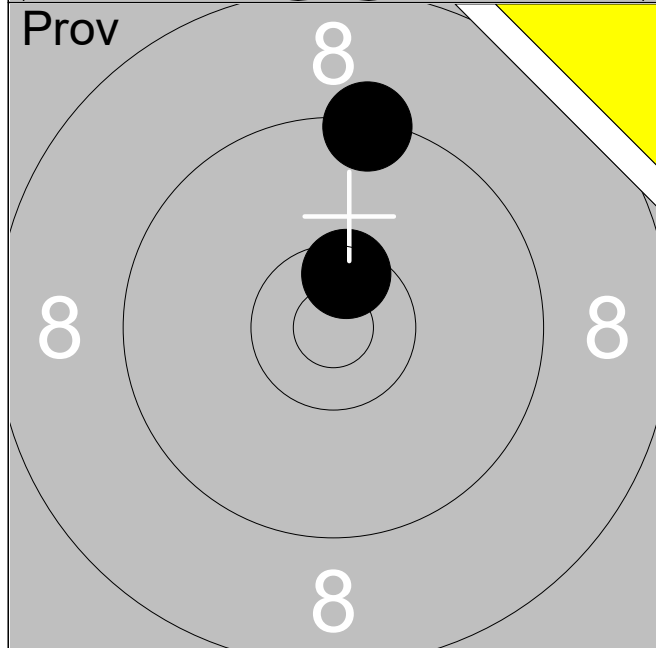

11:	9.4	↑
12:	10.5x	↑
<b>Serie</b>		<b>19</b>
<b>Total</b>		<b>0</b>

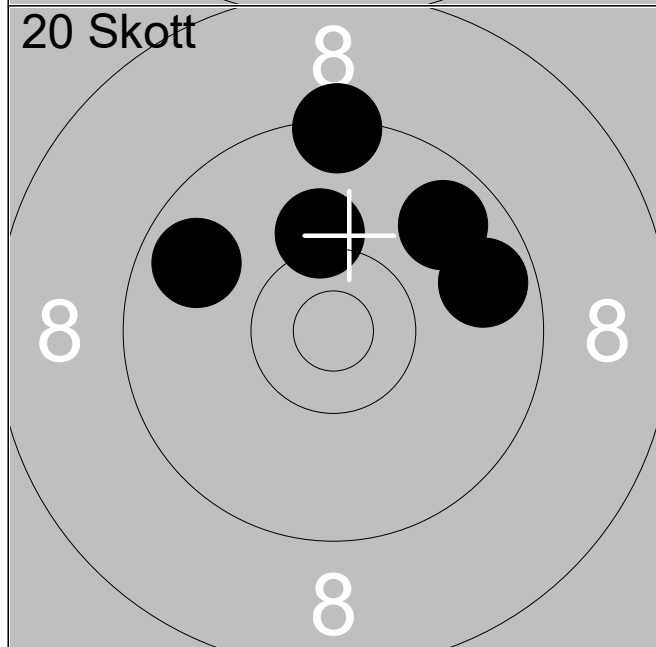

1:	10.2	↑
2:	9.4	↑
3:	9.7	↙
4:	9.8	↗
5:	9.7	→
<b>Serie</b>		<b>46</b>
<b>Total</b>		<b>46</b>

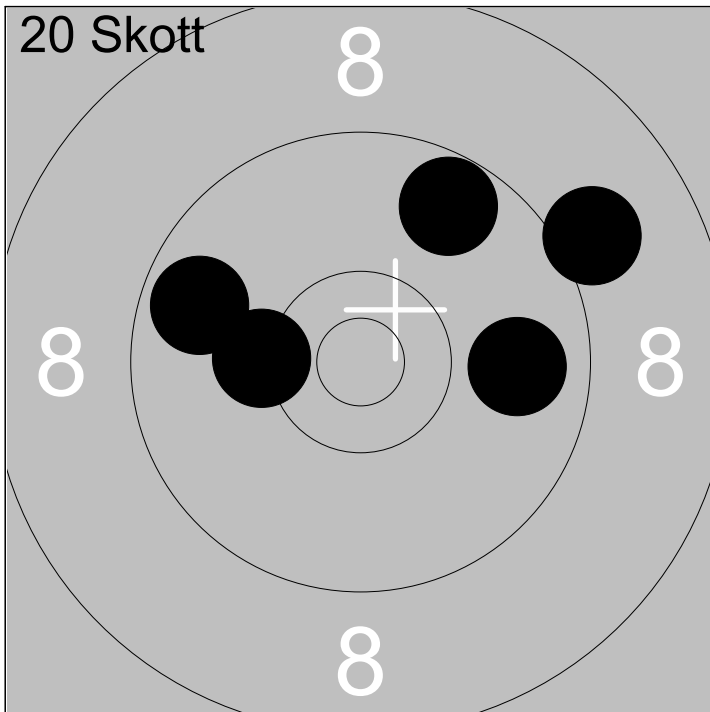

6:	9.8	→
7:	9.1	↗
8:	10.2	←
9:	9.7	↖
10:	9.7	↗

Serie	46
Total	92

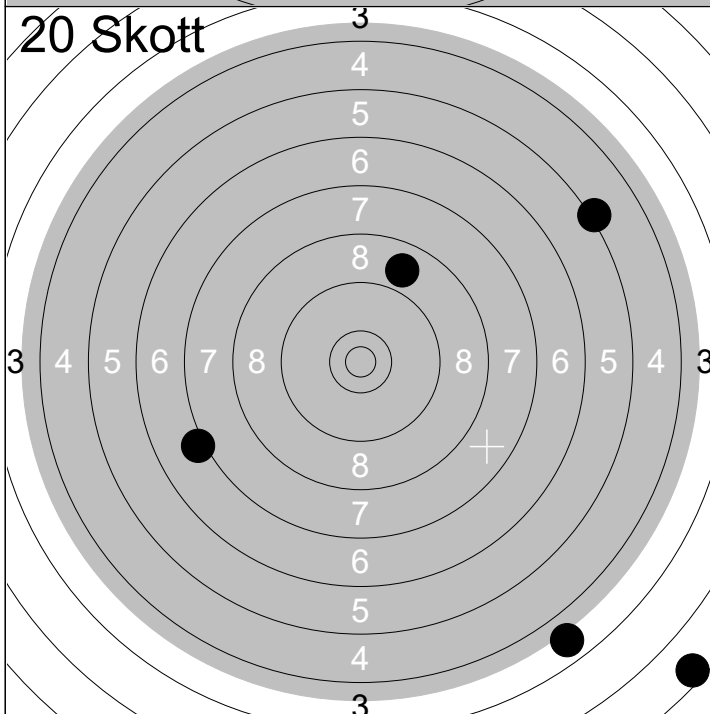

11:	7.1	↖
12:	3.8	↘
13:	8.9	↗
14:	5.2	↗
15:	1.6	↘

Serie	24
Total	116

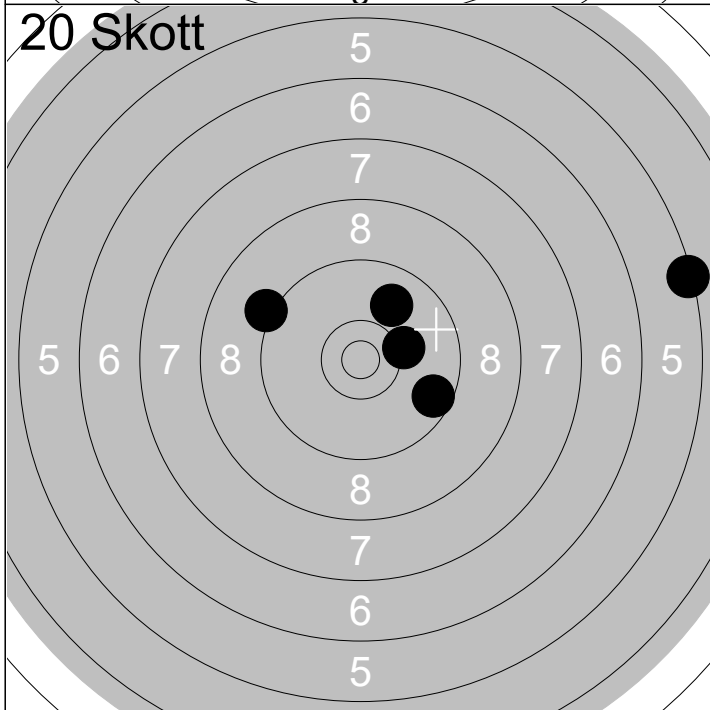

16:	9.9	↗
17:	9.2	↖
18:	9.6	↘
19:	10.2	→
20:	5.4	→

Serie	42
Total	158

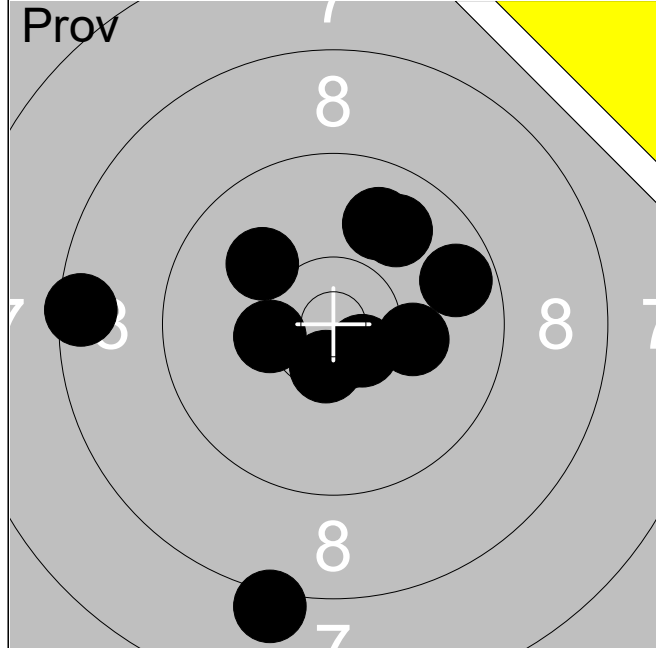

1:	8.2	↓
2:	8.5	←
3:	10.0	↗
4:	10.3x	←
5:	10.5x	↓
6:	10.6x	↘
7:	9.7	→
8:	9.9	↗
9:	10.2	→
10:	9.9	↗

Serie **93**

Total **0**

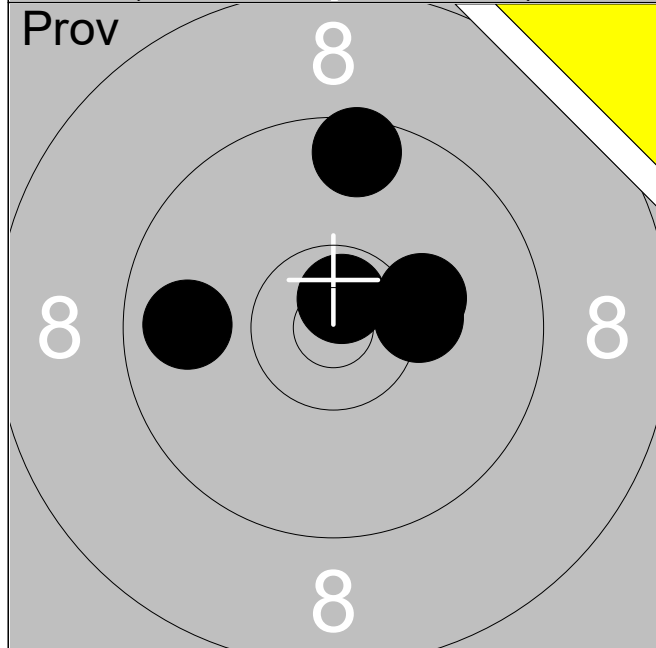

11:	10.7x	↑
12:	10.3	→
13:	9.6	↑
14:	10.2	→
15:	9.8	←

Serie **48**

Total **0**

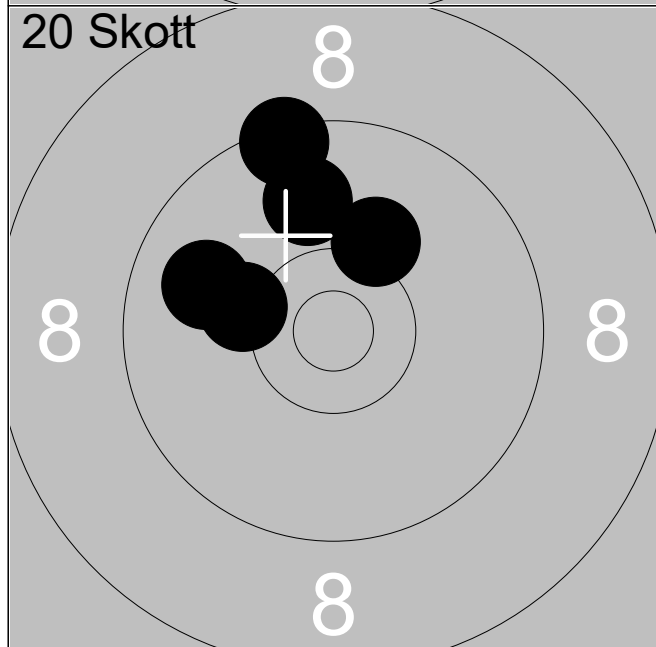

1:	9.9	↑
2:	9.4	↑
3:	10.2	↗
4:	10.2	←
5:	9.9	←

Serie **47**

Total **47**

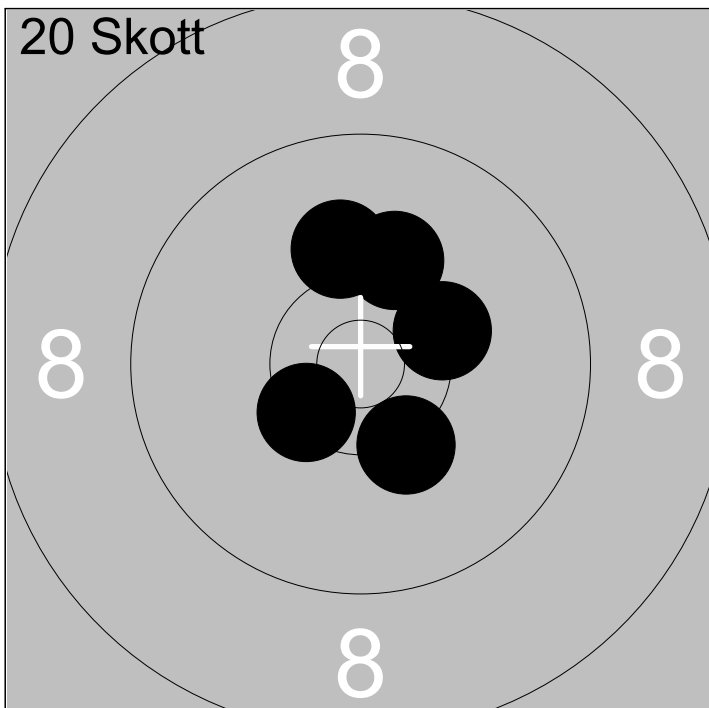

6:	10.4x	↙
7:	10.2	↑
8:	10.3x	➔
9:	10.3x	↘
10:	10.1	↑

Serie	50
Total	97

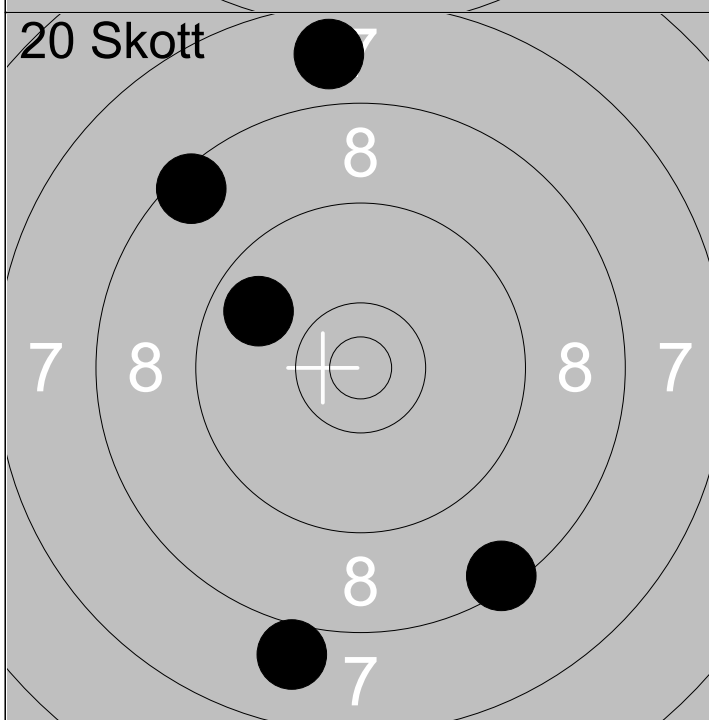

11:	8.0	↘
12:	8.5	➔
13:	7.8	↑
14:	8.4	↘
15:	9.8	↗

Serie	40
Total	137

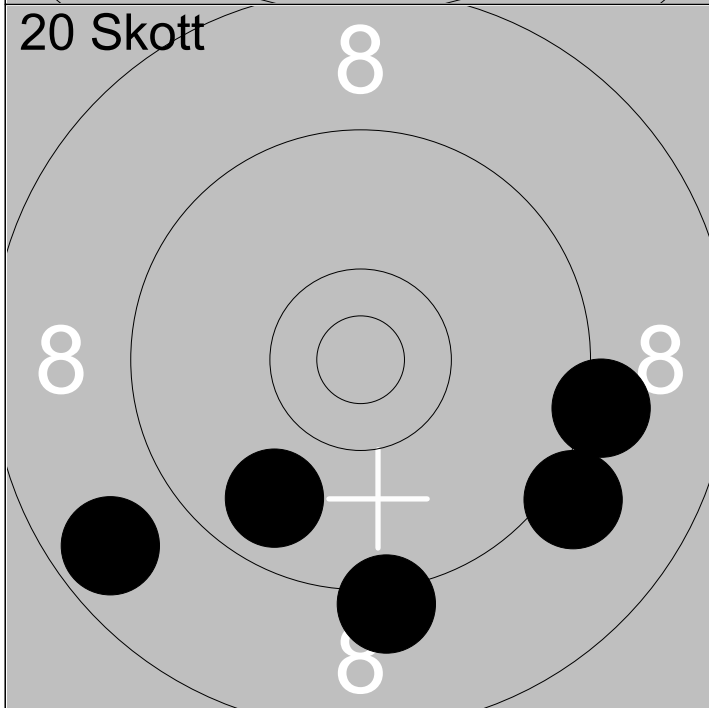

16:	9.2	➔
17:	9.2	↘
18:	9.8	↘
19:	9.1	↘
20:	8.7	↙

Serie	44
Total	181



1:	8.5	↗
2:	10.2	←
3:	10.4x	→
4:	9.7	←
5:	10.6x	↗
6:	10.6x	↖
7:	10.0	↗
8:	9.8	↘
9:	10.2	↘
10:	10.4x	←

Serie	<b>96</b>
-------	-----------

Total	<b>0</b>
-------	----------

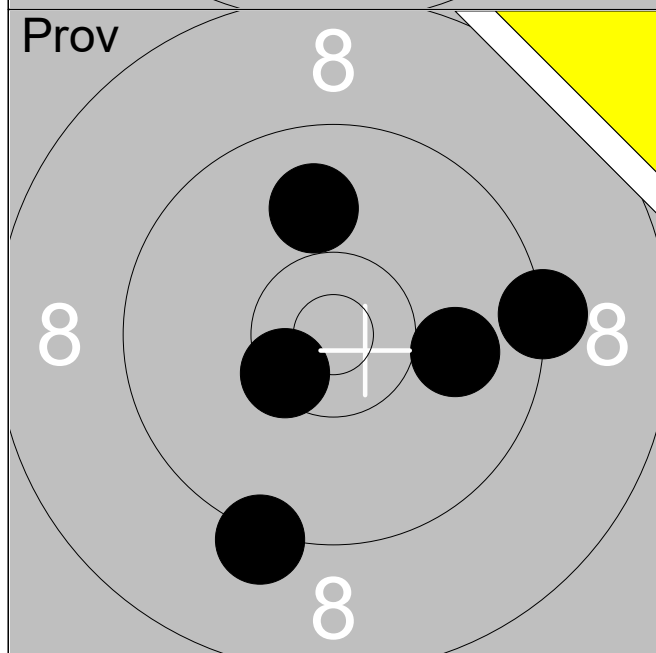

11:	9.3	→
12:	9.2	↘
13:	10.0	→
14:	10.5x	↖
15:	9.9	↑

Serie	<b>47</b>
-------	-----------

Total	<b>0</b>
-------	----------

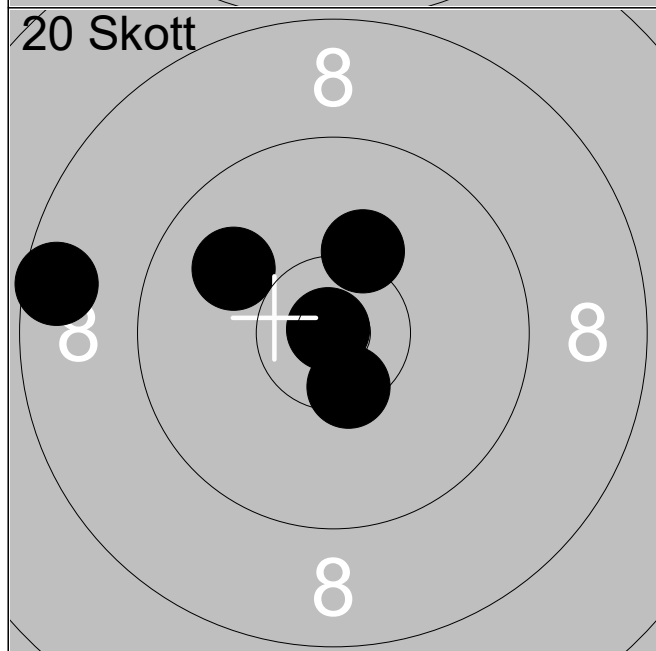

1:	10.2	↗
2:	10.5x	↘
3:	9.9	↖
4:	8.6	←
5:	10.9x	↗

Serie	<b>47</b>
-------	-----------

Total	<b>47</b>
-------	-----------

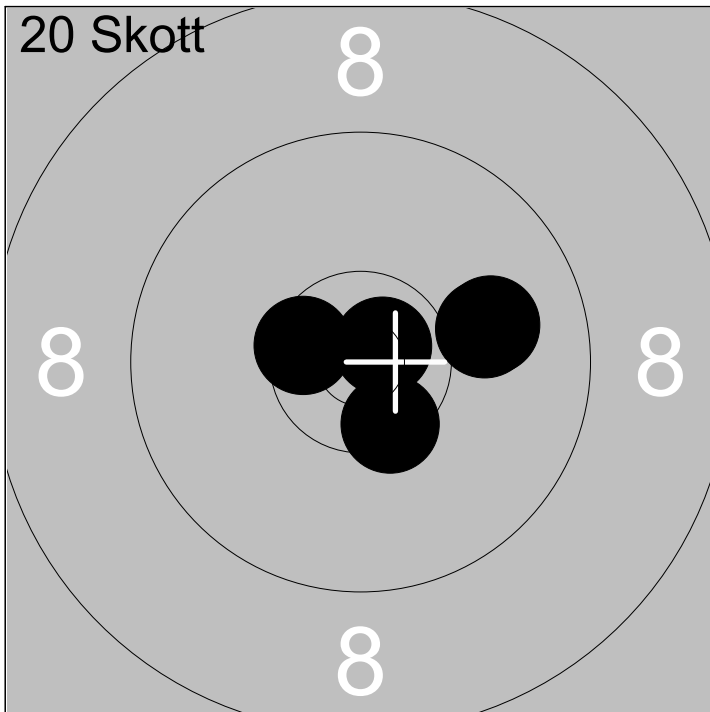

6:	10.0	→
7:	10.0	→
8:	10.8x	↗
9:	10.5x	↘
10:	10.5x	←

Serie 50

Total 97

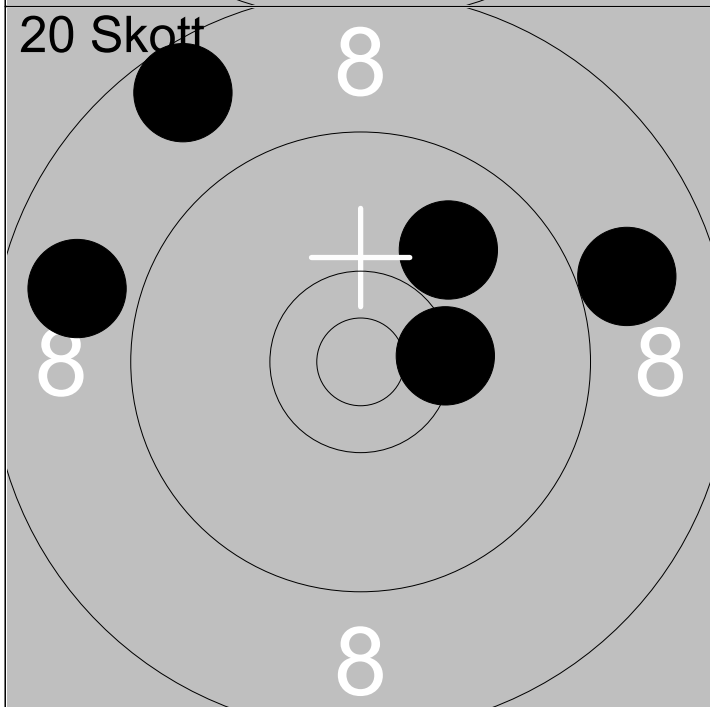

11:	10.3x	→
12:	8.6	↗
13:	8.9	→
14:	9.9	↗
15:	8.8	←

Serie 43

Total 140

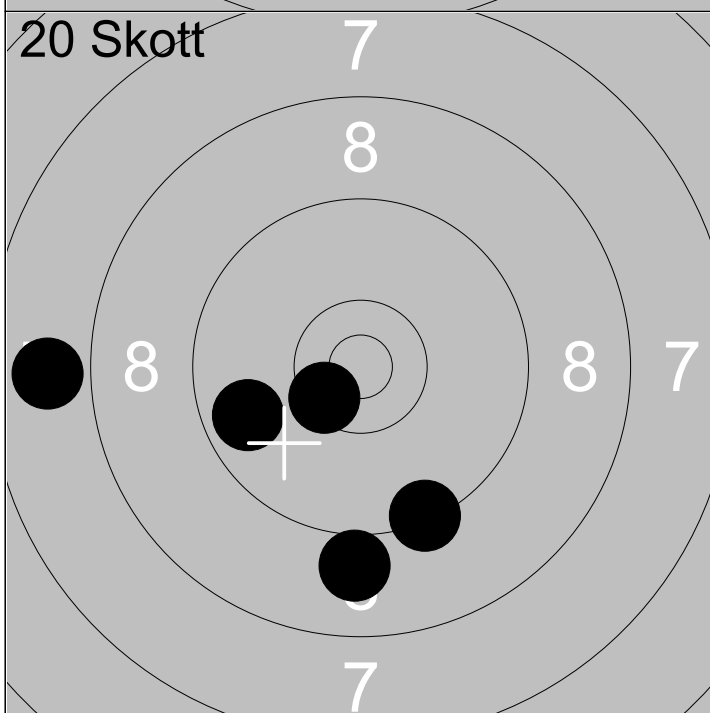

16:	9.0	↓
17:	7.9	←
18:	9.8	←
19:	9.4	↘
20:	10.5x	↙

Serie 44

Total 184



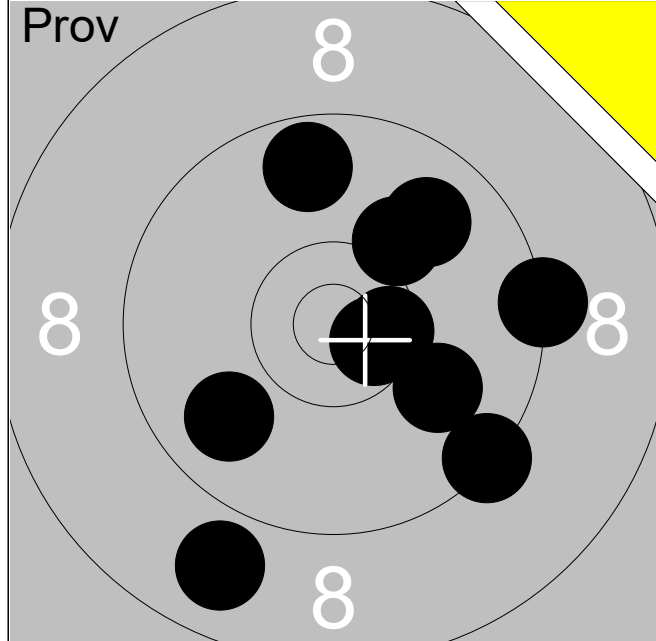

1:	10.6x	→
2:	9.7	↑
3:	9.9	↙
4:	10.1	↗
5:	9.3	→
6:	9.9	↗
7:	10.5x	→
8:	8.9	↘
9:	9.4	↘
10:	10.0	↘

Serie	<b>93</b>
-------	-----------

Total	<b>0</b>
-------	----------

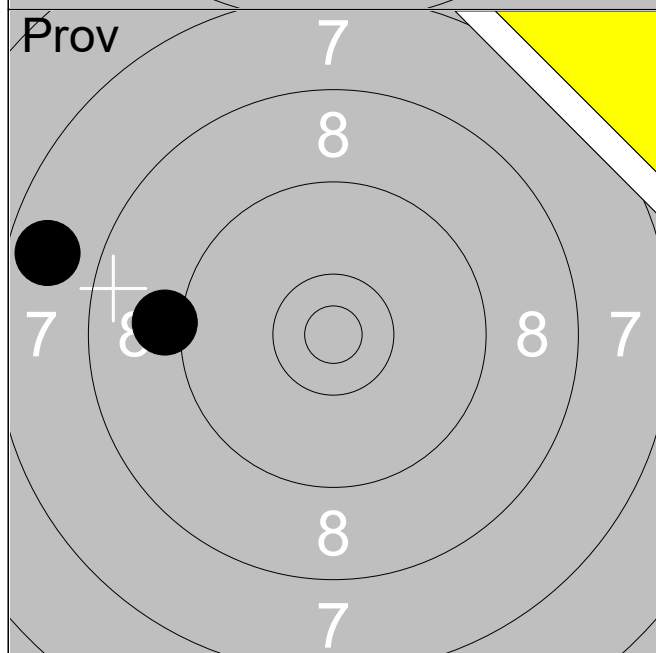

11:	7.7	←
12:	9.1	←

Serie	<b>16</b>
-------	-----------

Total	<b>0</b>
-------	----------

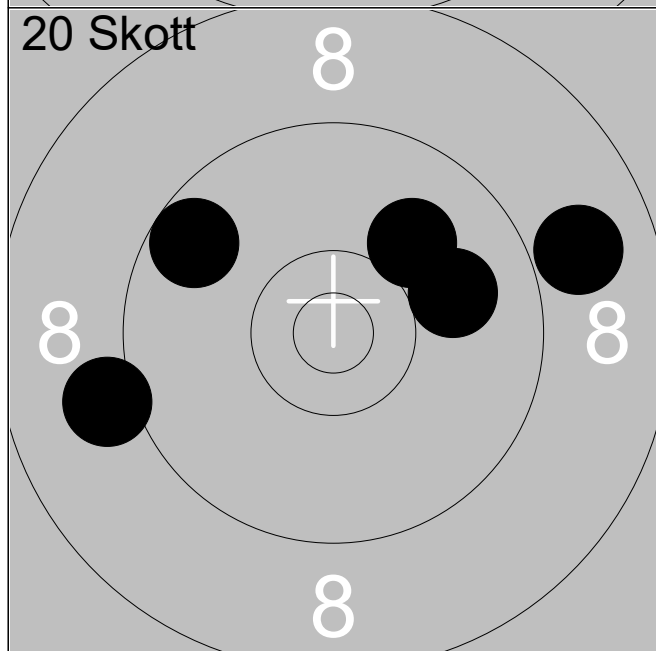

1:	9.6	↖
2:	9.1	←
3:	10.0	→
4:	8.9	→
5:	10.0	↗

Serie	<b>46</b>
-------	-----------

Total	<b>46</b>
-------	-----------

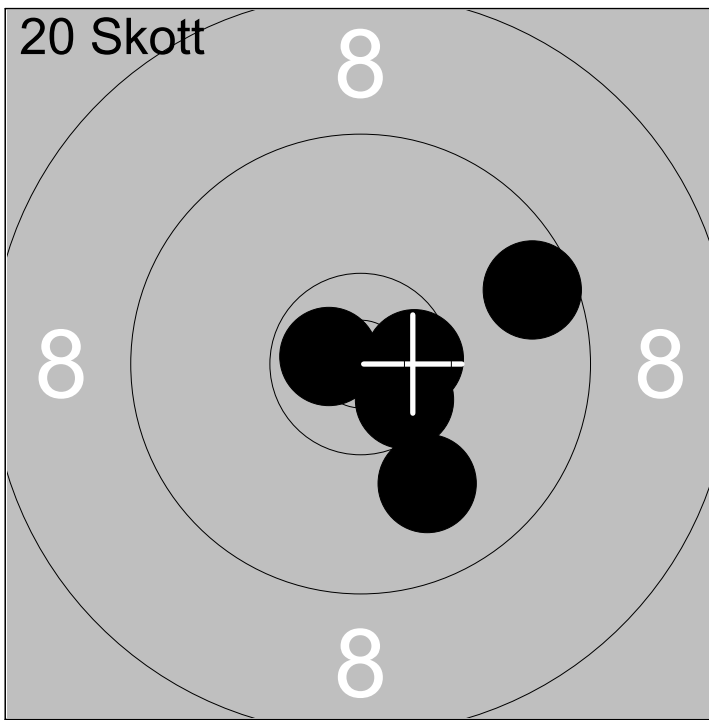

6:	10.6x	→
7:	9.6	↗
8:	10.7x	↖
9:	10.0	↘
10:	10.5x	↙

Serie	49
Total	95

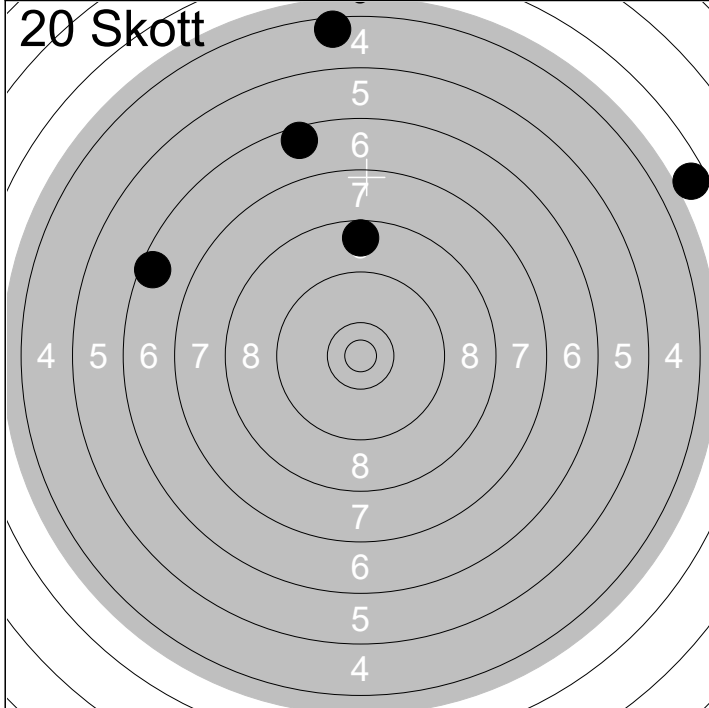

11:	6.5	↖
12:	3.6	↗
13:	4.5	↑
14:	6.6	↗
15:	8.6	↑

Serie	27
Total	122

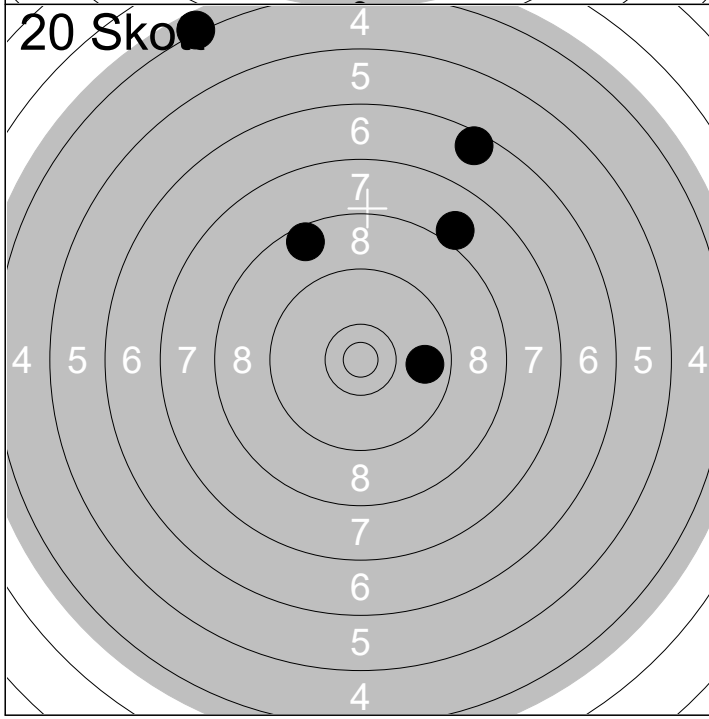

16:	4.2	↖
17:	8.0	↗
18:	6.5	↗
19:	9.8	→
20:	8.6	↖

Serie	35
Total	157

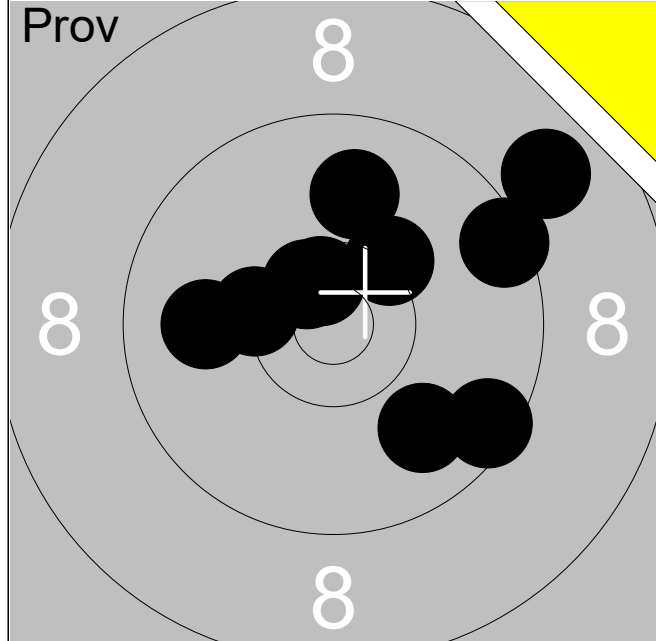

1:	10.3x	←
2:	9.9	↑
3:	10.6x	↗
4:	9.5	→
5:	10.6x	↑
6:	9.9	←
7:	9.5	↘
8:	9.9	↘
9:	8.9	↗
10:	10.3	↗

Serie	<b>93</b>
-------	-----------

Total	<b>0</b>
-------	----------

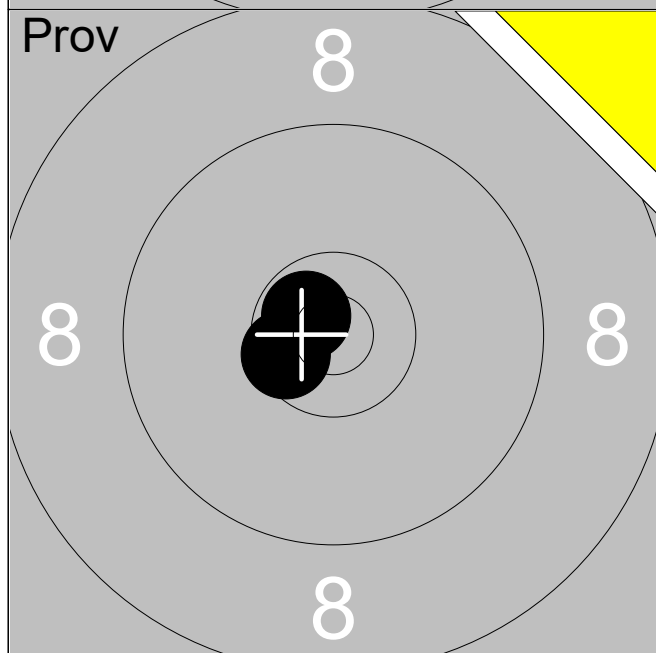

11:	10.5x	←
12:	10.7x	↖

Serie	<b>20</b>
-------	-----------

Total	<b>0</b>
-------	----------

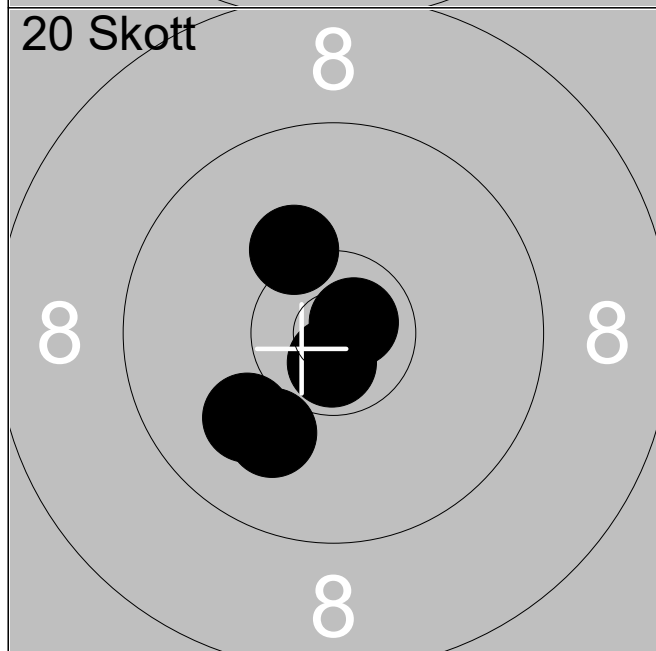

1:	10.2	↖
2:	10.7x	↓
3:	10.0	↙
4:	10.0	↓
5:	10.8x	↗

Serie	<b>50</b>
-------	-----------

Total	<b>50</b>
-------	-----------

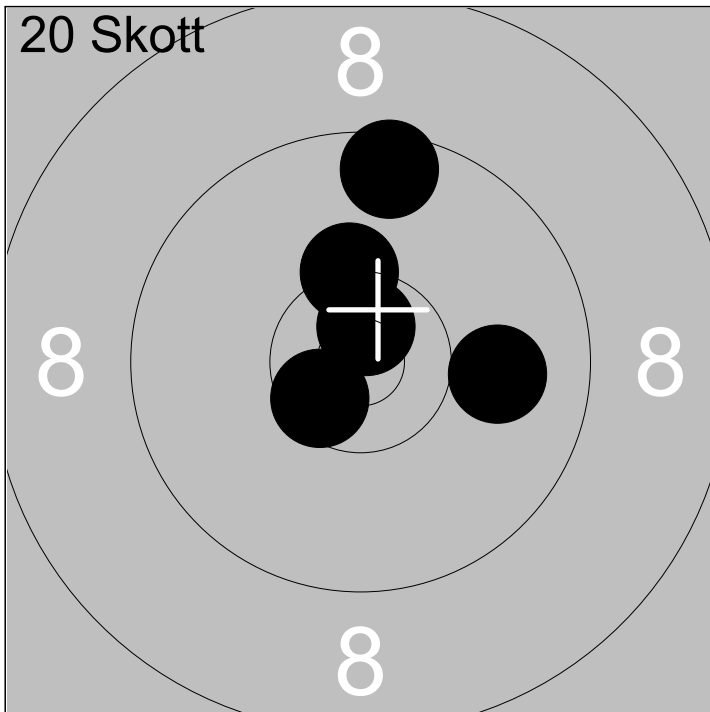

6:	9.5	↑
7:	10.6x	↙
8:	10.3x	↑
9:	10.0	→
10:	10.7x	↑

Serie 49

Total 99

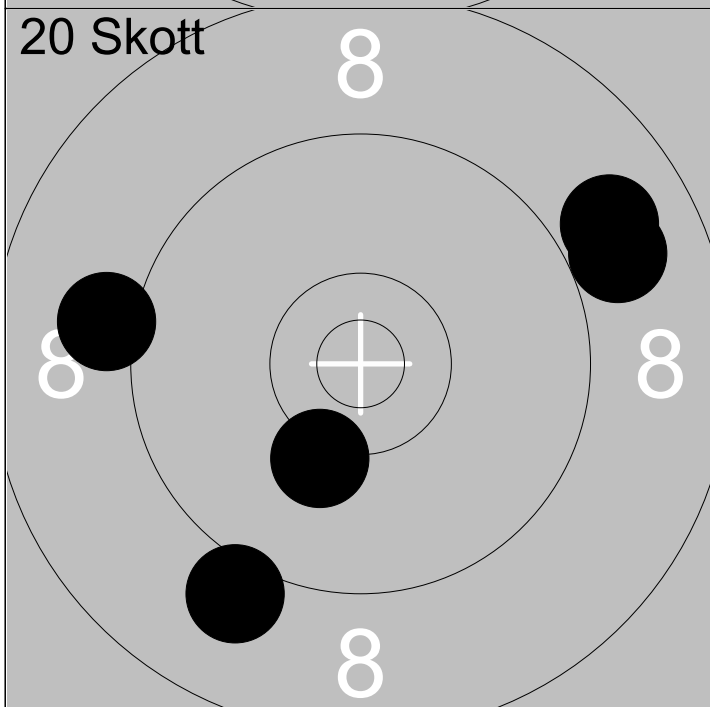

11:	10.2	↘
12:	8.9	↗
13:	8.9	↗
14:	9.1	↘
15:	9.1	←

Serie 44

Total 143

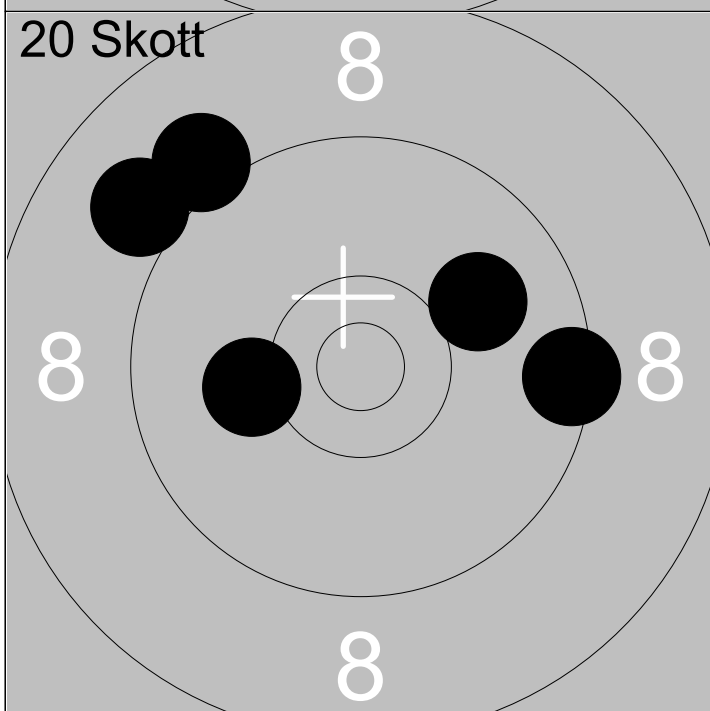

16:	9.4	→
17:	10.0	↗
18:	9.0	↖
19:	10.2	←
20:	9.1	↖

Serie 47

Total 190

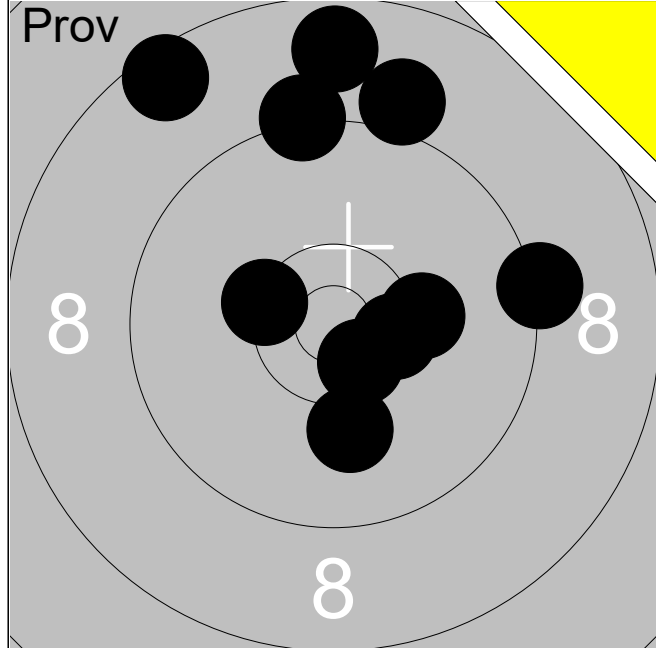

1:	10.4x	↖
2:	8.7	↑
3:	8.5	↗
4:	9.3	↑
5:	9.1	↑
6:	9.2	→
7:	10.4x	→
8:	10.2	→
9:	10.1	↓
10:	10.6x	↓

Serie	<b>93</b>
-------	-----------

Total	<b>0</b>
-------	----------

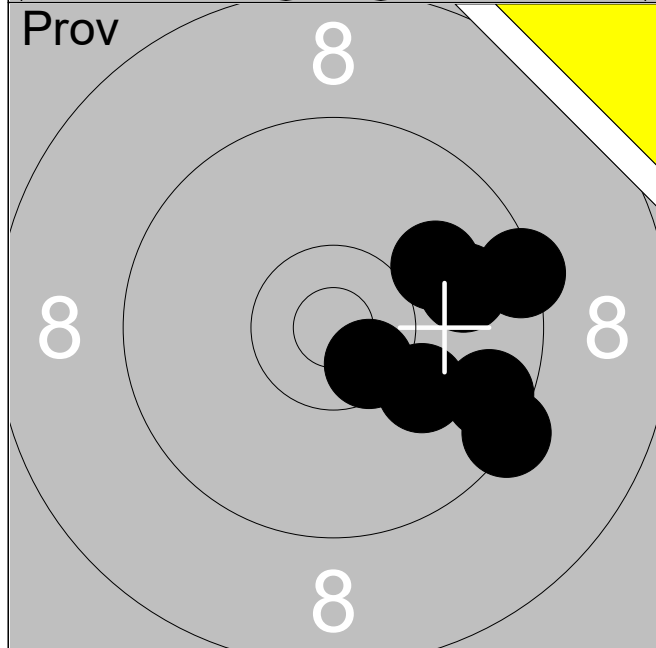

11:	9.4	↘
12:	9.4	→
13:	9.6	↘
14:	9.9	→
15:	10.0	↗
16:	10.1	↘
17:	10.6x	↘

Serie	<b>66</b>
-------	-----------

Total	<b>0</b>
-------	----------

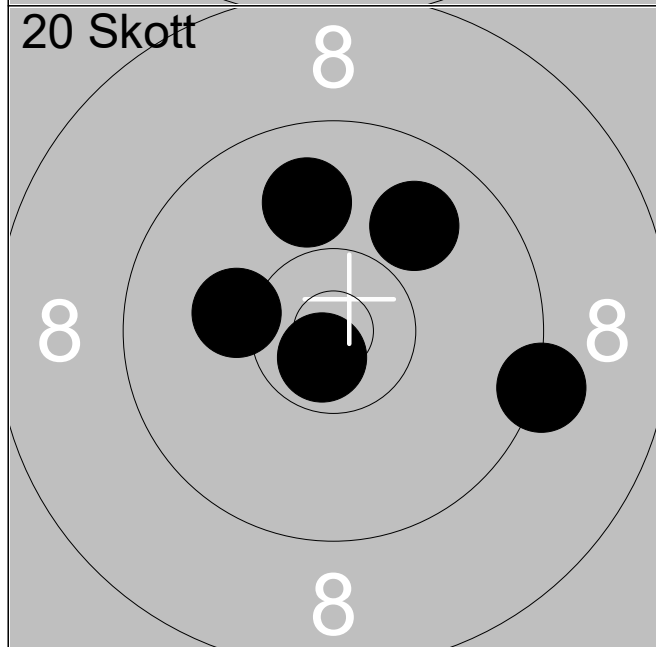

1:	9.9	↑
2:	10.2	↖
3:	10.7x	↓
4:	9.3	→
5:	9.9	↗

Serie	<b>47</b>
-------	-----------

Total	<b>47</b>
-------	-----------

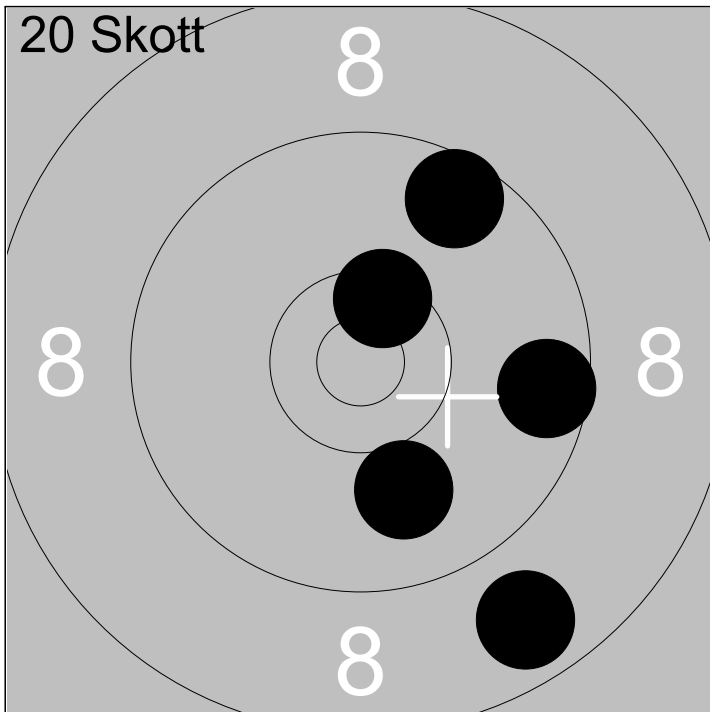

6:	9.6	→
7:	8.8	↘
8:	10.0	↘
9:	9.6	↗
10:	10.5x	↗

Serie	46
Total	93

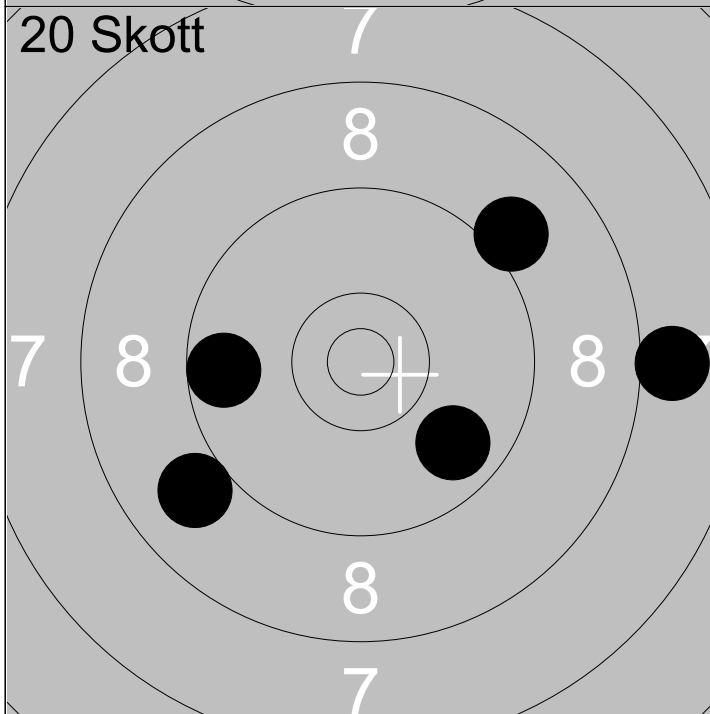

11:	9.0	↙
12:	8.0	→
13:	9.1	↗
14:	9.8	↘
15:	9.7	←

Serie	44
Total	137

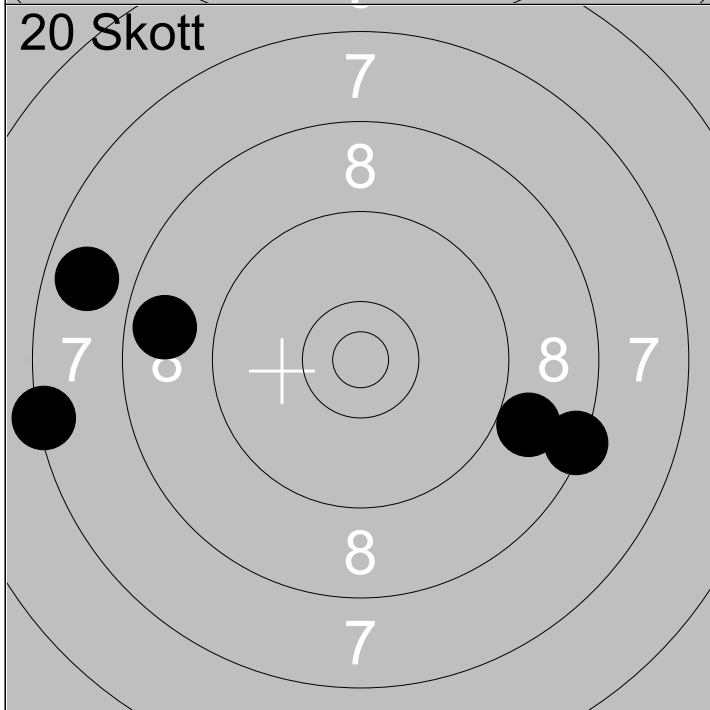

16:	8.7	↙
17:	7.4	↙
18:	7.8	↙
19:	8.9	↘
20:	8.4	↘

Serie	38
Total	175

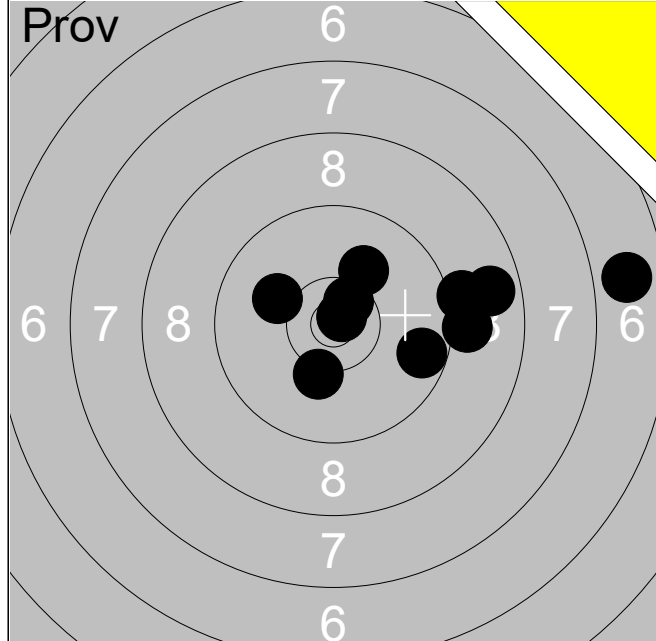

1:	6.8	→
2:	9.1	→
3:	9.7	→
4:	8.7	→
5:	10.8x	↗
6:	10.1	↖
7:	10.2	↓
8:	9.1	→
9:	10.1	↗
10:	10.6x	↗
<b>Serie</b>		<b>91</b>
<b>Total</b>		<b>0</b>

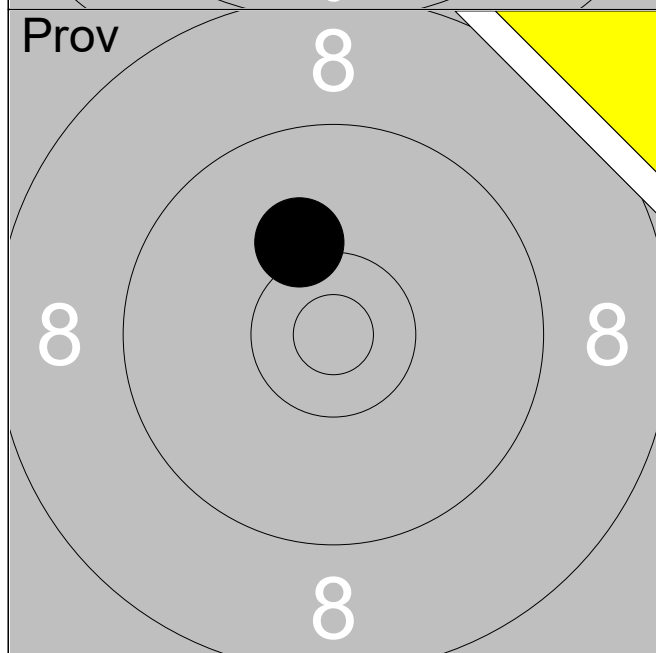

11:	10.2	↖
<b>Serie</b>		<b>10</b>
<b>Total</b>		<b>0</b>

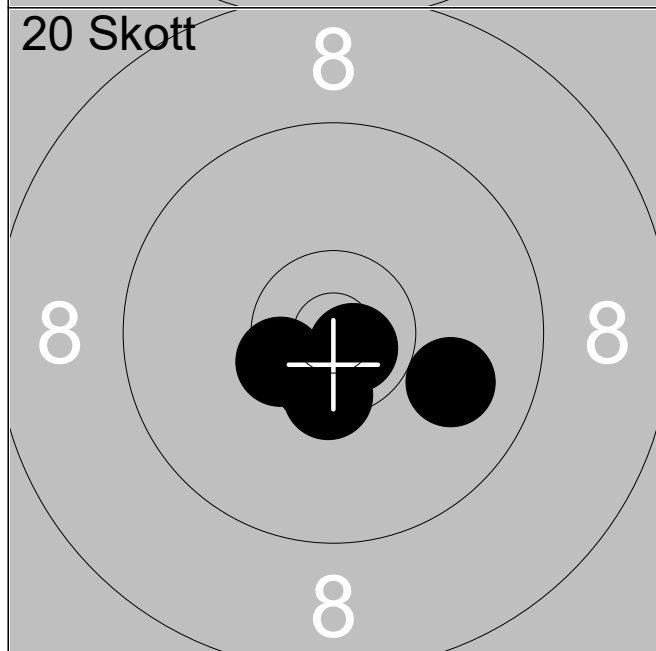

1:	10.6x	↓
2:	10.5x	↓
3:	10.5x	↖
4:	10.0	→
5:	10.8x	↘
<b>Serie</b>		<b>50</b>
<b>Total</b>		<b>50</b>

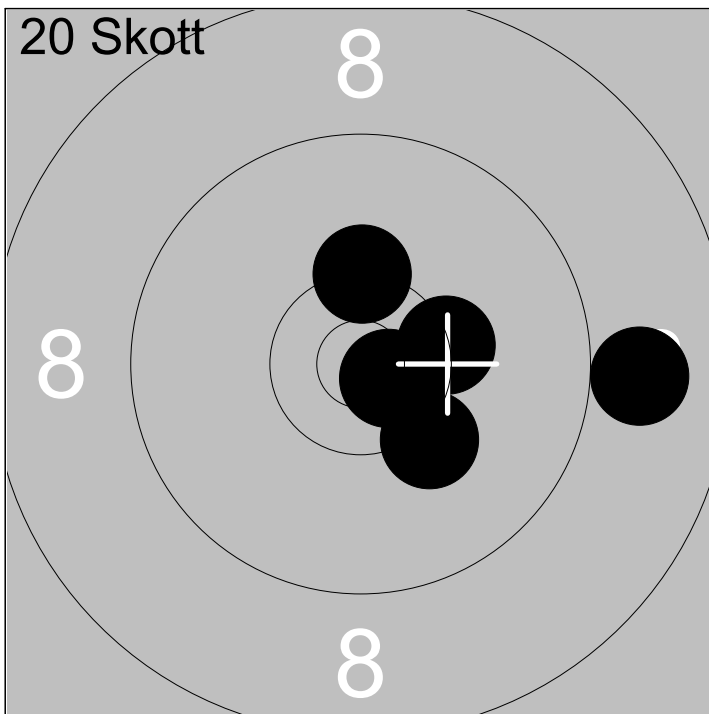

6:	10.3x	→
7:	10.3x	↑
8:	10.2	↘
9:	10.7x	↘
10:	8.9	→

Serie	48
Total	98

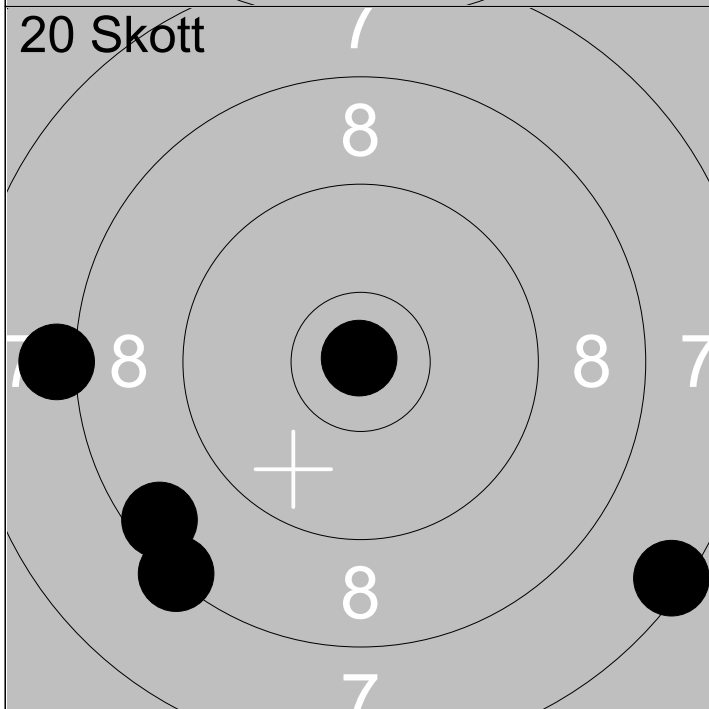

11:	7.4	↘
12:	8.1	←
13:	8.6	↘
14:	8.3	↘
15:	10.9x	↑

Serie	41
Total	139

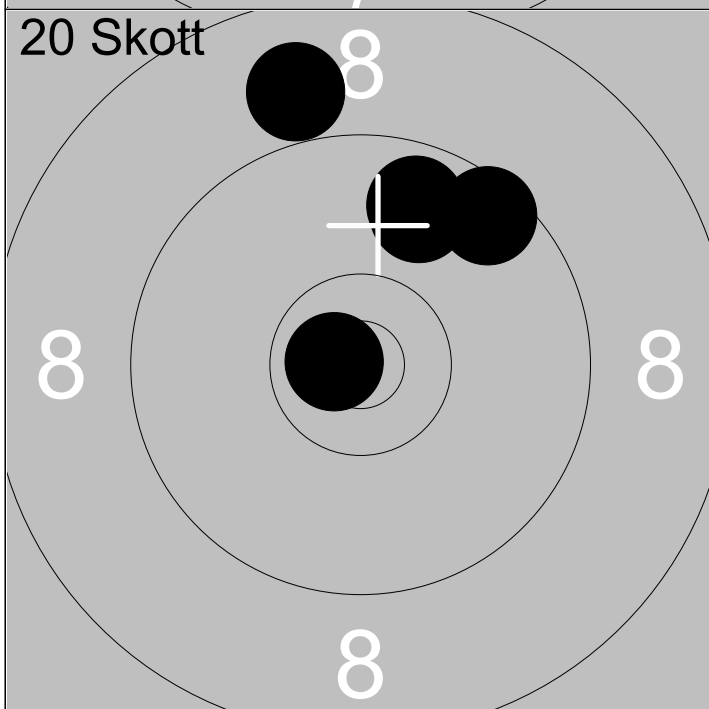

16:	10.8x	←
17:	8.9	↑
18:	9.8	↑
19:	9.5	↗
20:	9.7	↑

Serie	45
Total	184



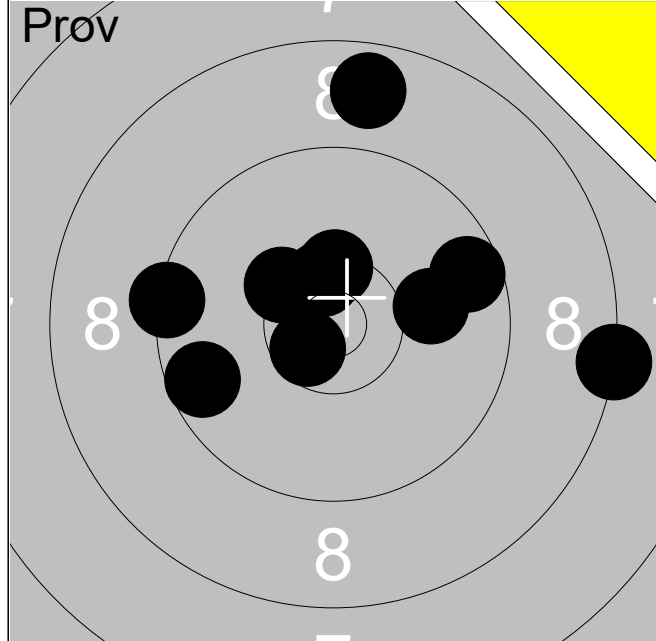

1:	8.7	↑
2:	9.4	←
3:	10.3x	↗
4:	9.6	←
5:	10.0	→
6:	10.6x	↙
7:	10.5x	↑
8:	10.4x	↑
9:	8.3	→
10:	9.6	↗

Serie	<b>93</b>
-------	-----------

Total	<b>0</b>
-------	----------

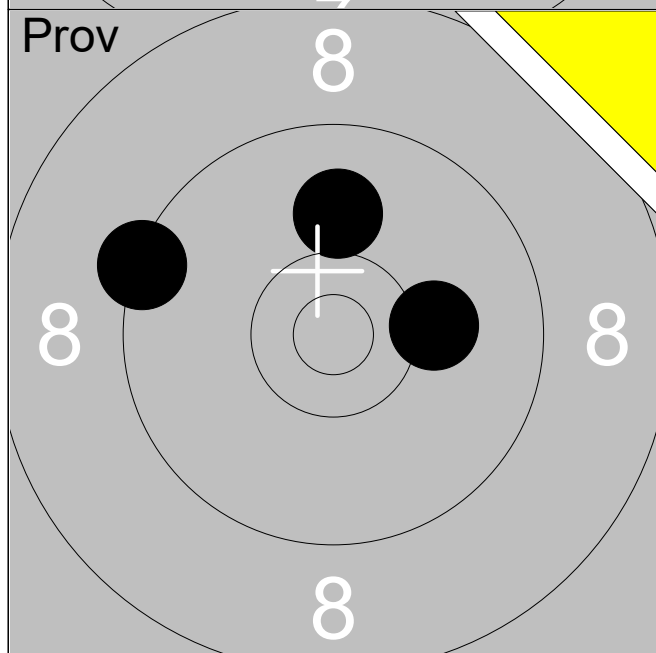

11:	10.2	→
12:	9.4	←
13:	10.0	↑

Serie	<b>29</b>
-------	-----------

Total	<b>0</b>
-------	----------

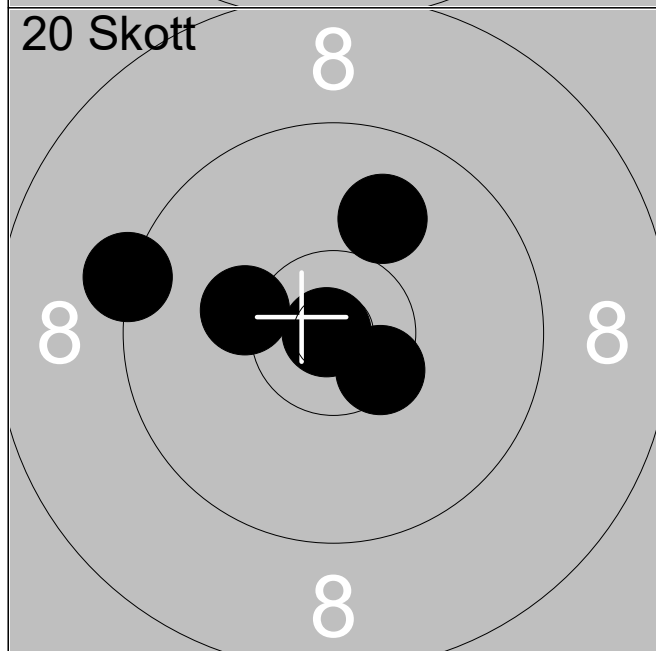

1:	10.9x	←
2:	9.3	←
3:	10.0	↗
4:	10.5x	↘
5:	10.2	←

Serie	<b>49</b>
-------	-----------

Total	<b>49</b>
-------	-----------

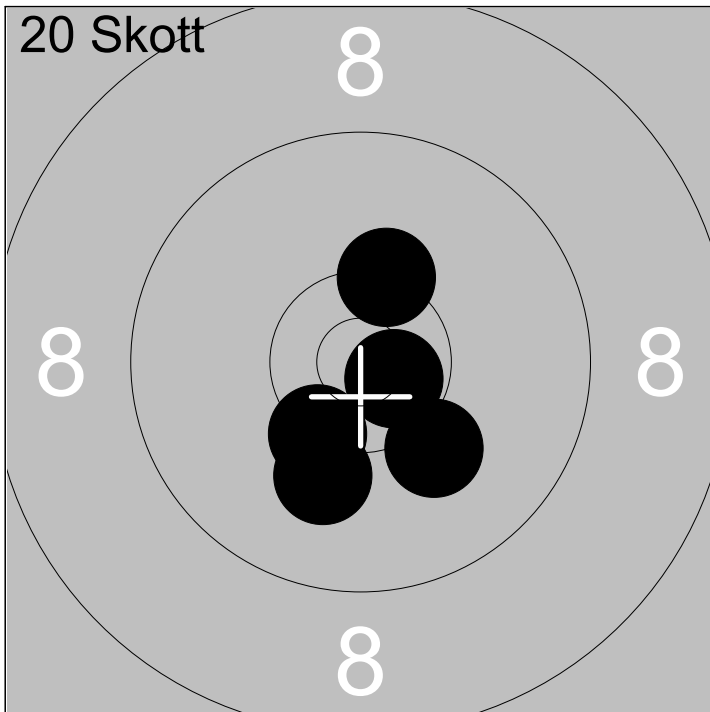

6:	10.7x	↘
7:	10.3x	↗
8:	10.1	↘
9:	10.1	↘
10:	10.3x	↘

Serie 50

Total 99

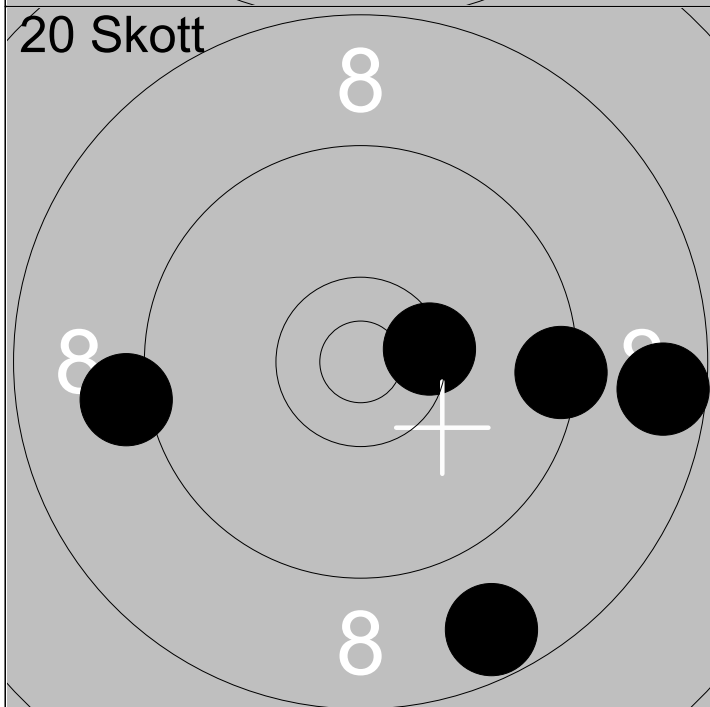

11:	9.1	←
12:	10.4x	→
13:	8.6	→
14:	9.4	→
15:	8.7	↘

Serie 44

Total 143

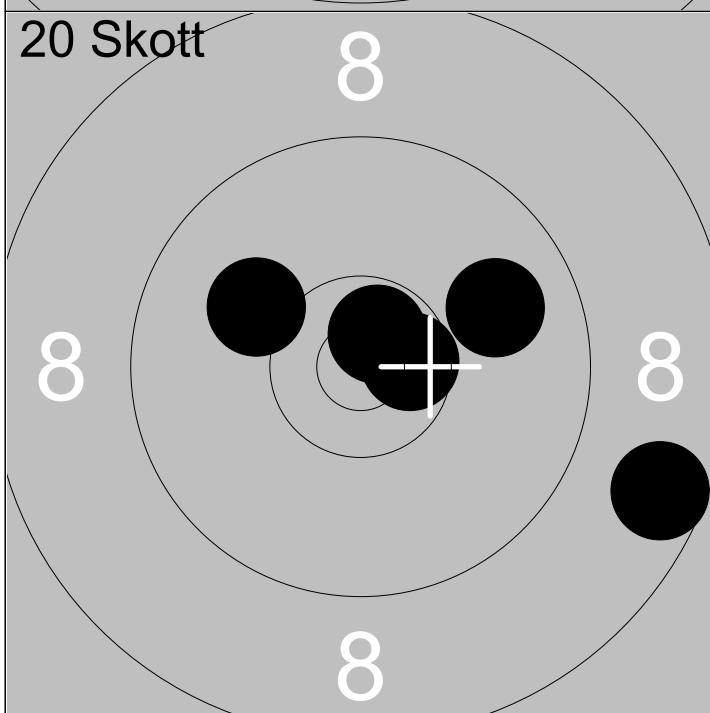

16:	10.1	↖
17:	9.9	↗
18:	10.6x	→
19:	8.6	↘
20:	10.7x	↗

Serie 47

Total 190

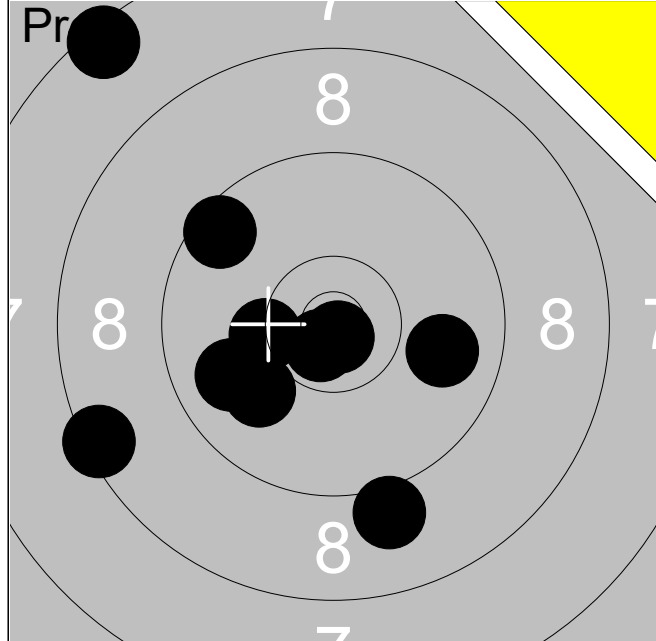

1:	7.5	↗
2:	8.4	↖
3:	10.0	↙
4:	10.3	↖
5:	10.7x	↘
6:	9.9	→
7:	9.1	↘
8:	9.5	↗
9:	9.9	↖
10:	10.8x	↘

Serie	<b>91</b>
-------	-----------

Total	<b>0</b>
-------	----------

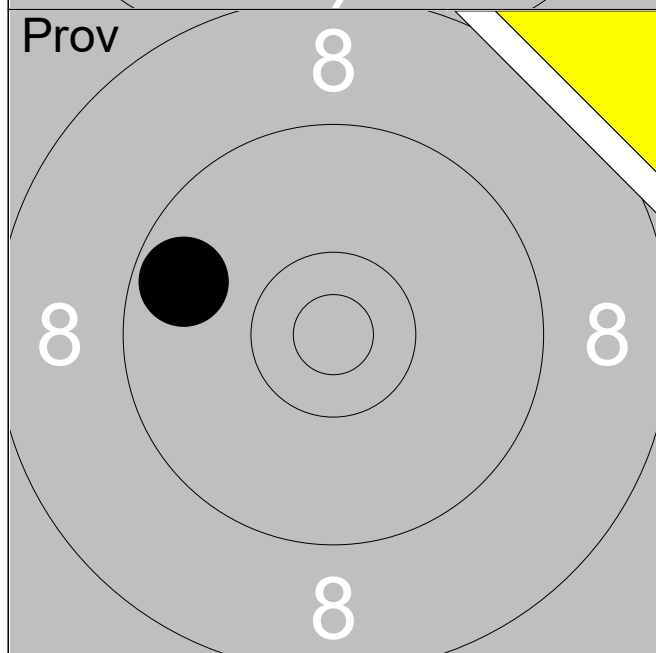

11:	9.7	↖
-----	-----	---

Serie	<b>9</b>
-------	----------

Total	<b>0</b>
-------	----------

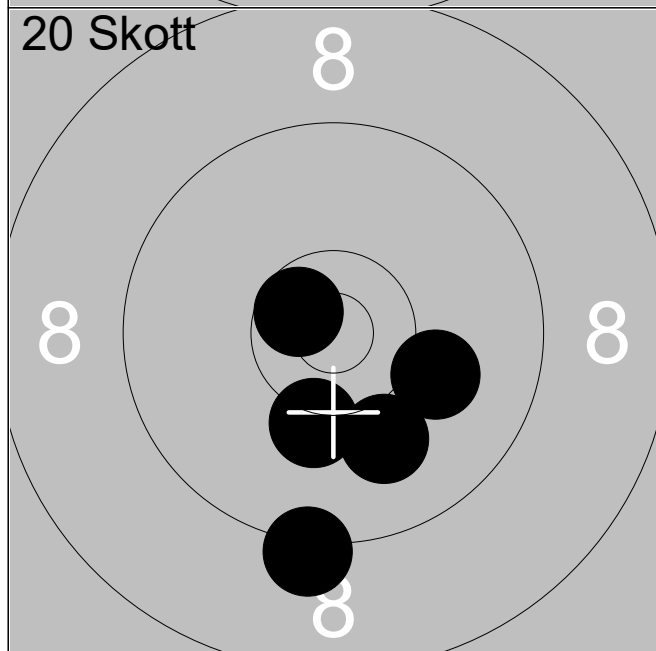

1:	9.2	↘
2:	10.1	↗
3:	10.0	↘
4:	10.6x	↗
5:	10.2	↘

Serie	<b>49</b>
-------	-----------

Total	<b>49</b>
-------	-----------

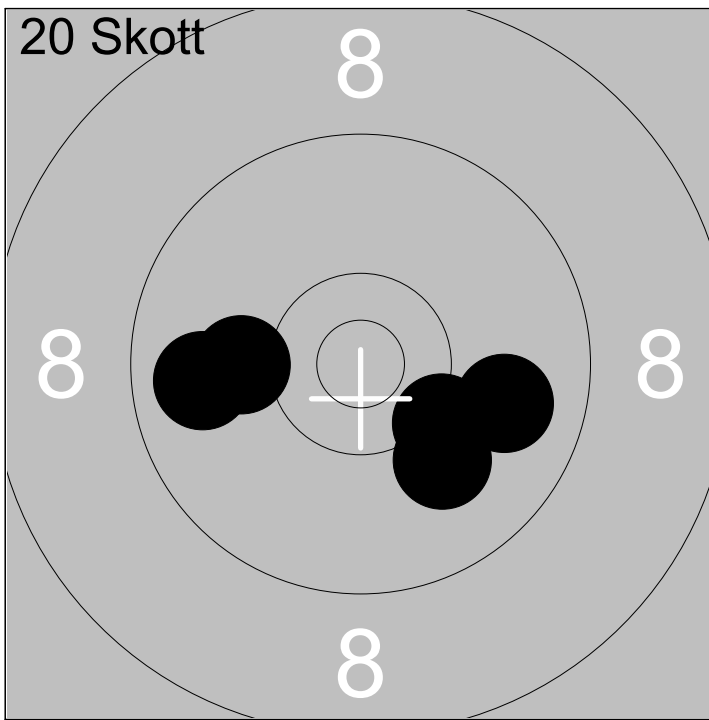

6:	10.1	←
7:	10.2	↘
8:	9.9	→
9:	9.8	←
10:	10.0	↙

Serie	48
Total	97

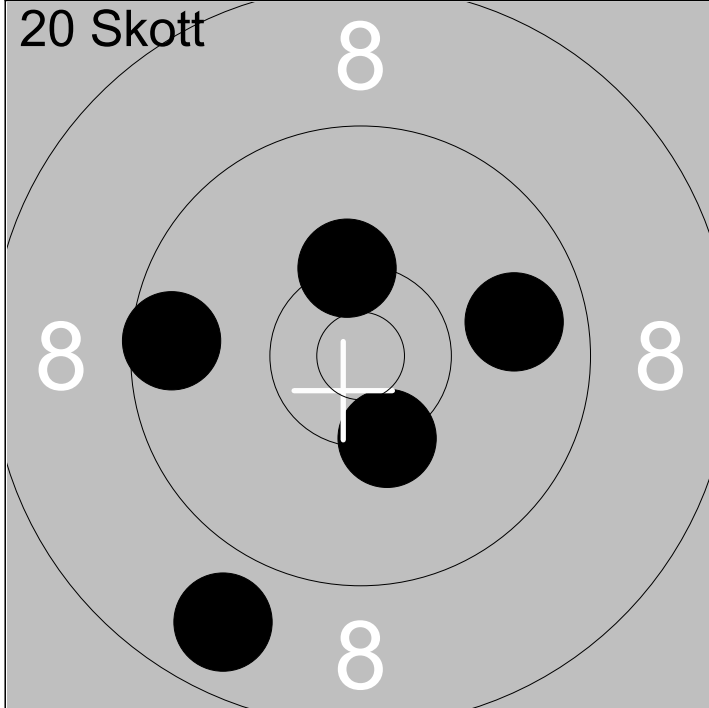

11:	10.3x	↘
12:	9.8	→
13:	10.3x	↑
14:	8.8	↘
15:	9.6	←

Serie	46
Total	143

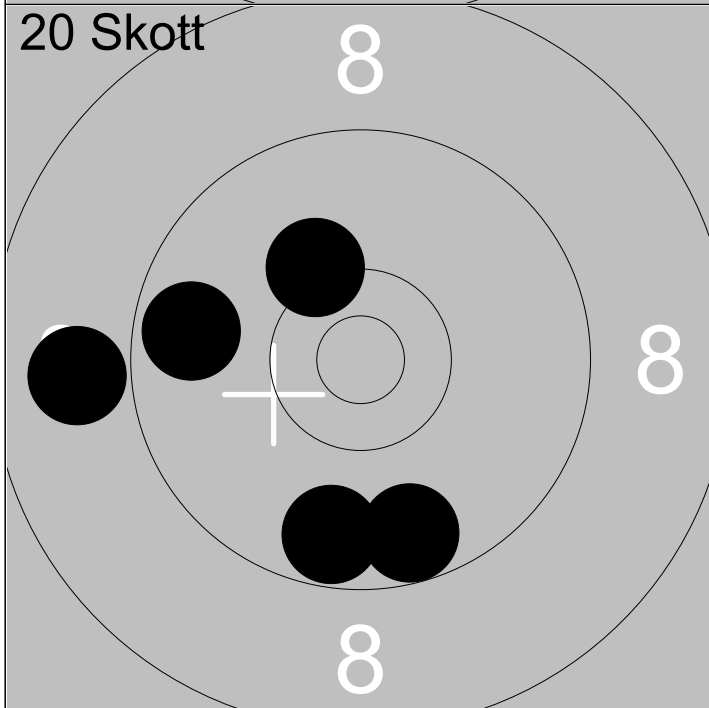

16:	9.7	↘
17:	9.7	↘
18:	9.7	←
19:	8.9	←
20:	10.2	↗

Serie	45
Total	188

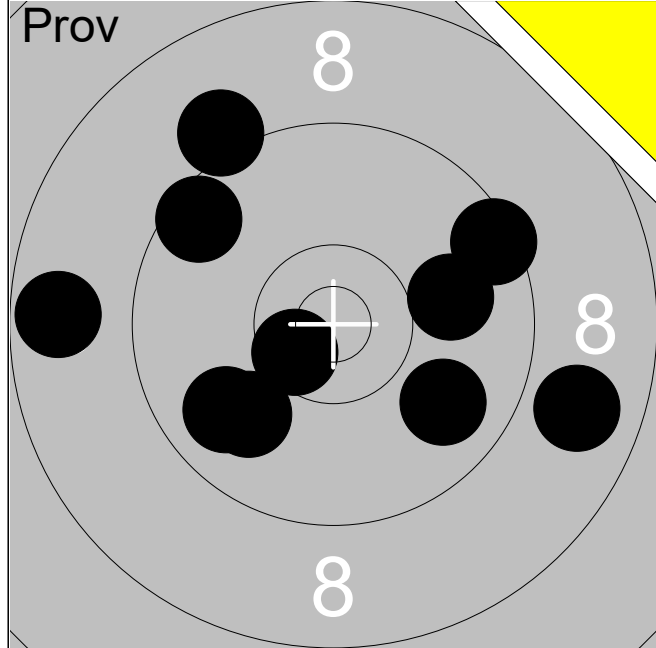

1:	8.7	←
2:	9.6	↗
3:	9.1	↗
4:	10.0	→
5:	9.9	↘
6:	9.8	↙
7:	9.9	↙
8:	8.8	↘
9:	9.5	↗
10:	10.6x	↙

Serie	90
-------	----

Total	0
-------	---

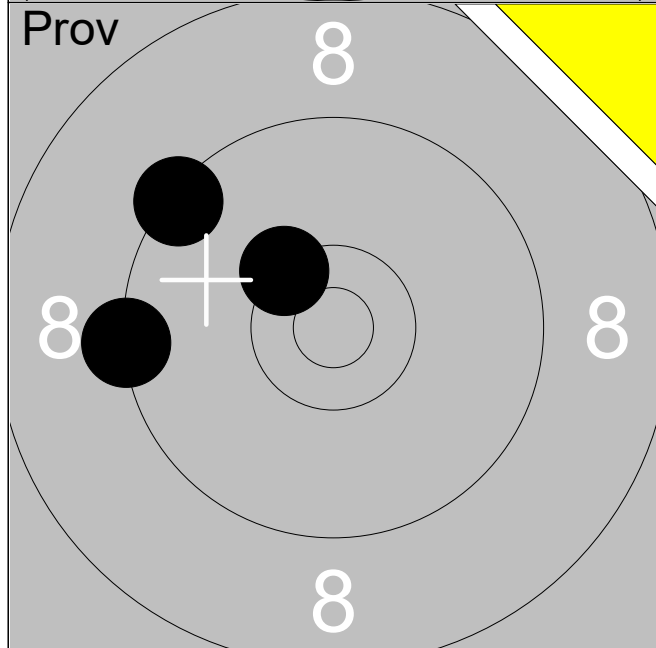

11:	10.4x	↗
12:	9.3	←
13:	9.4	↗

Serie	28
-------	----

Total	0
-------	---

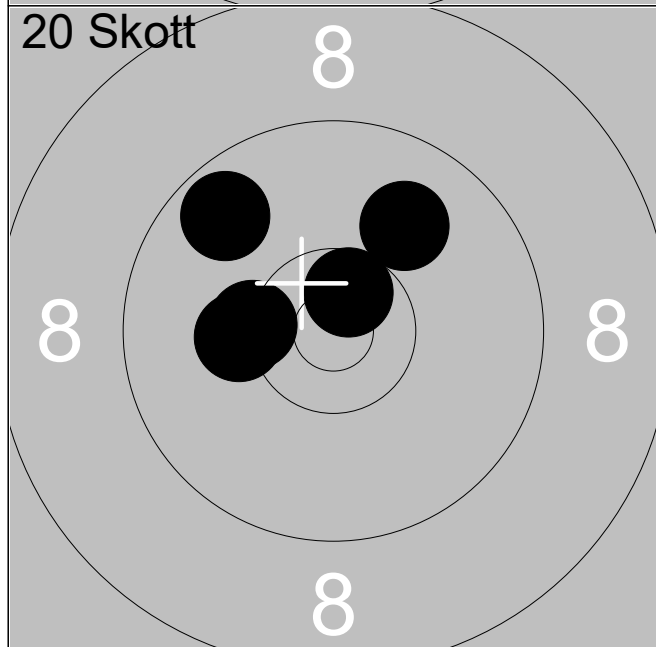

1:	9.7	↗
2:	10.3x	←
3:	10.2	←
4:	10.6x	↗
5:	10.0	↗

Serie	49
-------	----

Total	49
-------	----

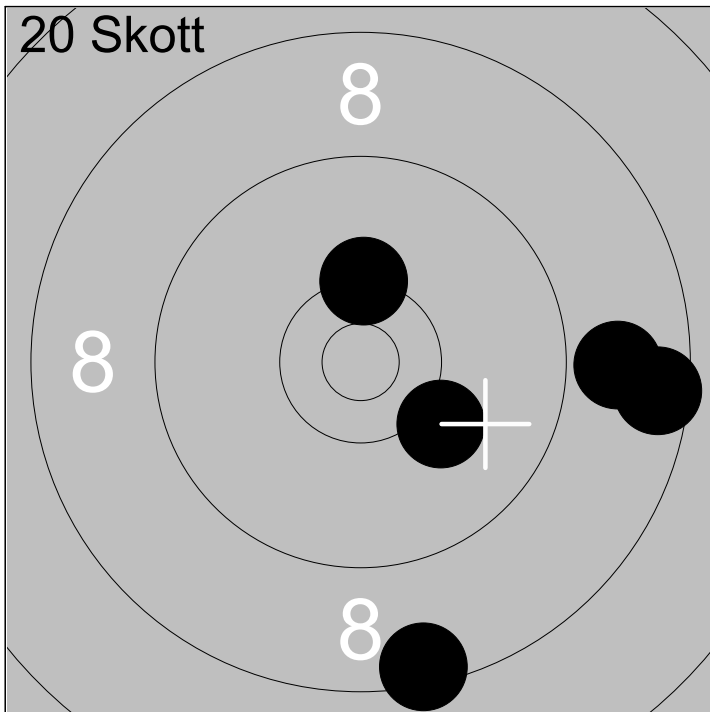

6:	8.4	↓
7:	8.9	→
8:	10.1	↘
9:	10.3x	↑
10:	8.5	→

Serie	44
Total	93

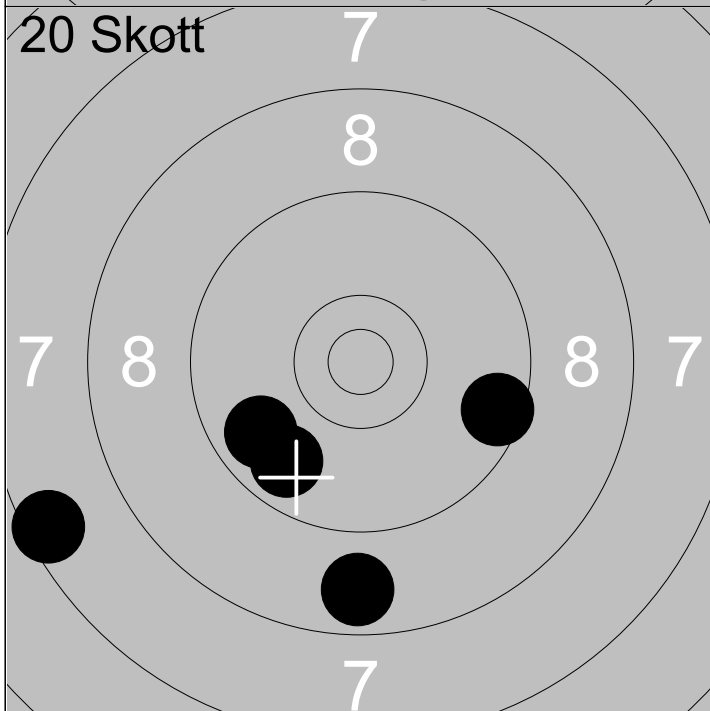

11:	9.7	↙
12:	9.8	↙
13:	8.7	↓
14:	9.5	→
15:	7.5	↙

Serie	42
Total	135

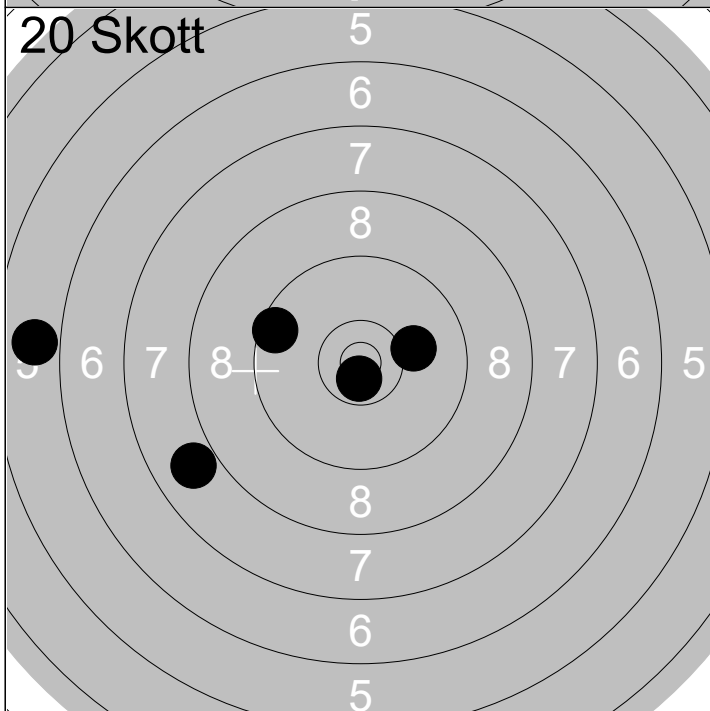

16:	5.9	←
17:	9.5	↙
18:	7.9	↙
19:	10.1	→
20:	10.7x	↓

Serie	41
Total	176

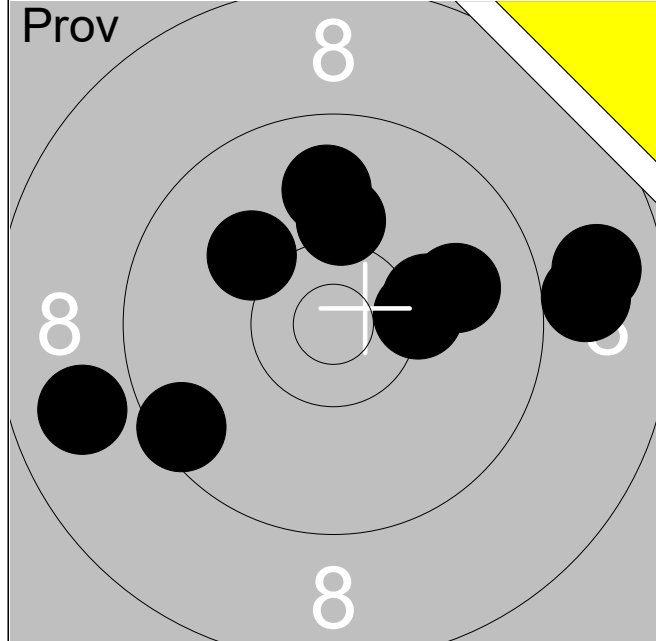

1:	9.5	↙
2:	8.9	↙
3:	10.2	→
4:	8.8	→
5:	10.1	↑
6:	10.3	→
7:	9.0	→
8:	9.9	→
9:	10.1	↗
10:	9.9	↑

Serie	<b>92</b>
-------	-----------

Total	<b>0</b>
-------	----------

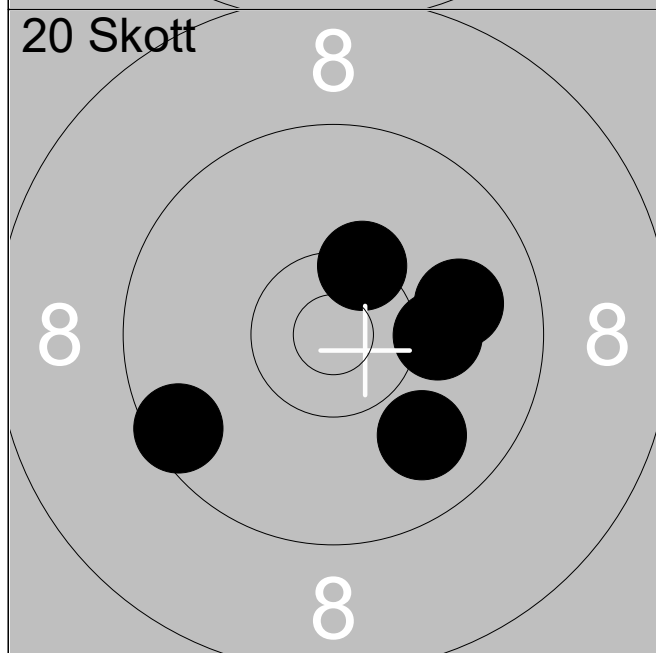

1:	9.5	↙
2:	10.1	→
3:	10.4x	↗
4:	9.9	→
5:	9.9	↘

Serie	<b>47</b>
-------	-----------

Total	<b>47</b>
-------	-----------

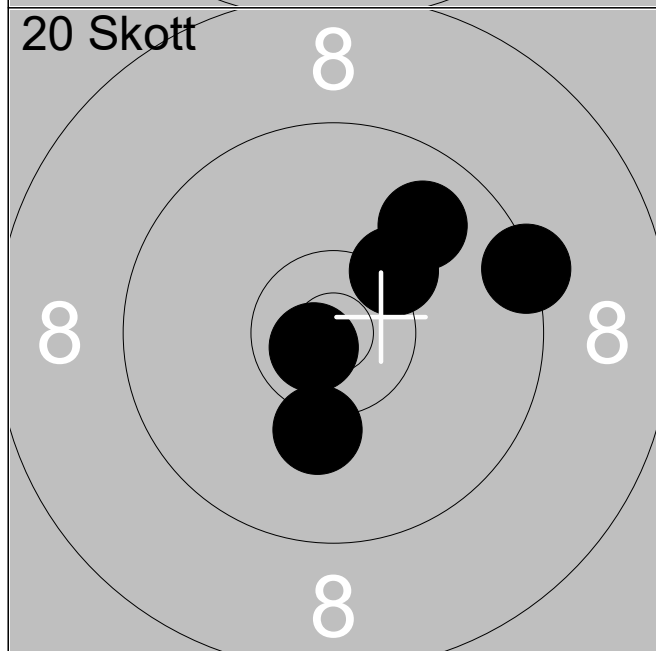

6:	10.3	↗
7:	9.9	↗
8:	9.4	→
9:	10.8x	↙
10:	10.2	↓

Serie	<b>48</b>
-------	-----------

Total	<b>95</b>
-------	-----------

20 Skott

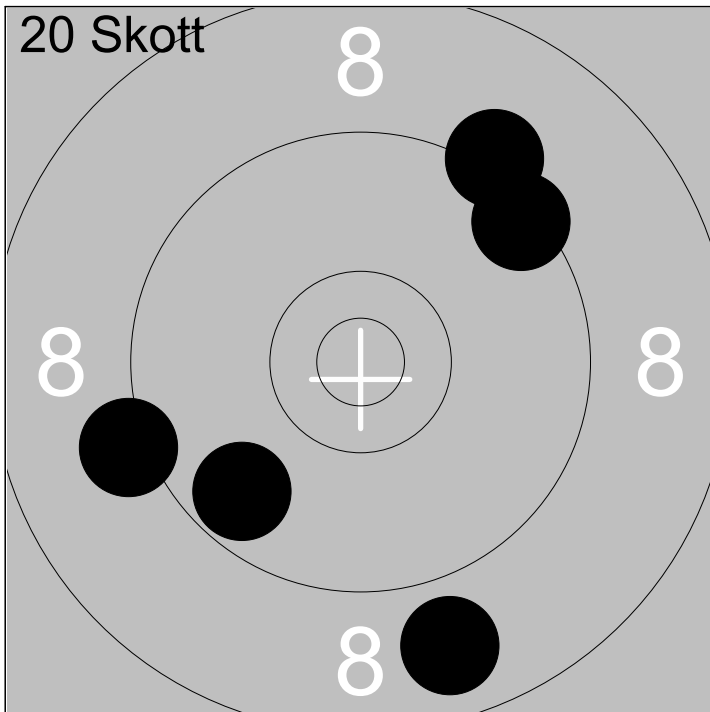

11:	9.2	←
12:	9.7	↙
13:	8.8	↓
14:	9.4	↗
15:	9.2	↗

Serie 44

Total 139

20 Skott

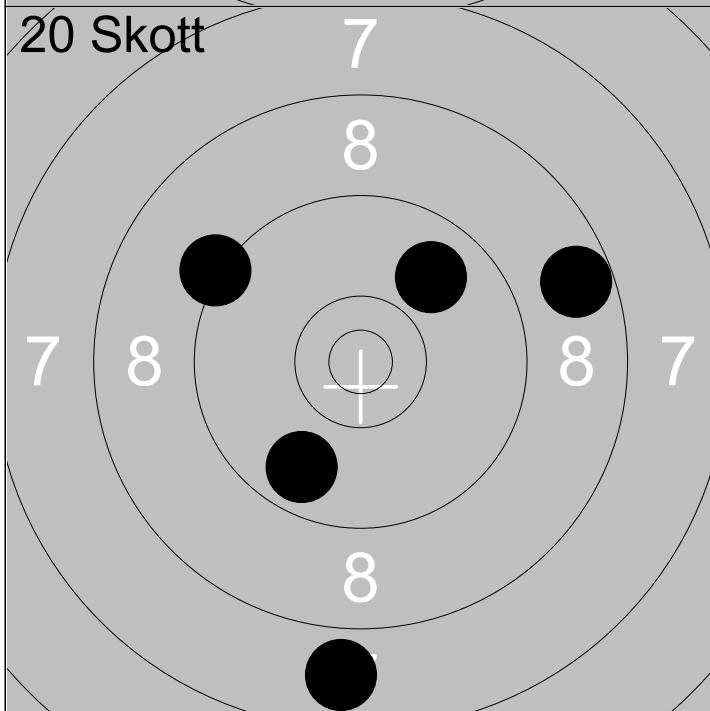

16:	9.2	↖
17:	9.9	↗
18:	8.7	→
19:	9.8	↙
20:	7.8	↓

Serie 42

Total 181



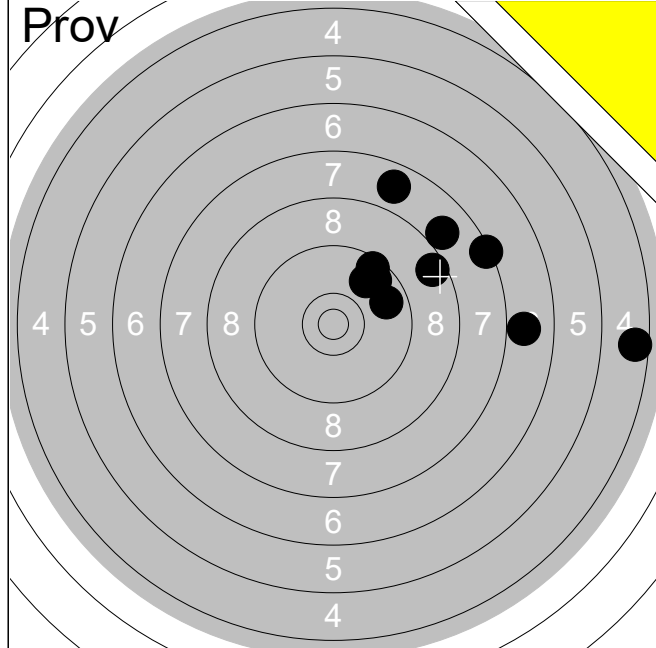

1:	9.8	↗
2:	4.6	→
3:	8.0	↗
4:	7.8	↗
5:	9.7	↗
6:	6.9	→
7:	8.6	↗
8:	7.4	↗
9:	9.7	↗
10:	9.5	↗

Serie	<b>76</b>
-------	-----------

Total	<b>0</b>
-------	----------

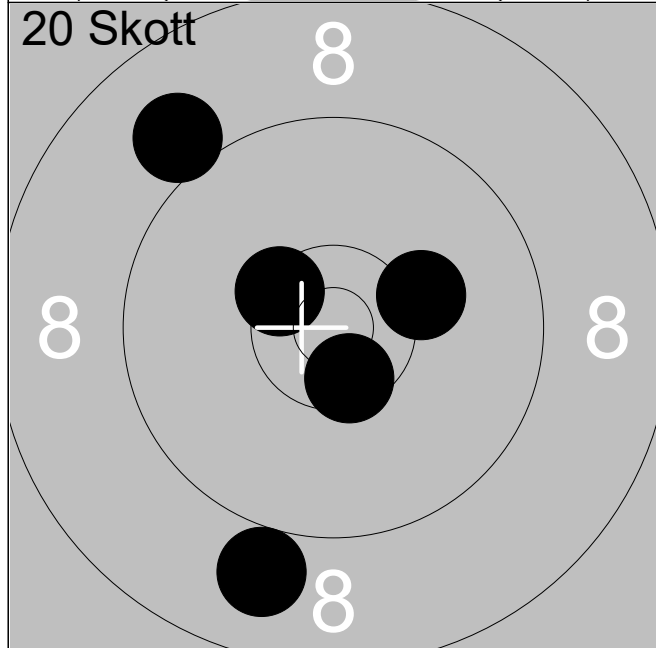

1:	10.2	→
2:	9.0	↗
3:	10.4x	↗
4:	8.9	↓
5:	10.5x	↓

Serie	<b>47</b>
-------	-----------

Total	<b>47</b>
-------	-----------

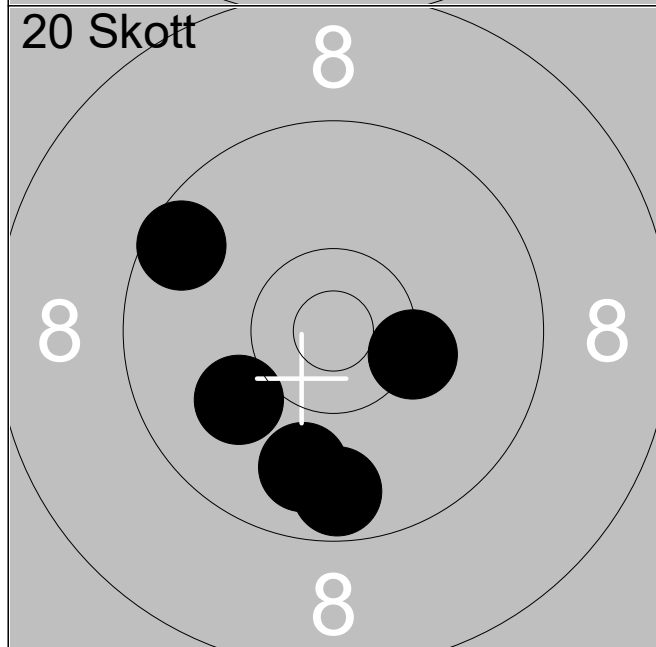

6:	9.6	↖
7:	10.3x	→
8:	10.0	↖
9:	9.7	↓
10:	9.9	↓

Serie	<b>47</b>
-------	-----------

Total	<b>94</b>
-------	-----------

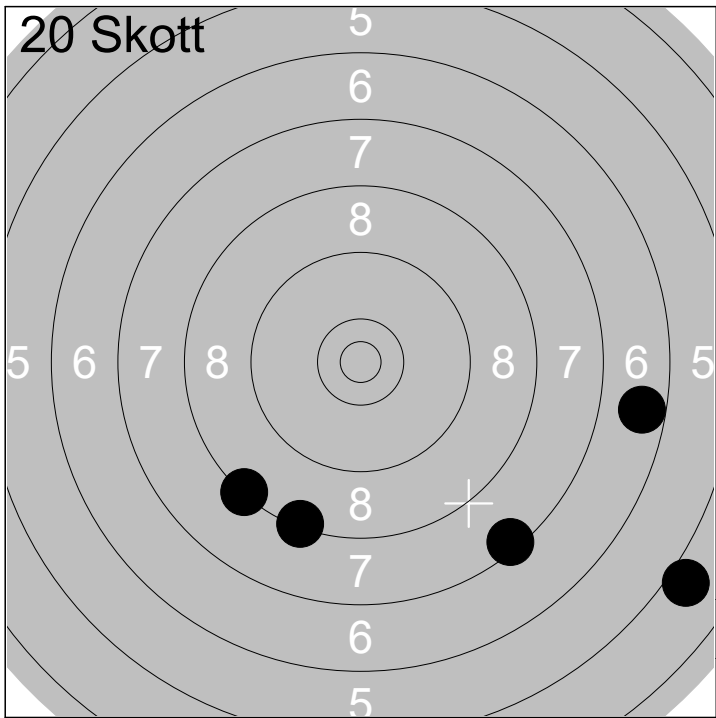

11:	6.7	→
12:	8.3	↓
13:	5.0	↘
14:	7.4	↘
15:	8.3	↙

Serie	34
Total	128

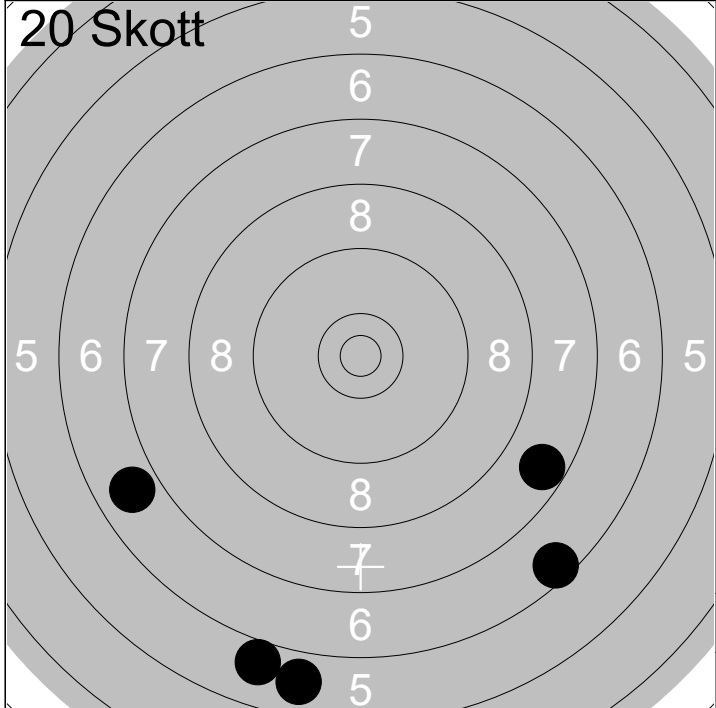

16:	6.9	↙
17:	5.8	↓
18:	7.7	↘
19:	6.0	↓
20:	6.5	↘

Serie	30
Total	158

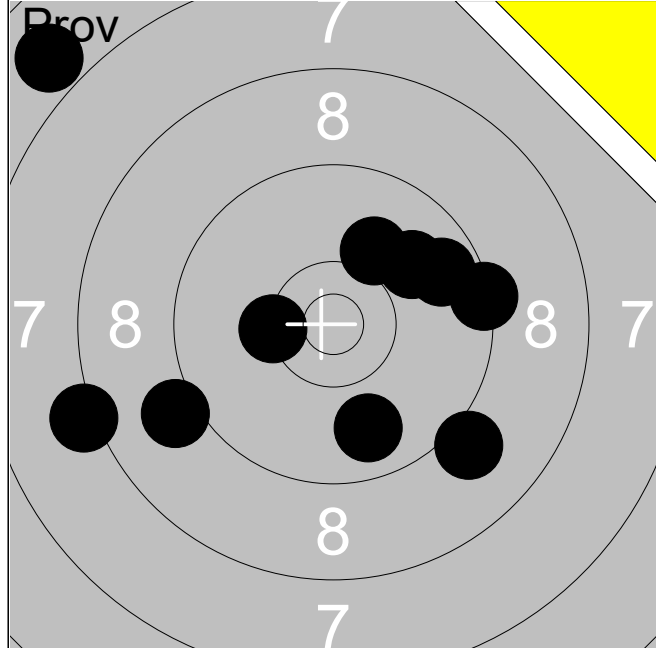

1:	6.9	↗
2:	8.2	←
3:	9.1	↘
4:	9.8	↓
5:	9.7	↗
6:	9.4	→
7:	10.1	↗
8:	9.1	←
9:	9.9	↗
10:	10.3x	←

Serie	<b>88</b>
-------	-----------

Total	<b>0</b>
-------	----------

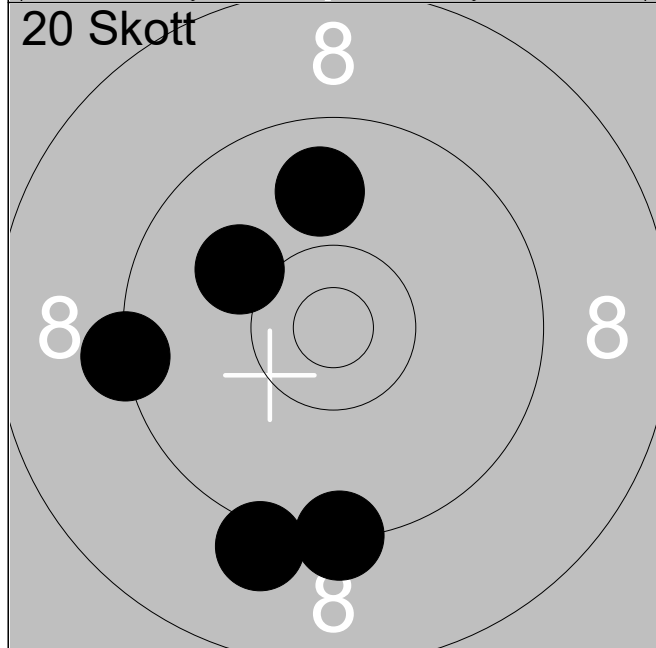

1:	9.9	↑
2:	9.3	←
3:	10.1	↖
4:	9.1	↓
5:	9.3	↓

Serie	<b>46</b>
-------	-----------

Total	<b>46</b>
-------	-----------

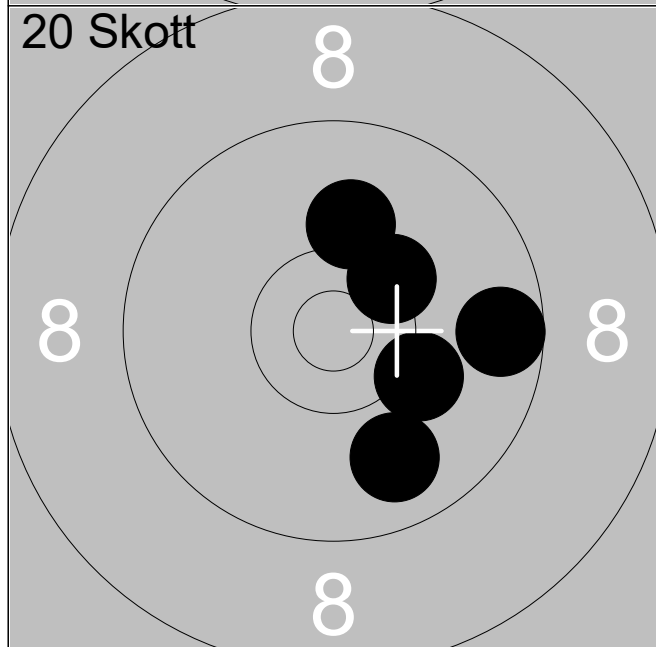

6:	10.1	↑
7:	9.6	→
8:	10.3x	↗
9:	9.8	↓
10:	10.2	↘

Serie	<b>48</b>
-------	-----------

Total	<b>94</b>
-------	-----------

20 Skott

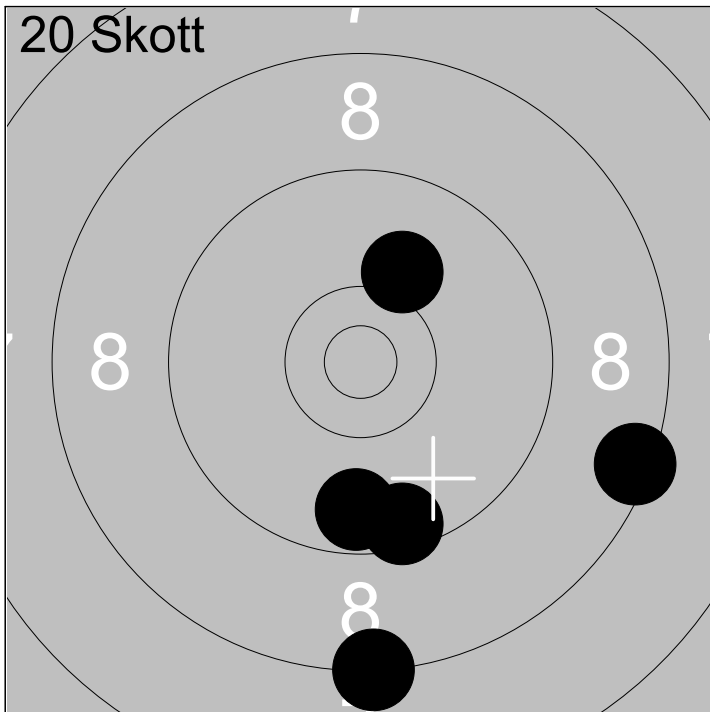

11:	8.3	↓
12:	9.7	↓
13:	9.5	↓
14:	10.1	↗
15:	8.4	↘

Serie 44

Total 138

20 Skott

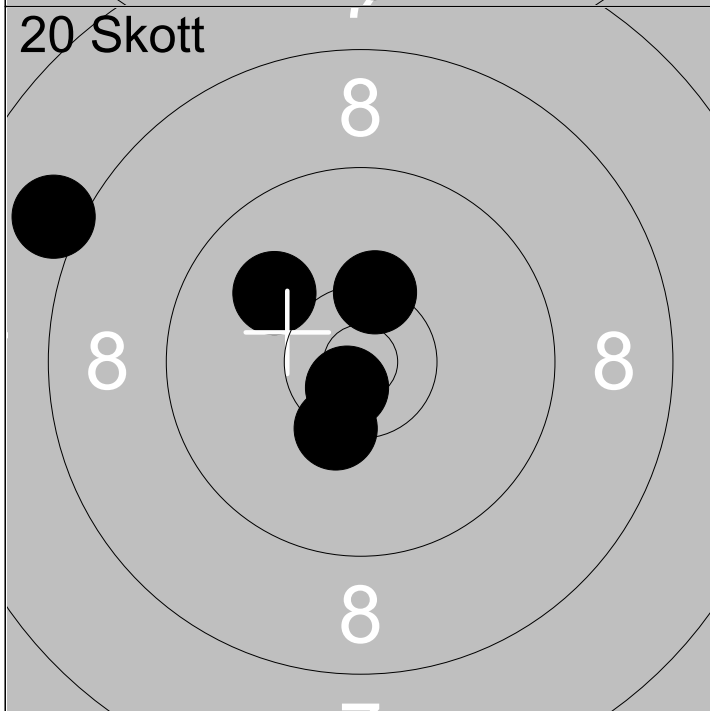

16:	10.0	↖
17:	10.3x	↓
18:	10.3x	↑
19:	8.1	↖
20:	10.7x	↓

Serie 48

Total 186

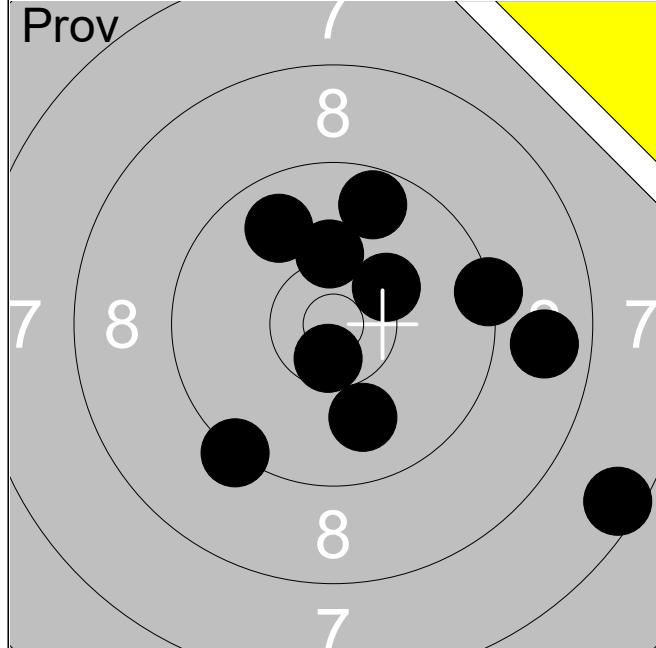

1:	7.5	↘
2:	9.8	↗
3:	10.6x	↓
4:	10.3x	↗
5:	10.0	↓
6:	9.7	↗
7:	9.3	→
8:	8.8	→
9:	10.2	↑
10:	9.3	↙

Serie	91
-------	----

Total	0
-------	---

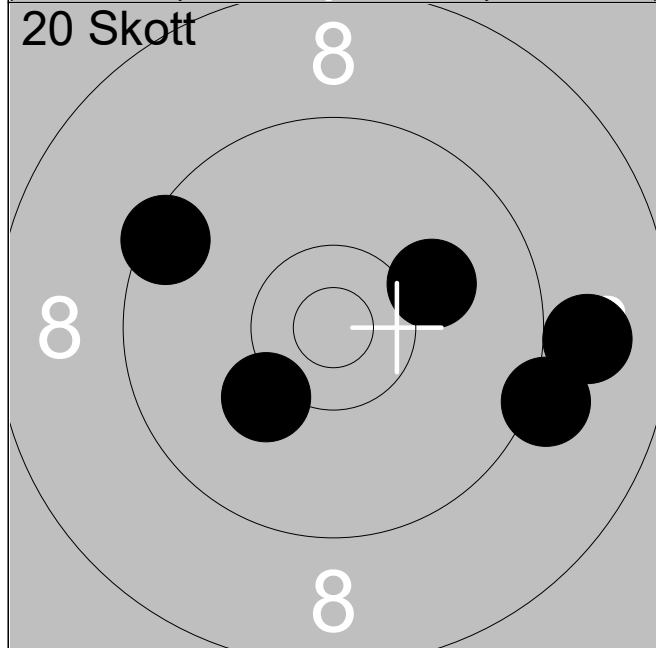

1:	10.2	↙
2:	9.5	↖
3:	10.1	↗
4:	9.2	↘
5:	9.0	→

Serie	47
-------	----

Total	47
-------	----

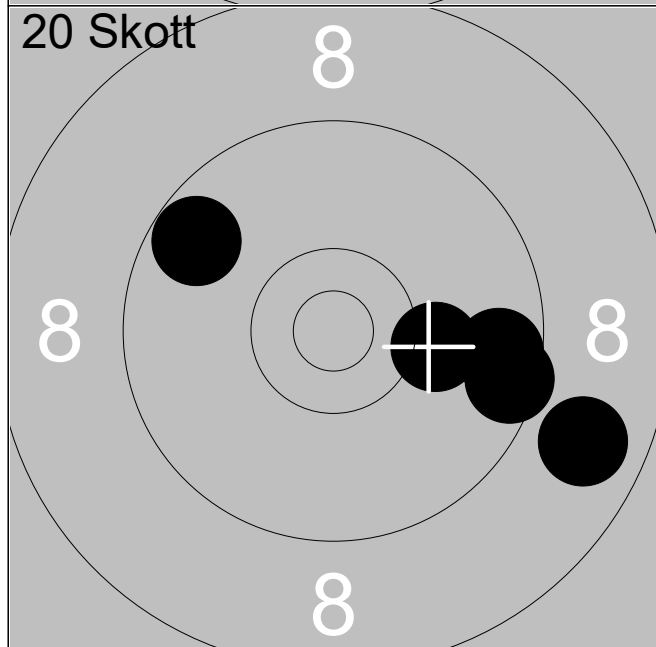

6:	10.1	→
7:	8.8	↘
8:	9.5	→
9:	9.7	↗
10:	9.6	→

Serie	45
-------	----

Total	92
-------	----

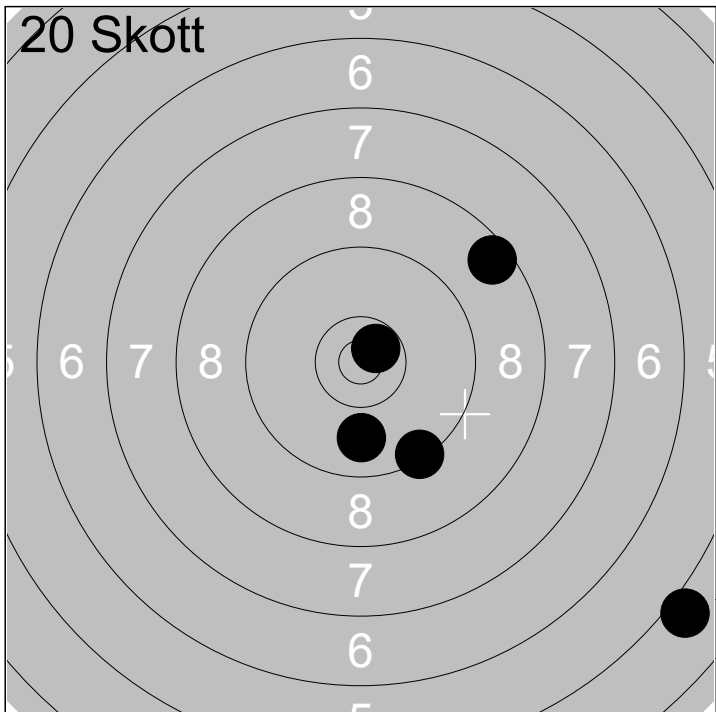

11:	8.6	↗
12:	5.1	↘
13:	9.9	↓
14:	9.4	↘
15:	10.7x	↗

Serie	41
Total	133

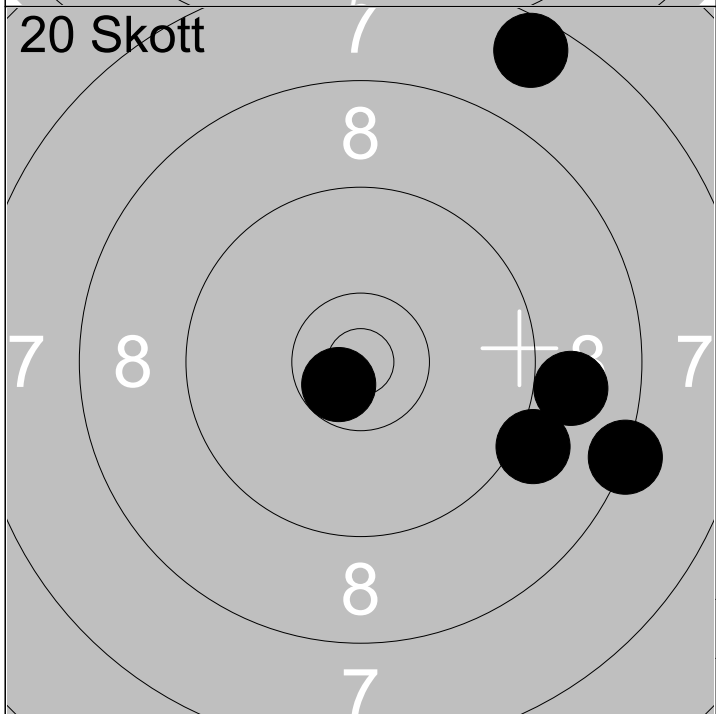

16:	7.6	↑
17:	9.1	↘
18:	8.3	↘
19:	10.7x	↙
20:	9.0	→

Serie	43
Total	176

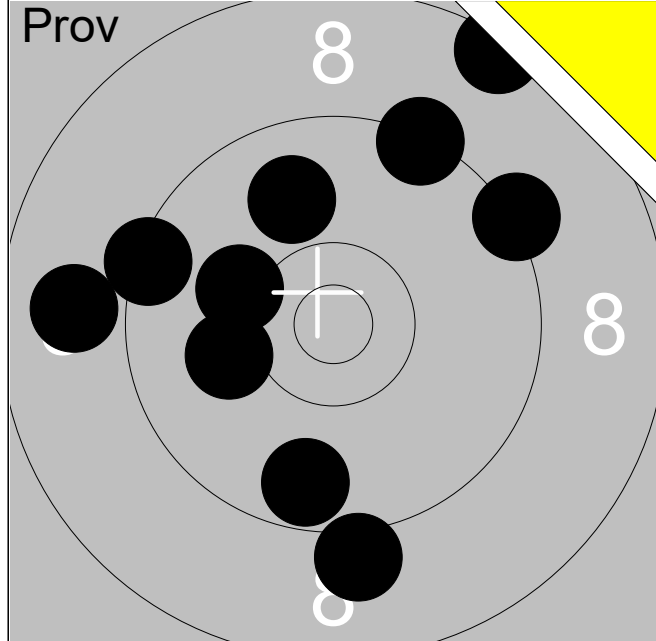

1:	8.4	↗
2:	10.1	←
3:	8.9	←
4:	9.4	←
5:	9.1	↓
6:	9.7	↓
7:	10.2	←
8:	9.9	↑
9:	9.3	↗
10:	9.3	↘

Serie	<b>90</b>
-------	-----------

Total	<b>0</b>
-------	----------

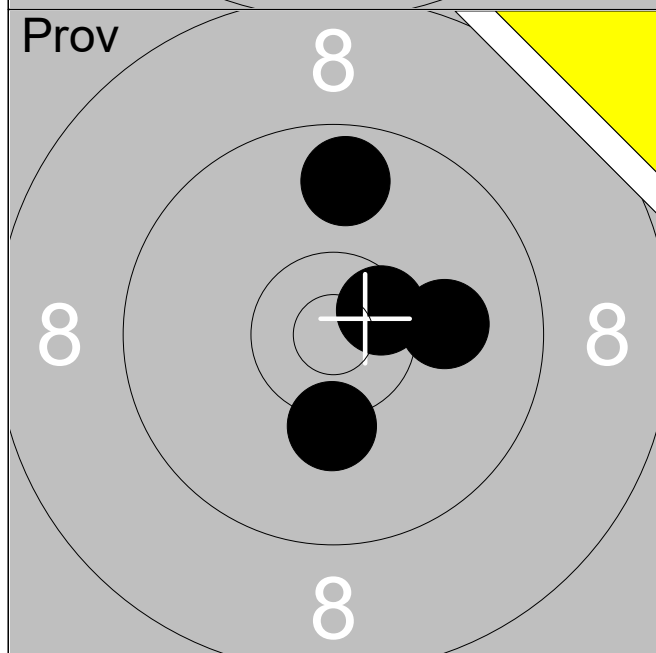

11:	10.1	→
12:	9.7	↑
13:	10.2	↓
14:	10.5x	↘

Serie	<b>39</b>
-------	-----------

Total	<b>0</b>
-------	----------

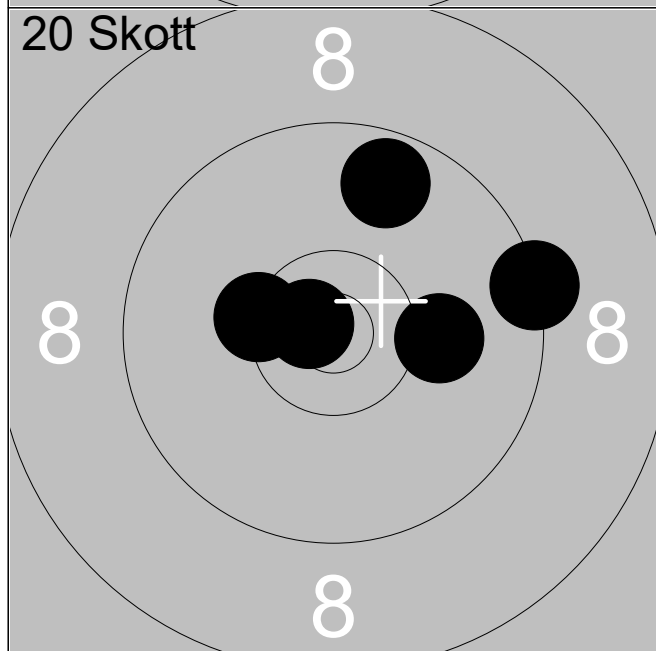

1:	10.7x	←
2:	10.3x	←
3:	9.3	→
4:	9.7	↑
5:	10.1	→

Serie	<b>48</b>
-------	-----------

Total	<b>48</b>
-------	-----------

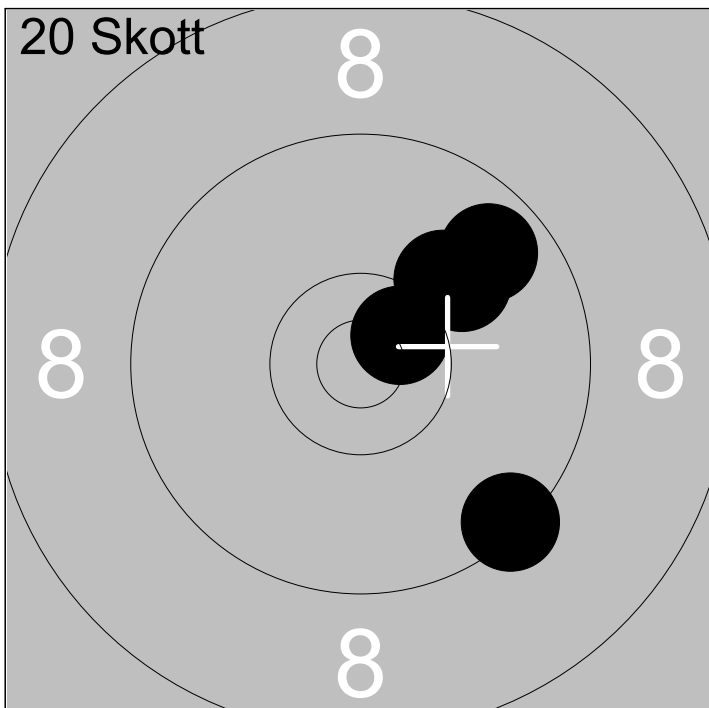

6:	9.7	↗
7:	9.4	↘
8:	10.6x	↗
9:	10.0	↗
10:	10.1	↗

Serie	48
Total	96

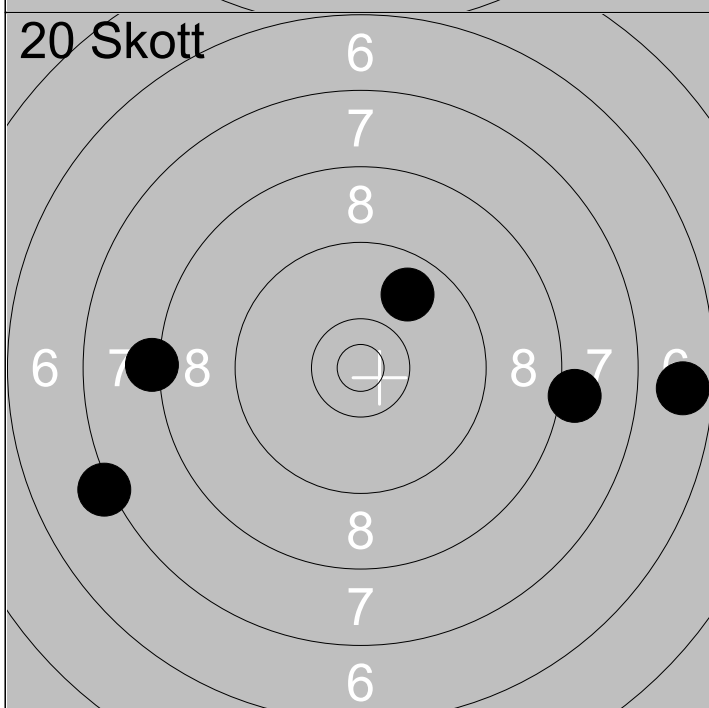

11:	7.2	↙
12:	6.7	→
13:	8.2	↙
14:	8.1	→
15:	9.8	↗

Serie	38
Total	134

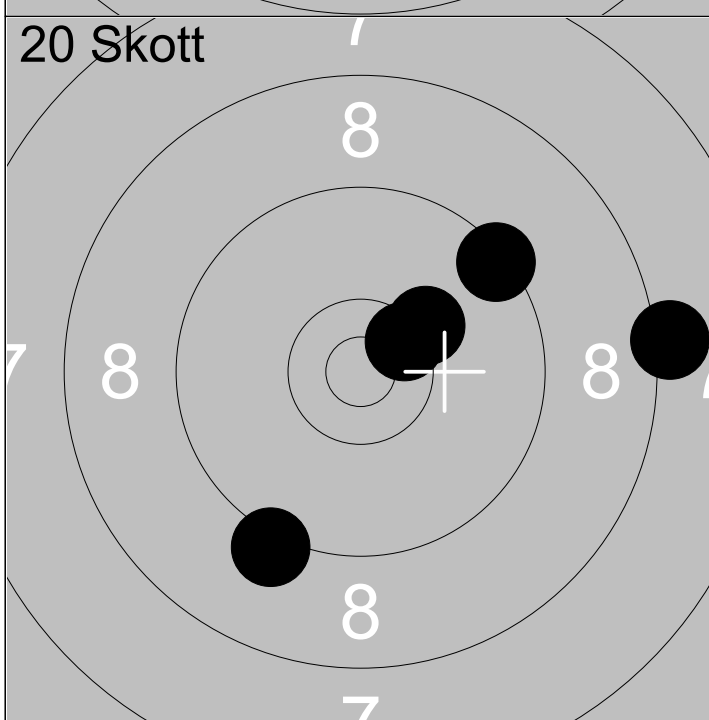

16:	9.4	↗
17:	9.2	↘
18:	10.2	↗
19:	8.2	→
20:	10.5x	↗

Serie	46
Total	180



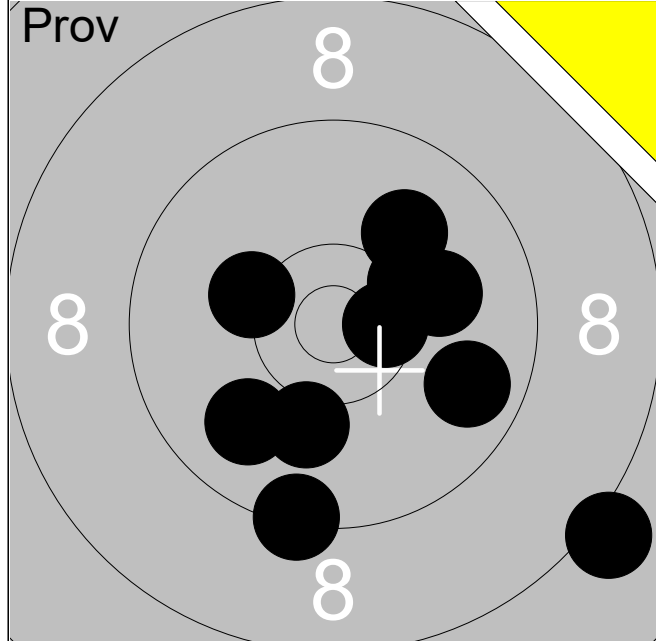

1:	8.1	↘
2:	9.8	↘
3:	10.2	↗
4:	10.5x	→
5:	10.1	↓
6:	10.2	←
7:	9.9	↘
8:	10.1	→
9:	10.0	↗
10:	9.4	↓
<b>Serie</b>		<b>95</b>
<b>Total</b>		<b>0</b>

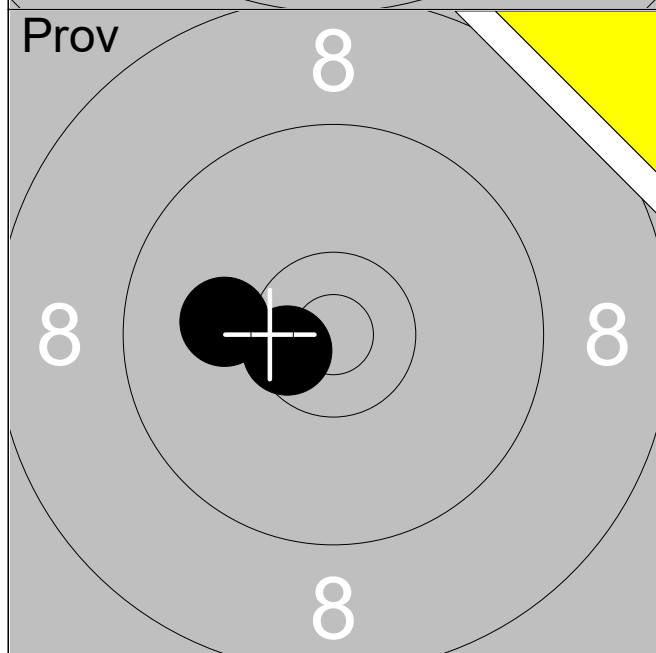

11:	10.6x	←
12:	10.1	←
<b>Serie</b>		<b>20</b>
<b>Total</b>		<b>0</b>

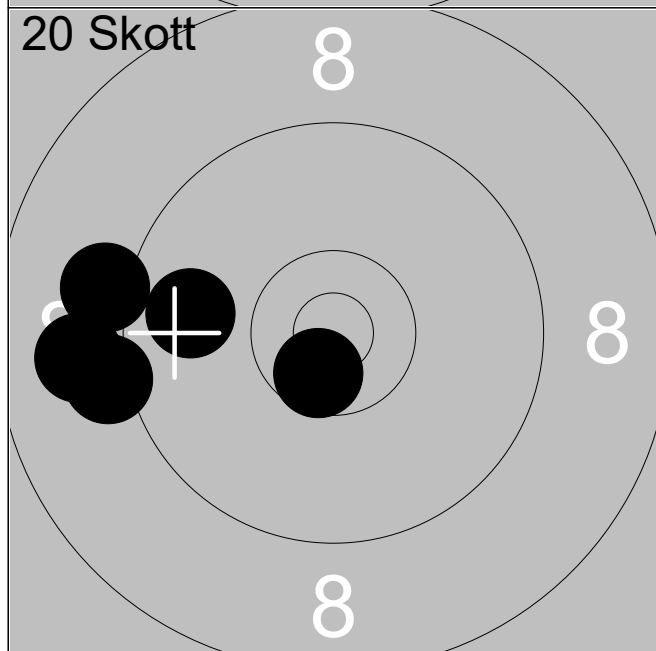

1:	8.9	←
2:	9.1	←
3:	10.6x	↓
4:	9.1	←
5:	9.8	←
<b>Serie</b>		<b>45</b>
<b>Total</b>		<b>45</b>

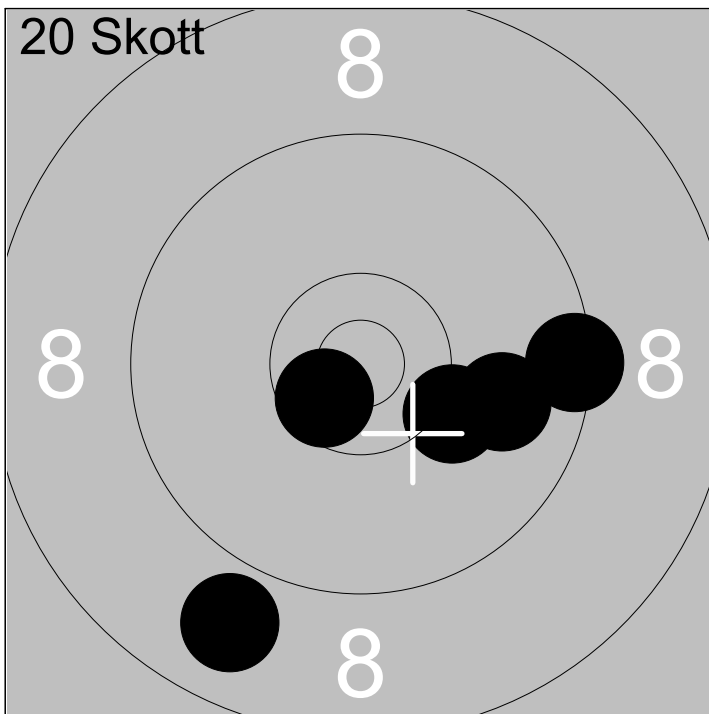

6:	9.4	→
7:	8.9	↘
8:	9.9	→
9:	10.6x	↙
10:	10.2	↘

Serie	46
Total	91

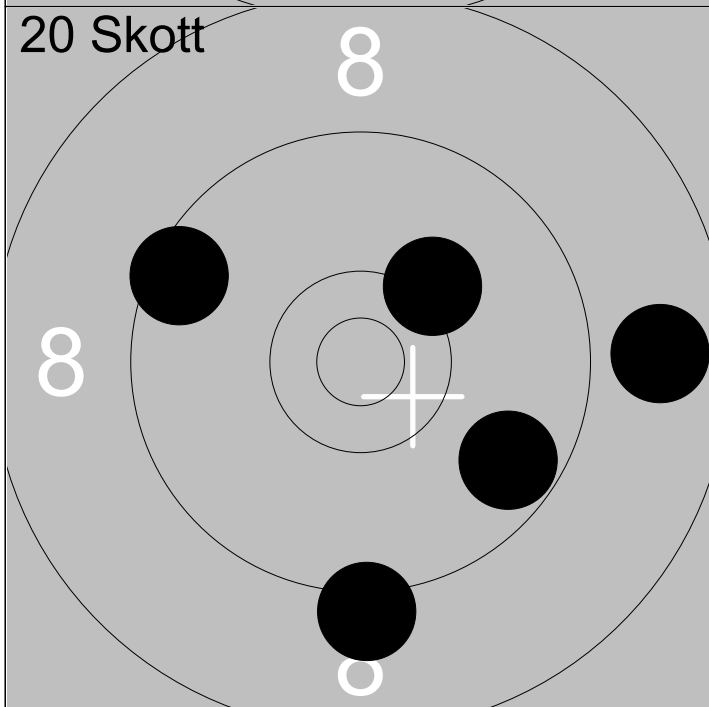

11:	9.5	↖
12:	9.7	↘
13:	8.8	→
14:	9.2	↓
15:	10.2	↗

Serie	45
Total	136

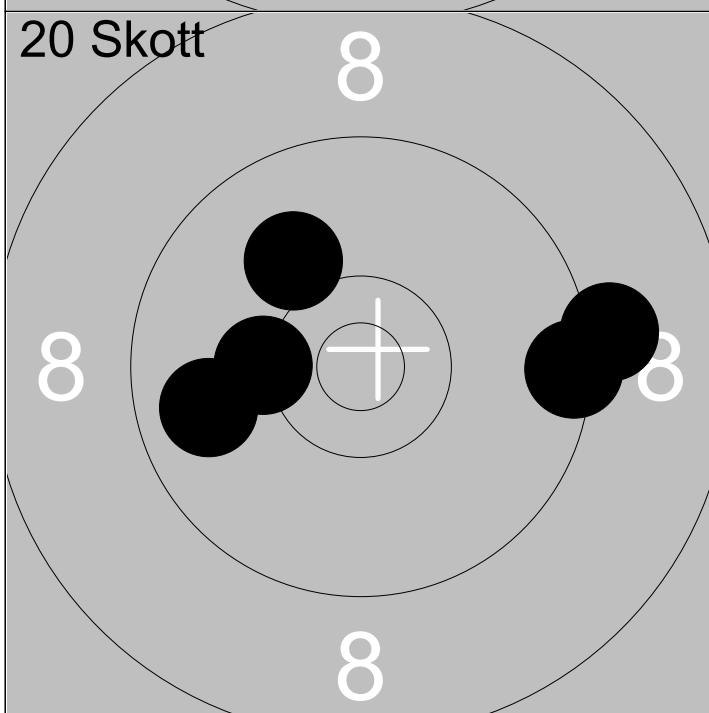

16:	9.2	→
17:	10.0	↗
18:	10.2	←
19:	9.4	→
20:	9.8	←

Serie	47
Total	183

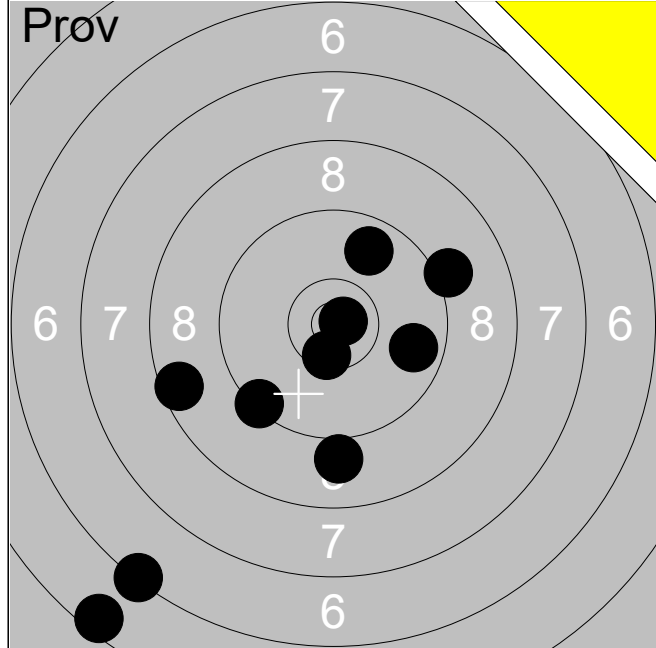

1:	6.3	↙
2:	5.5	↙
3:	8.5	←
4:	9.0	↓
5:	10.5x	↓
6:	9.4	↙
7:	9.1	→
8:	9.7	→
9:	10.8x	→
10:	9.8	↑

Serie	<b>84</b>
-------	-----------

Total	<b>0</b>
-------	----------

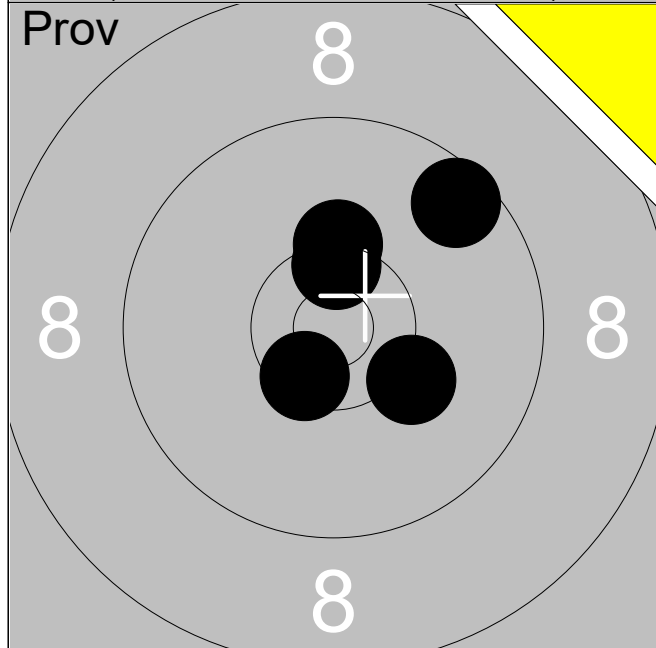

11:	10.2	↘
12:	10.3x	↑
13:	9.6	↗
14:	10.5x	↙
15:	10.5x	↑

Serie	<b>49</b>
-------	-----------

Total	<b>0</b>
-------	----------

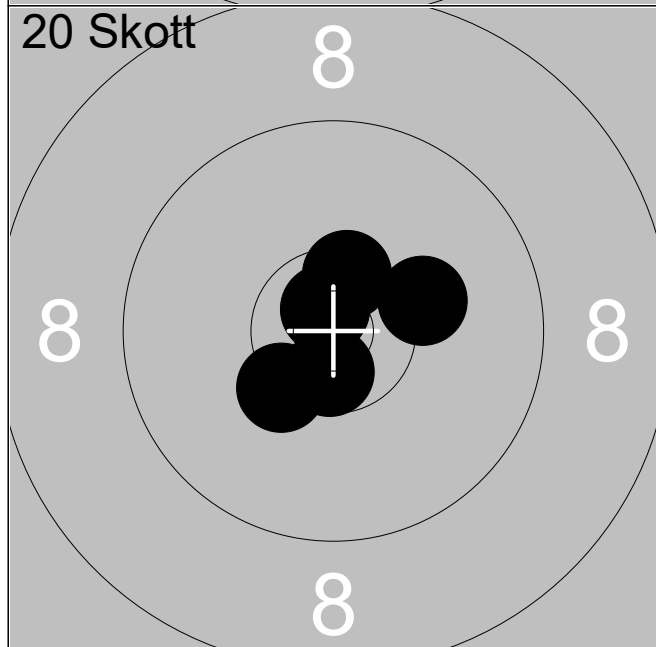

1:	10.2	→
2:	10.5x	↑
3:	10.6x	↓
4:	10.8x	↑
5:	10.3x	↙

Serie	<b>50</b>
-------	-----------

Total	<b>50</b>
-------	-----------

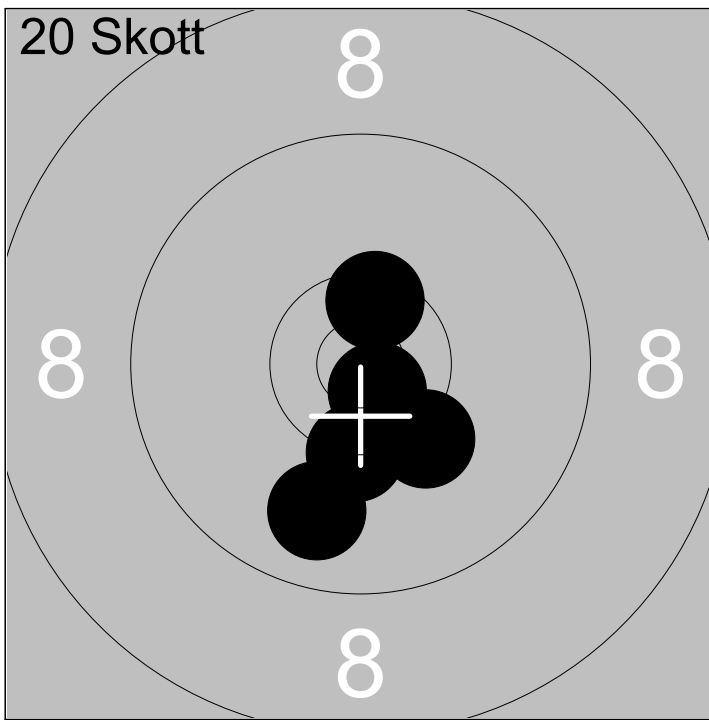

6:	10.5x	↑
7:	10.3x	↓
8:	10.2	↘
9:	9.8	↘
10:	10.7x	↘

Serie	49
Total	99

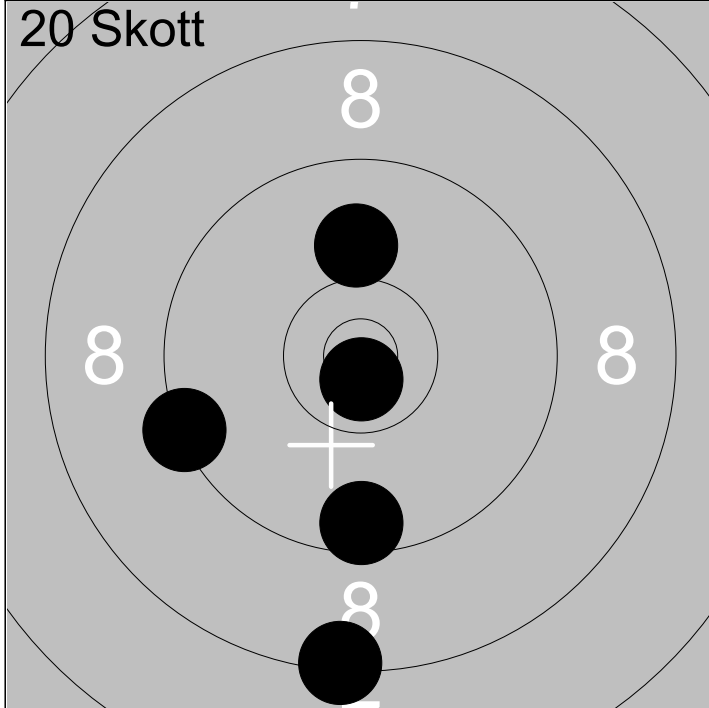

11:	8.4	↓
12:	10.8x	↓
13:	9.5	↓
14:	9.3	↙
15:	10.0	↑

Serie	46
Total	145

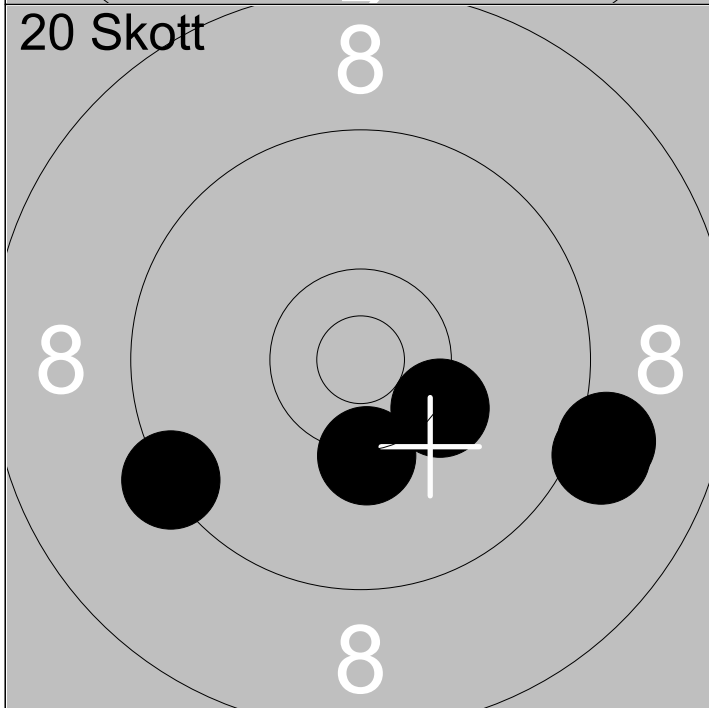

16:	9.3	↙
17:	9.1	↘
18:	10.3	↓
19:	10.3	↘
20:	9.1	↘

Serie	47
Total	192

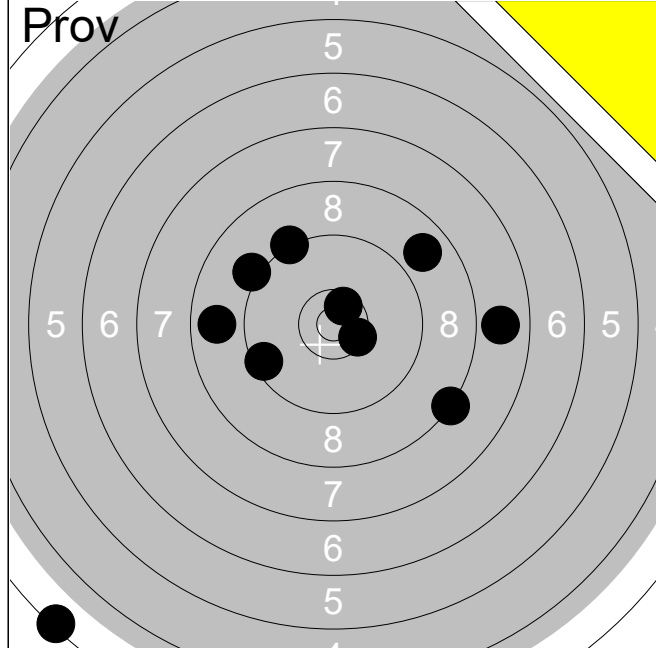

1:	3.4	↙
2:	9.2	↗
3:	9.3	↗
4:	8.8	←
5:	10.4x	↘
6:	9.5	↙
7:	7.9	→
8:	8.3	↘
9:	8.8	↗
10:	10.6x	↗

Serie	<b>81</b>
-------	-----------

Total	<b>0</b>
-------	----------

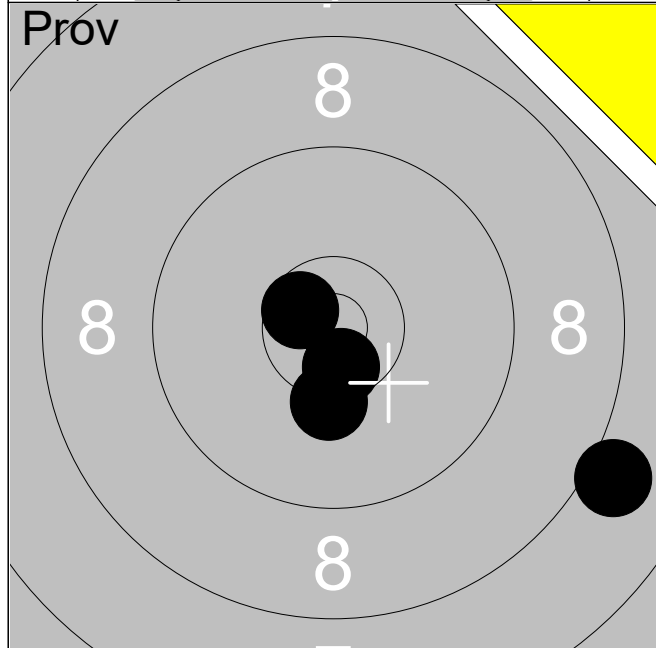

11:	8.1	↘
12:	10.6x	↖
13:	10.3	↓
14:	10.6x	↓

Serie	<b>38</b>
-------	-----------

Total	<b>0</b>
-------	----------

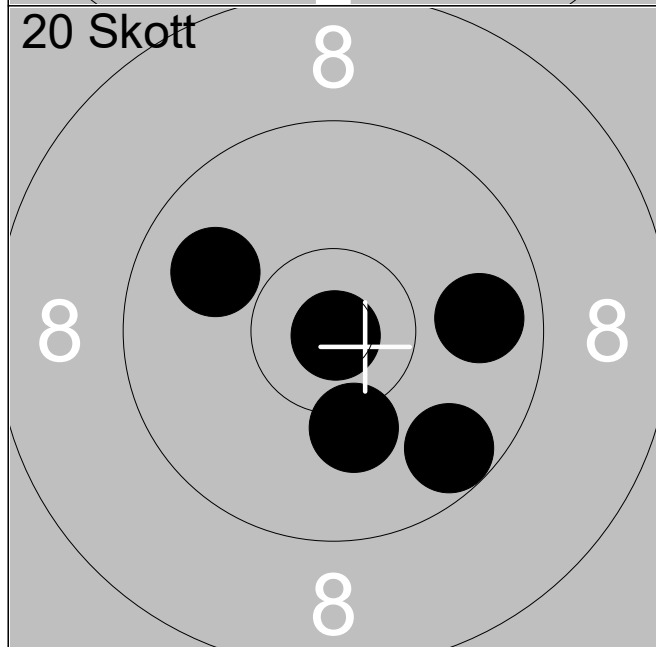

1:	9.8	→
2:	10.2	↓
3:	9.7	↘
4:	10.9x	↘
5:	9.9	↖

Serie	<b>47</b>
-------	-----------

Total	<b>47</b>
-------	-----------

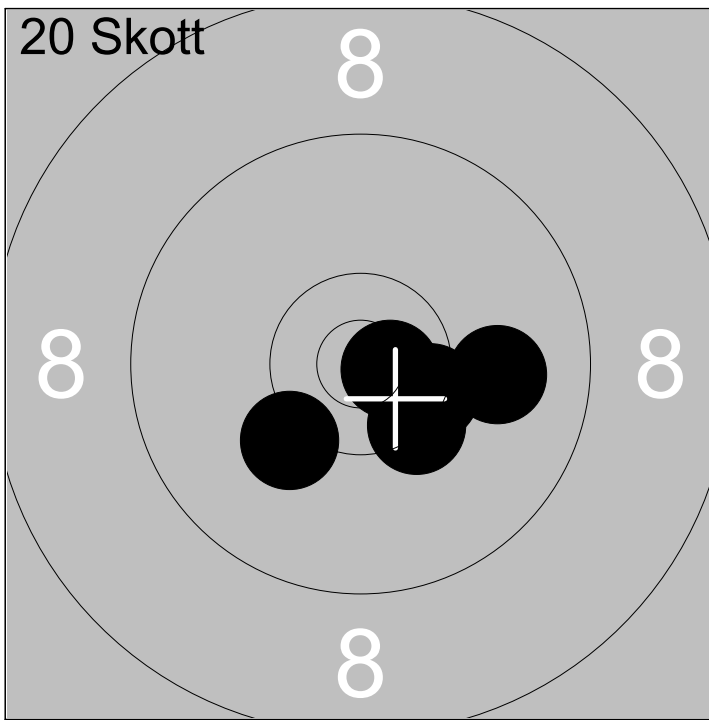

6:	10.0	→
7:	10.2	↙
8:	10.4x	↙
9:	10.7x	→
10:	10.4x	↘

Serie	50
Total	97

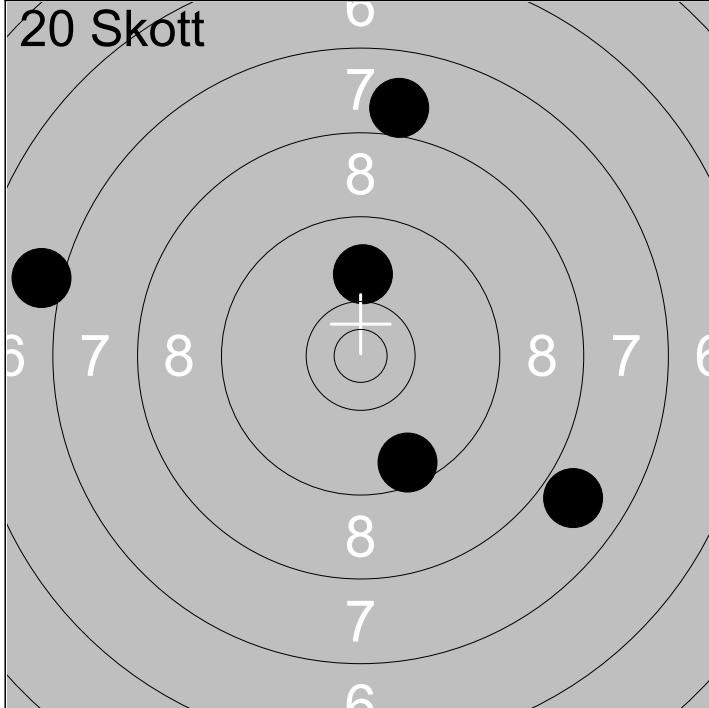

11:	8.0	↑
12:	9.6	↘
13:	10.0	↑
14:	7.1	↖
15:	7.9	↘

Serie	41
Total	138

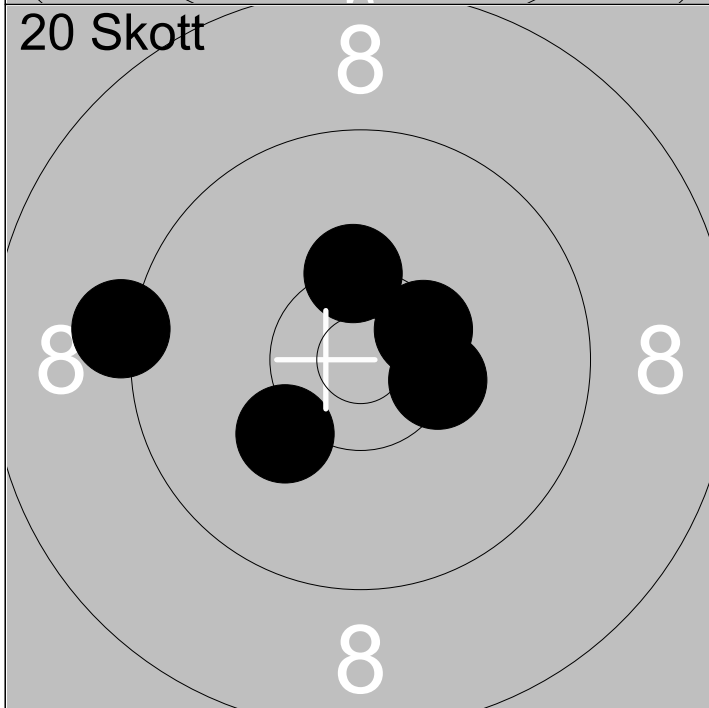

16:	10.5x	↗
17:	9.2	↖
18:	10.3x	↑
19:	10.2	↙
20:	10.4x	→

Serie	49
Total	187

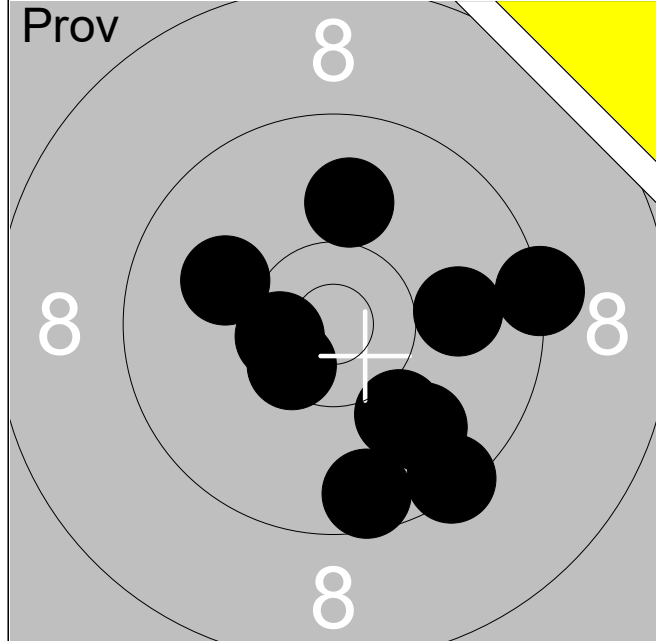

1:	9.3	→
2:	9.9	↘
3:	10.1	↘
4:	10.0	↑
5:	10.5x	←
6:	10.0	↖
7:	10.5x	↘
8:	9.6	↘
9:	9.4	↘
10:	10.0	→

Serie	<b>96</b>
-------	-----------

Total	<b>0</b>
-------	----------

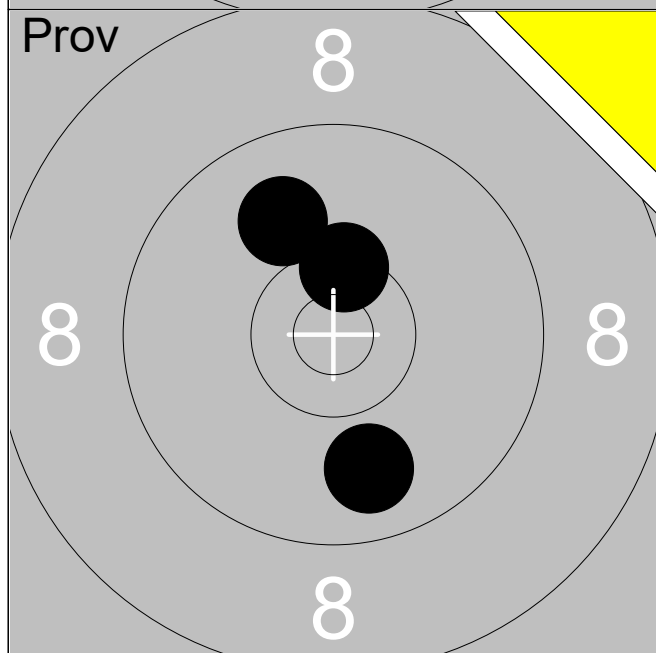

11:	9.9	↘
12:	10.4x	↑
13:	10.0	↗

Serie	<b>29</b>
-------	-----------

Total	<b>0</b>
-------	----------

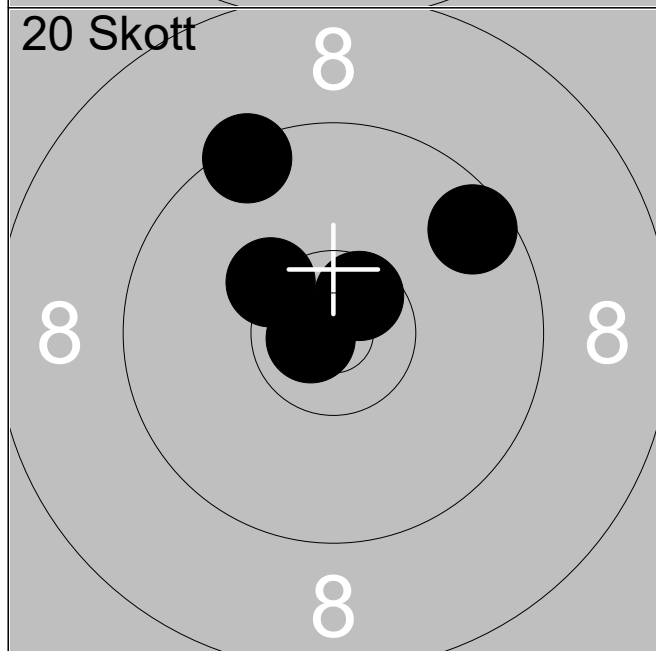

1:	10.8x	←
2:	9.6	↗
3:	9.4	↗
4:	10.3x	↖
5:	10.6x	↗

Serie	<b>48</b>
-------	-----------

Total	<b>48</b>
-------	-----------

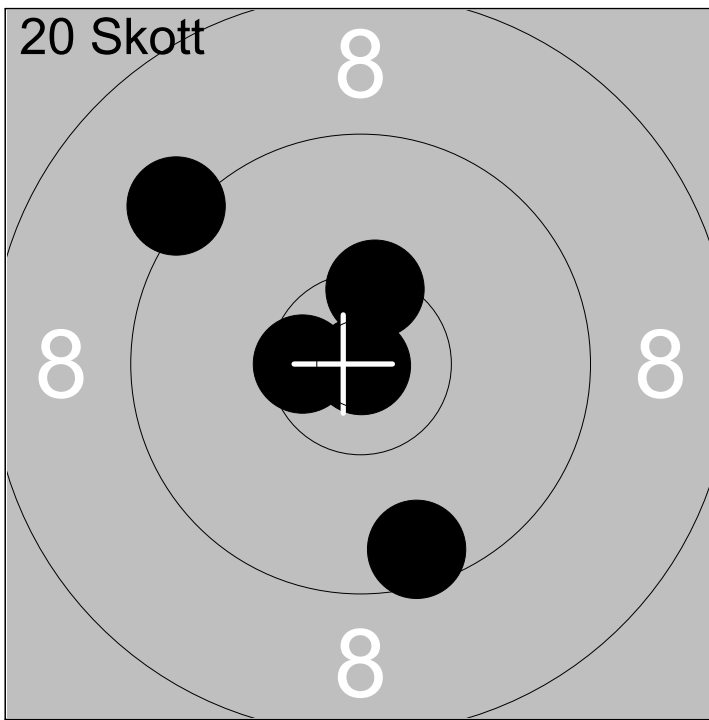

6:	10.5x	←
7:	9.2	↗
8:	9.6	↓
9:	10.9x	↓
10:	10.4x	↑

Serie	48
Total	96

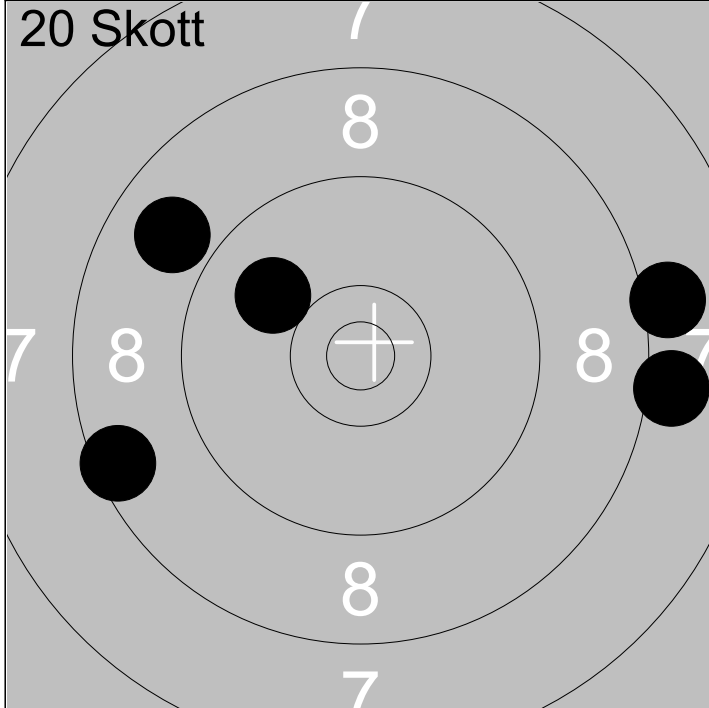

11:	8.9	↖
12:	8.1	→
13:	8.1	→
14:	10.0	↖
15:	8.5	←

Serie	42
Total	138

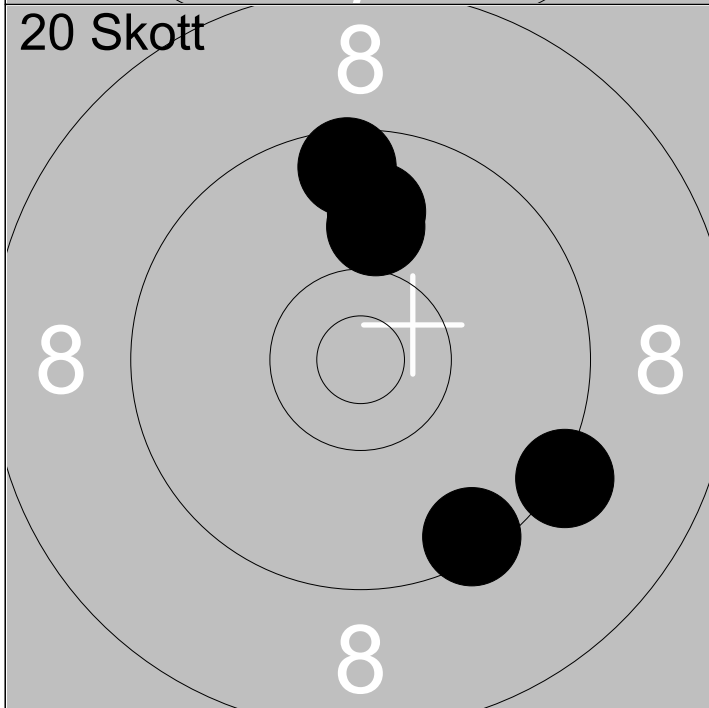

16:	10.0	↑
17:	9.4	↓
18:	9.3	↘
19:	9.6	↑
20:	9.9	↑

Serie	46
Total	184



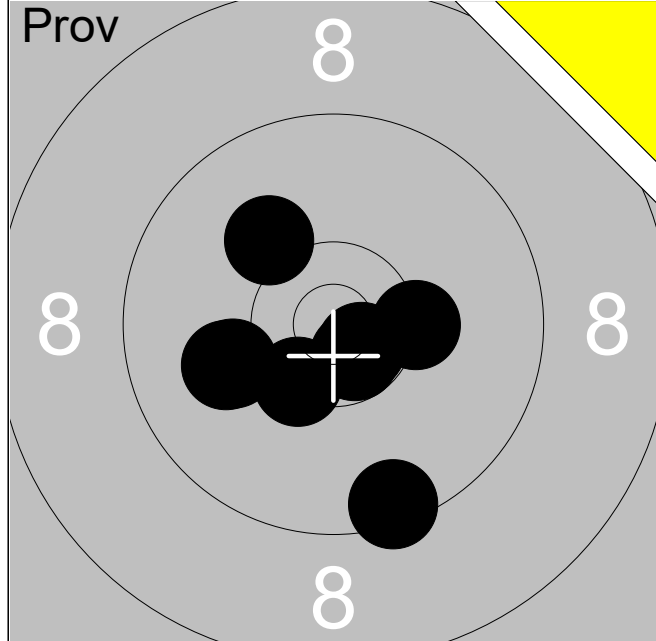

1:	10.6x	↘
2:	9.5	↘
3:	10.7x	↘
4:	10.1	←
5:	10.3x	→
6:	10.4x	↘
7:	10.1	↗
8:	10.1	←
<b>Serie</b>		<b>79</b>
<b>Total</b>		<b>0</b>

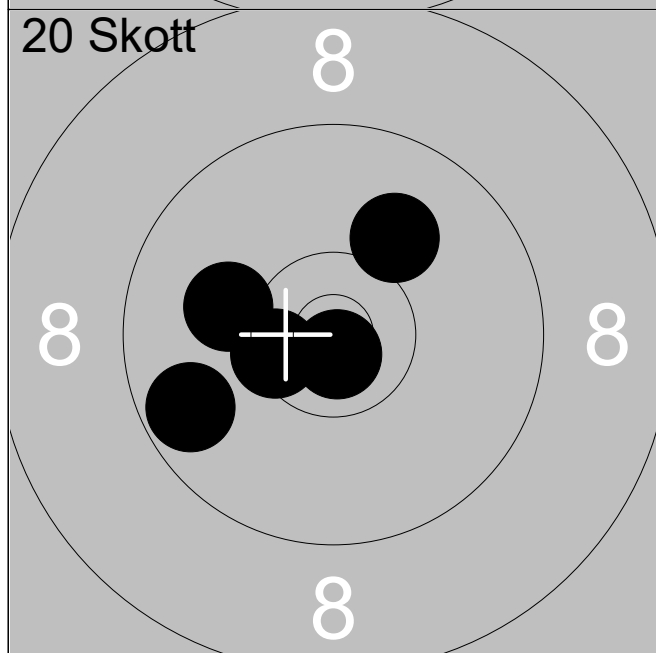

1:	10.8x	↓
2:	10.5x	←
3:	9.7	←
4:	10.1	←
5:	10.0	↗
<b>Serie</b>		<b>49</b>
<b>Total</b>		<b>49</b>

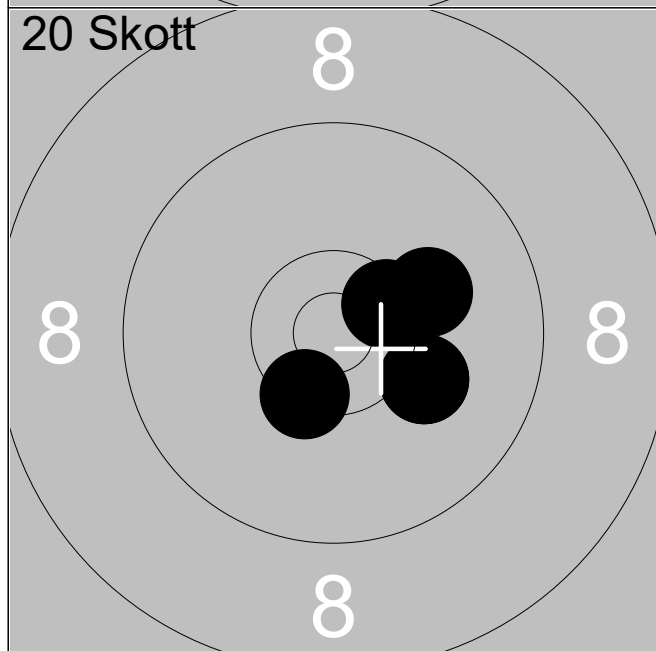

6:	10.5x	↗
7:	10.2	↘
8:	10.2	↘
9:	10.4x	↓
10:	10.1	→
<b>Serie</b>		<b>50</b>
<b>Total</b>		<b>99</b>

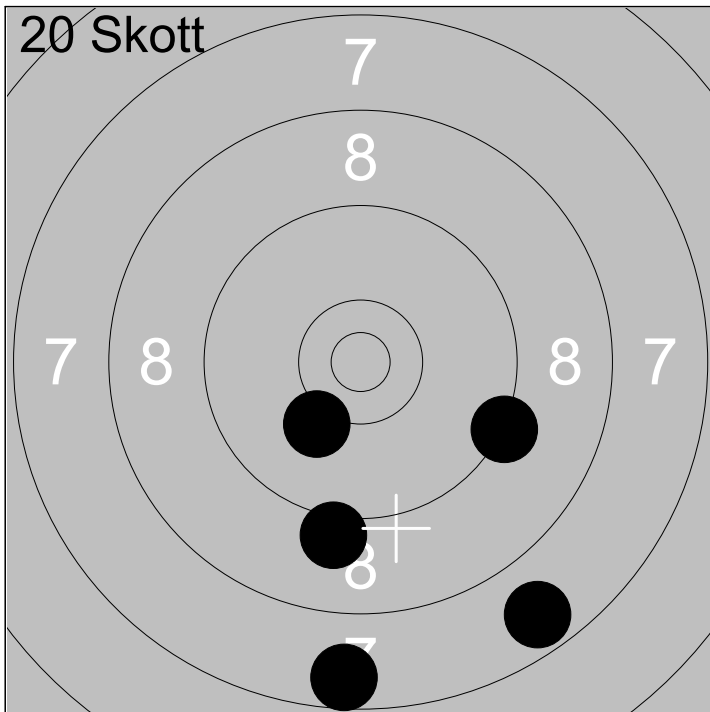

11:	9.1	↓
12:	7.6	↓
13:	7.7	↘
14:	10.2	↘
15:	9.3	↘

Serie	42
Total	141

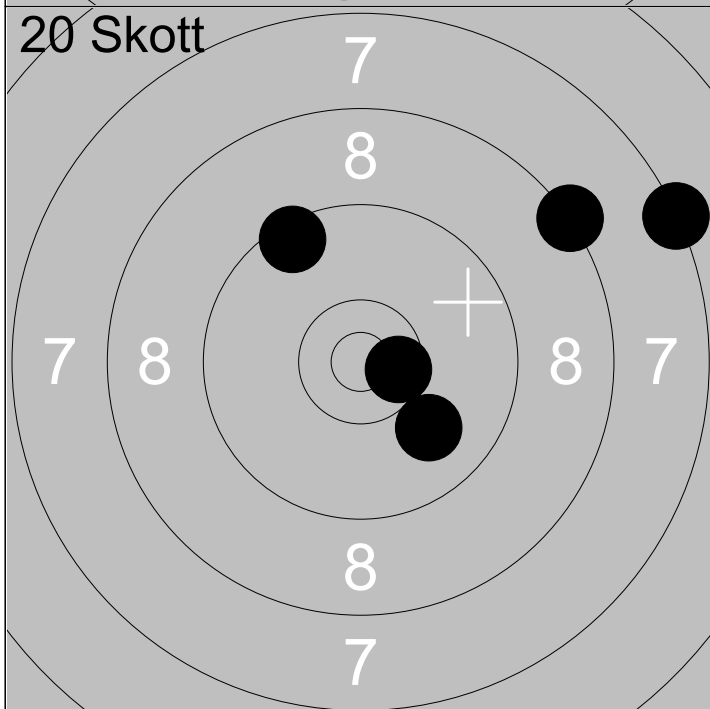

16:	10.0	↘
17:	10.5x	→
18:	8.3	↗
19:	9.5	↗
20:	7.3	↗

Serie	44
Total	185