

| | | |
|-----|-------|---|
| 1: | 9.7 | ↗ |
| 2: | 10.4x | ↖ |
| 3: | 9.6 | ↘ |
| 4: | 10.1 | ↘ |
| 5: | 9.6 | ↘ |
| 6: | 9.9 | ↘ |
| 7: | 9.3 | ↖ |
| 8: | 8.9 | ↖ |
| 9: | 10.1 | ↖ |
| 10: | 9.9 | ↖ |

| | |
|-------|-----------|
| Serie | 92 |
|-------|-----------|

| | |
|-------|----------|
| Total | 0 |
|-------|----------|

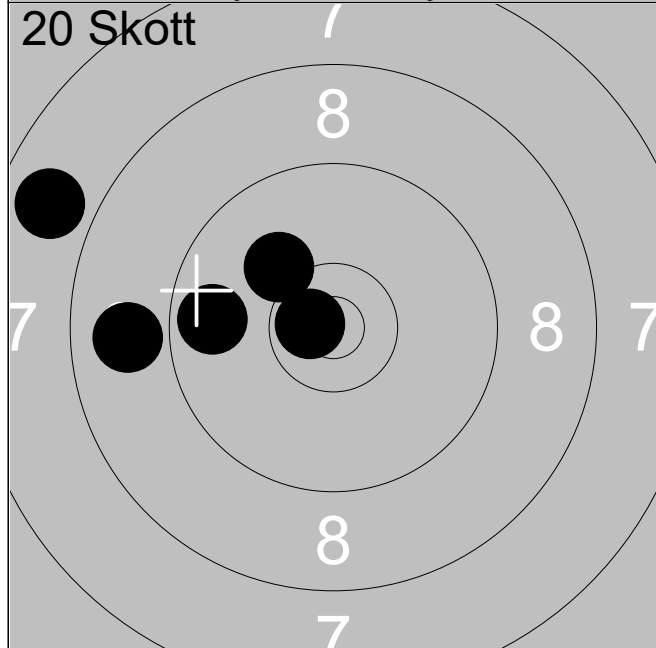

| | | |
|----|-------|---|
| 1: | 10.1 | ↗ |
| 2: | 7.8 | ↖ |
| 3: | 8.9 | ↖ |
| 4: | 9.7 | ↖ |
| 5: | 10.7x | ↖ |

| | |
|-------|-----------|
| Serie | 44 |
|-------|-----------|

| | |
|-------|-----------|
| Total | 44 |
|-------|-----------|

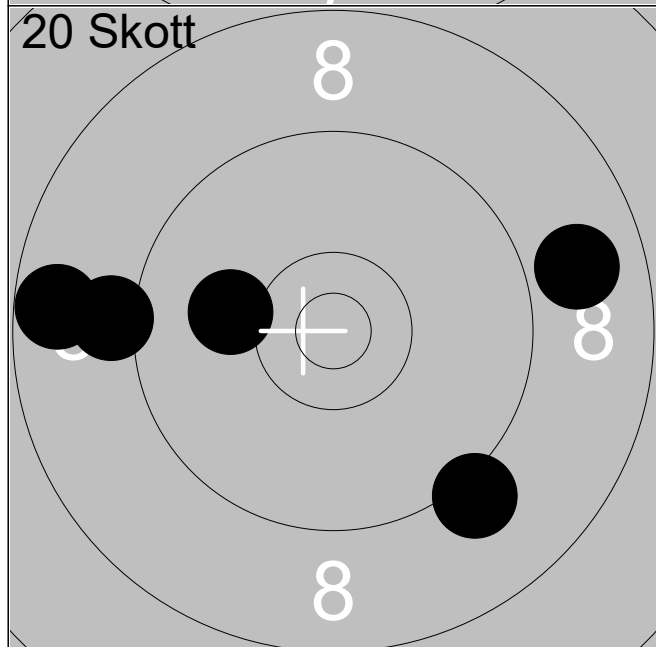

| | | |
|-----|------|---|
| 6: | 8.7 | ↖ |
| 7: | 9.2 | ↘ |
| 8: | 9.1 | ↖ |
| 9: | 10.1 | ↖ |
| 10: | 8.9 | ↗ |

| | |
|-------|-----------|
| Serie | 44 |
|-------|-----------|

| | |
|-------|-----------|
| Total | 88 |
|-------|-----------|

20 Skott

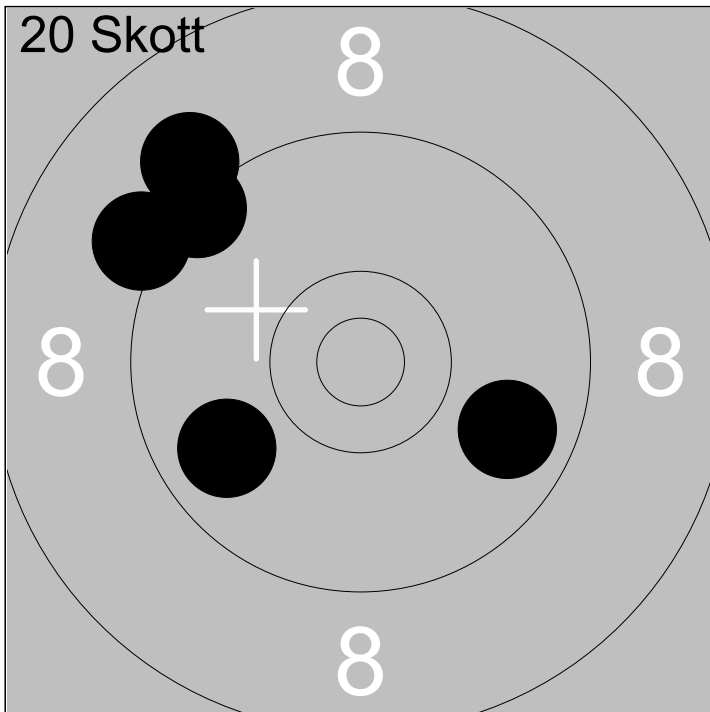

| | | |
|-----|-----|---|
| 11: | 9.8 | ↙ |
| 12: | 9.2 | ↗ |
| 13: | 9.8 | ↘ |
| 14: | 9.3 | ↖ |
| 15: | 9.1 | ↗ |

Serie 45

Total 133

20 Skott

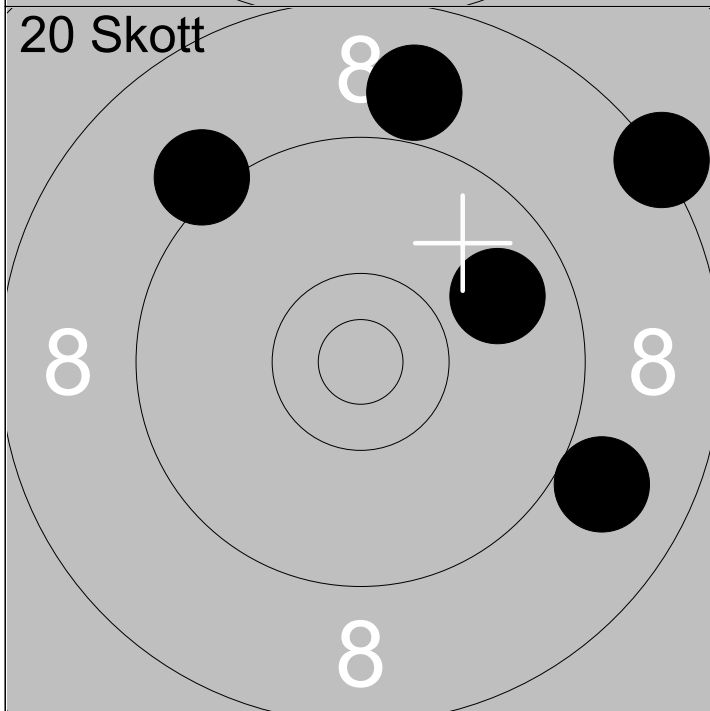

| | | |
|-----|-----|---|
| 16: | 8.3 | ↗ |
| 17: | 9.0 | ↘ |
| 18: | 9.8 | ↖ |
| 19: | 8.9 | ↑ |
| 20: | 9.2 | ↖ |

Serie 43

Total 176

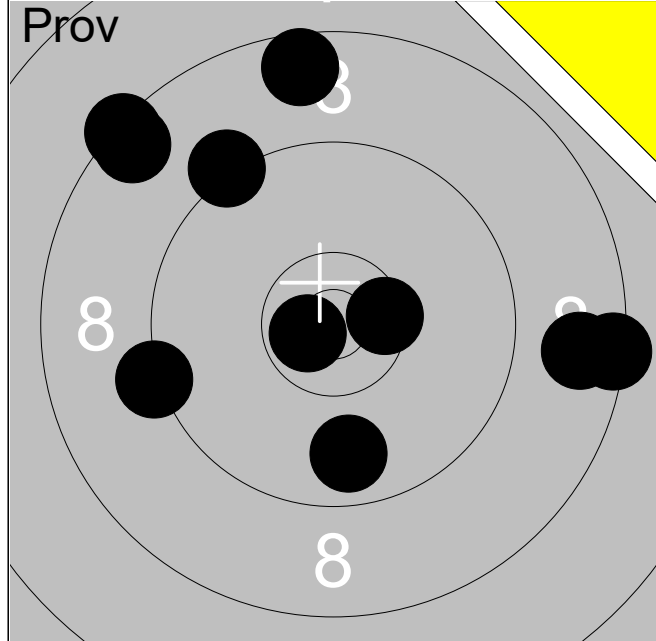

| | | |
|-----|-------|---|
| 1: | 8.4 | → |
| 2: | 8.6 | ↑ |
| 3: | 8.7 | → |
| 4: | 10.7x | ← |
| 5: | 9.3 | ← |
| 6: | 8.5 | ↗ |
| 7: | 8.4 | ↗ |
| 8: | 9.2 | ↗ |
| 9: | 9.8 | ↓ |
| 10: | 10.5x | → |

| | |
|-------|-----------|
| Serie | 87 |
|-------|-----------|

| | |
|-------|----------|
| Total | 0 |
|-------|----------|

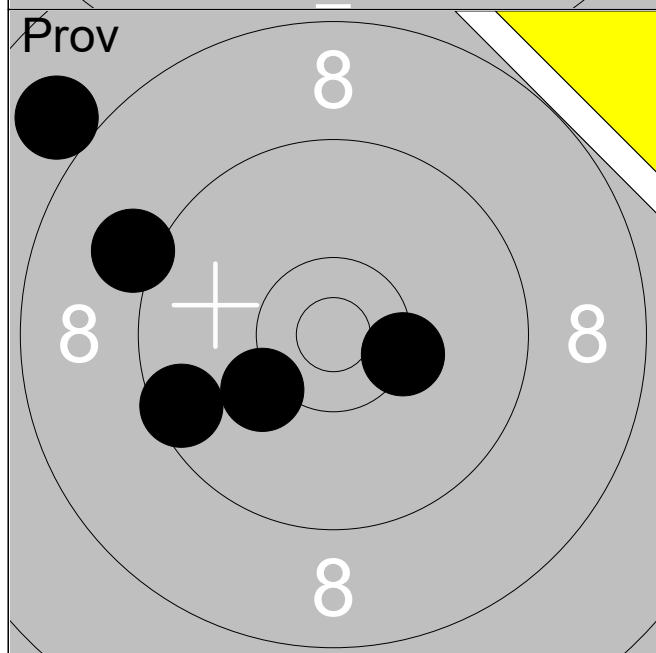

| | | |
|-----|-------|---|
| 11: | 10.3x | → |
| 12: | 9.5 | ← |
| 13: | 8.0 | ↗ |
| 14: | 10.2 | ← |
| 15: | 9.1 | ← |

| | |
|-------|-----------|
| Serie | 46 |
|-------|-----------|

| | |
|-------|----------|
| Total | 0 |
|-------|----------|

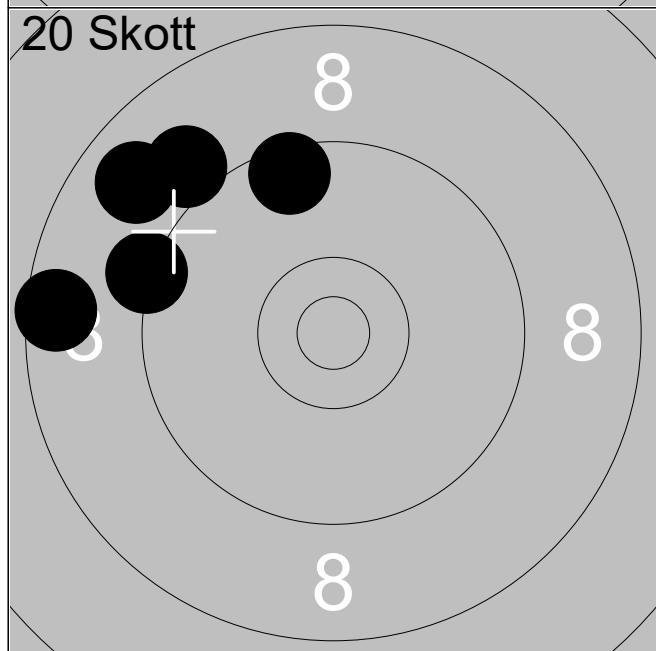

| | | |
|----|-----|---|
| 1: | 8.5 | ← |
| 2: | 9.3 | ← |
| 3: | 9.5 | ↑ |
| 4: | 9.0 | ↗ |
| 5: | 8.8 | ↗ |

| | |
|-------|-----------|
| Serie | 43 |
|-------|-----------|

| | |
|-------|-----------|
| Total | 43 |
|-------|-----------|

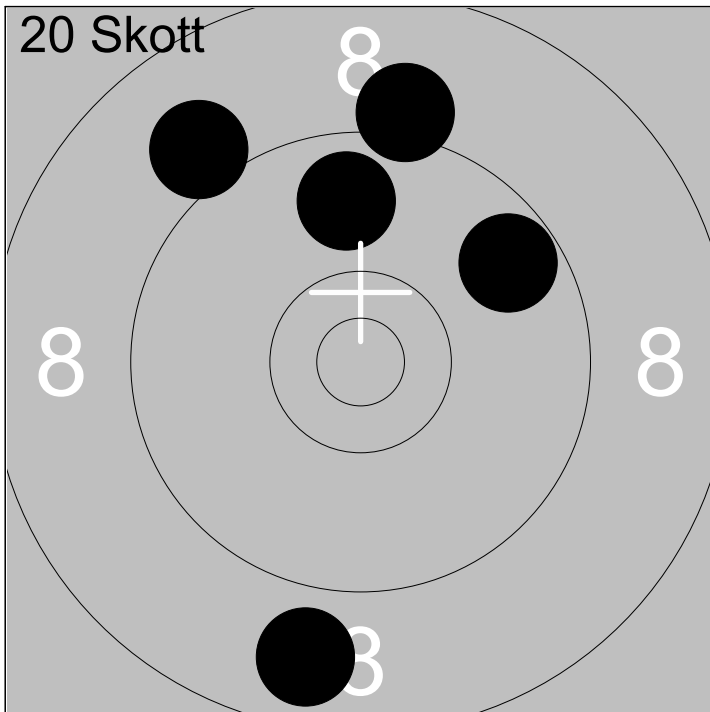

| | | |
|-----|-----|---|
| 6: | 8.8 | ↓ |
| 7: | 9.8 | ↑ |
| 8: | 9.1 | ↑ |
| 9: | 9.7 | ↗ |
| 10: | 9.0 | ↖ |

Serie 44

Total 87

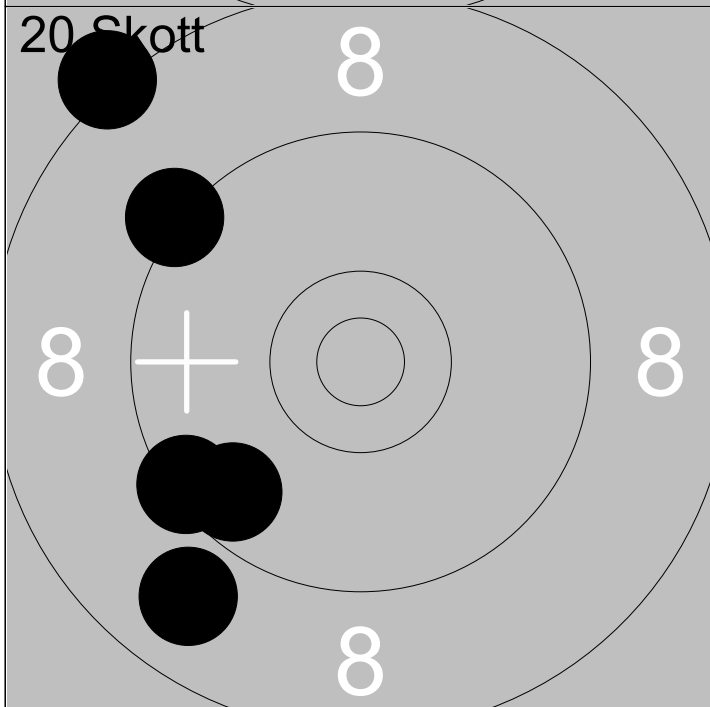

| | | |
|-----|-----|---|
| 11: | 9.6 | ↙ |
| 12: | 9.4 | ↙ |
| 13: | 8.2 | ↖ |
| 14: | 9.3 | ↖ |
| 15: | 8.9 | ↙ |

Serie 43

Total 130

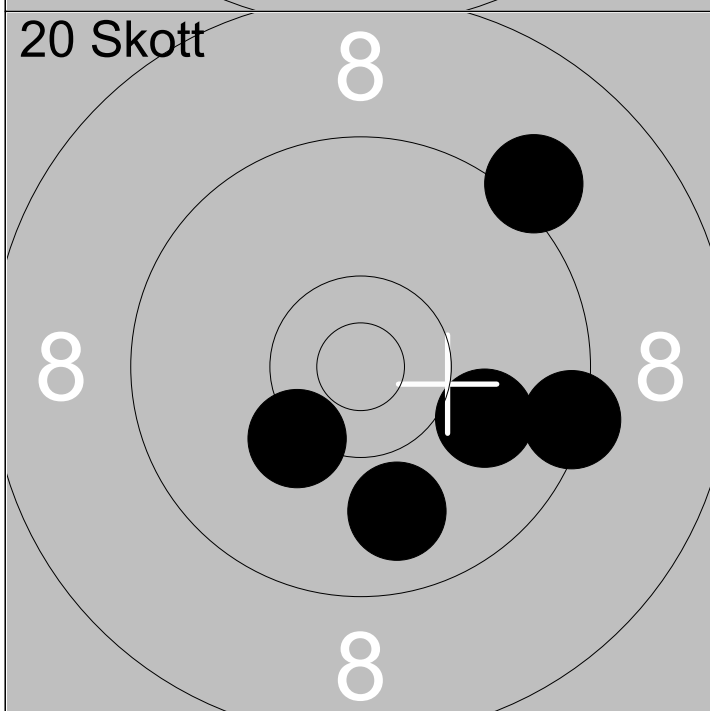

| | | |
|-----|------|---|
| 16: | 10.3 | ↙ |
| 17: | 9.4 | → |
| 18: | 10.0 | → |
| 19: | 9.9 | ↓ |
| 20: | 9.1 | ↗ |

Serie 47

Total 177

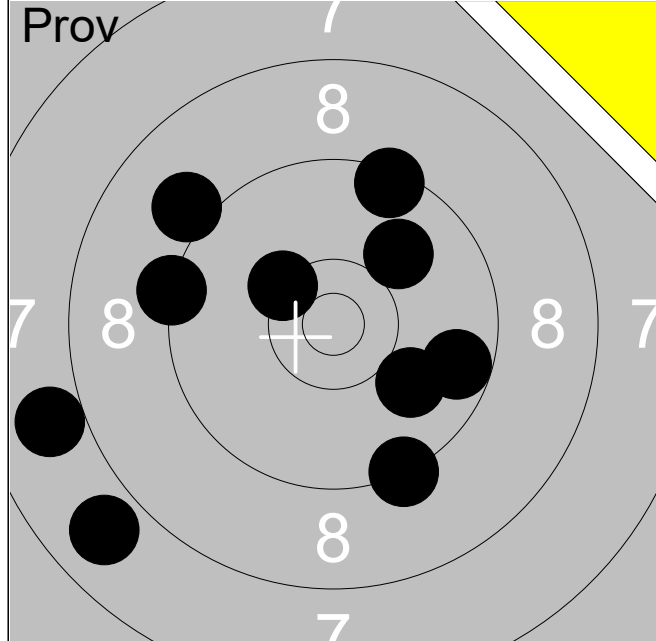

| | | |
|-----|-------|---|
| 1: | 7.9 | ↙ |
| 2: | 7.9 | ↘ |
| 3: | 9.7 | → |
| 4: | 9.3 | ↘ |
| 5: | 9.3 | ← |
| 6: | 10.0 | ↗ |
| 7: | 10.0 | ↘ |
| 8: | 9.4 | ↗ |
| 9: | 9.1 | ↗ |
| 10: | 10.3x | ↗ |

| | |
|-------|-----------|
| Serie | 89 |
|-------|-----------|

| | |
|-------|----------|
| Total | 0 |
|-------|----------|

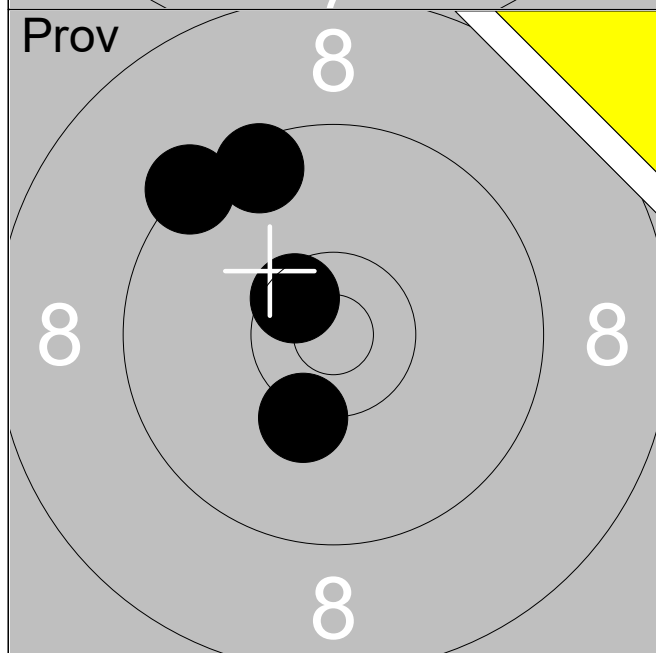

| | | |
|-----|-------|---|
| 11: | 9.3 | ↗ |
| 12: | 9.5 | ↗ |
| 13: | 10.5x | ↗ |
| 14: | 10.3 | ↘ |

| | |
|-------|-----------|
| Serie | 38 |
|-------|-----------|

| | |
|-------|----------|
| Total | 0 |
|-------|----------|

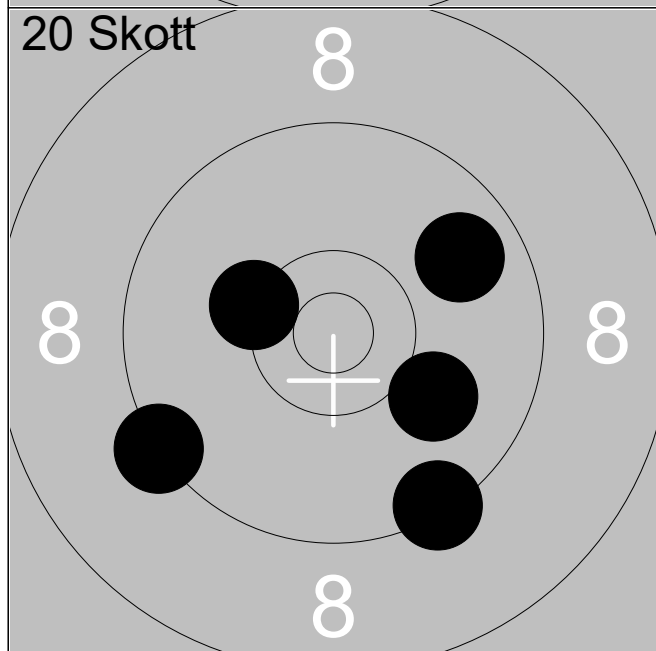

| | | |
|----|-------|---|
| 1: | 10.3x | ↙ |
| 2: | 9.8 | ↗ |
| 3: | 9.3 | ↙ |
| 4: | 9.4 | ↘ |
| 5: | 10.0 | ↘ |

| | |
|-------|-----------|
| Serie | 47 |
|-------|-----------|

| | |
|-------|-----------|
| Total | 47 |
|-------|-----------|

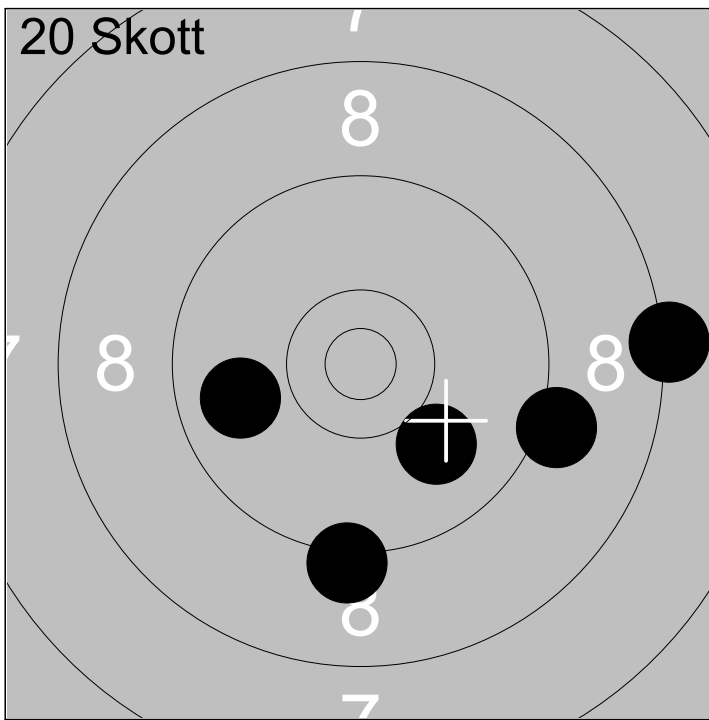

| | | |
|-----|------|---|
| 6: | 10.0 | ↘ |
| 7: | 9.1 | ↗ |
| 8: | 8.2 | → |
| 9: | 9.9 | ← |
| 10: | 9.2 | ↓ |

| | |
|-------|----|
| Serie | 45 |
| Total | 92 |

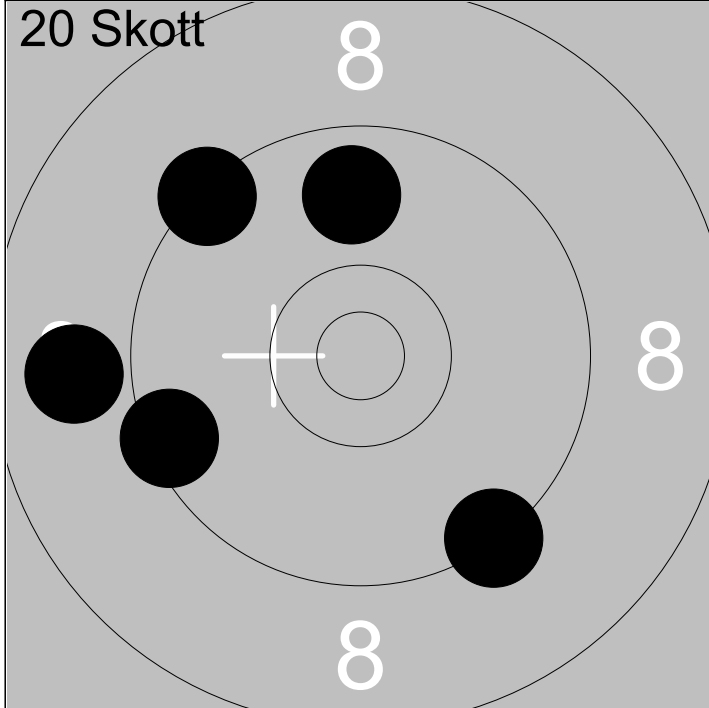

| | | |
|-----|-----|---|
| 11: | 9.3 | ↘ |
| 12: | 9.4 | ↗ |
| 13: | 9.5 | ← |
| 14: | 9.8 | ↑ |
| 15: | 8.9 | ← |

| | |
|-------|-----|
| Serie | 44 |
| Total | 136 |

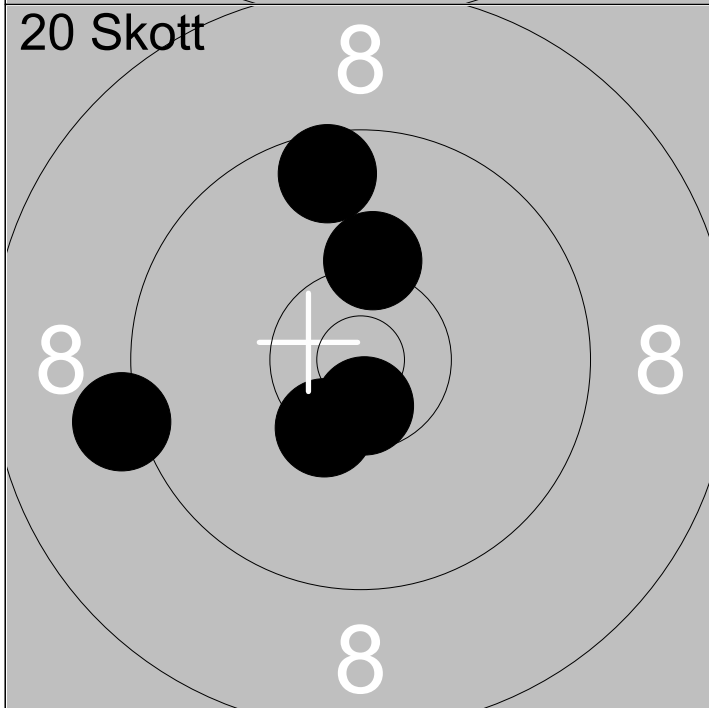

| | | |
|-----|-------|---|
| 16: | 10.2 | ↑ |
| 17: | 9.2 | ← |
| 18: | 10.4x | ↘ |
| 19: | 9.6 | ↑ |
| 20: | 10.6x | ↓ |

| | |
|-------|-----|
| Serie | 48 |
| Total | 184 |

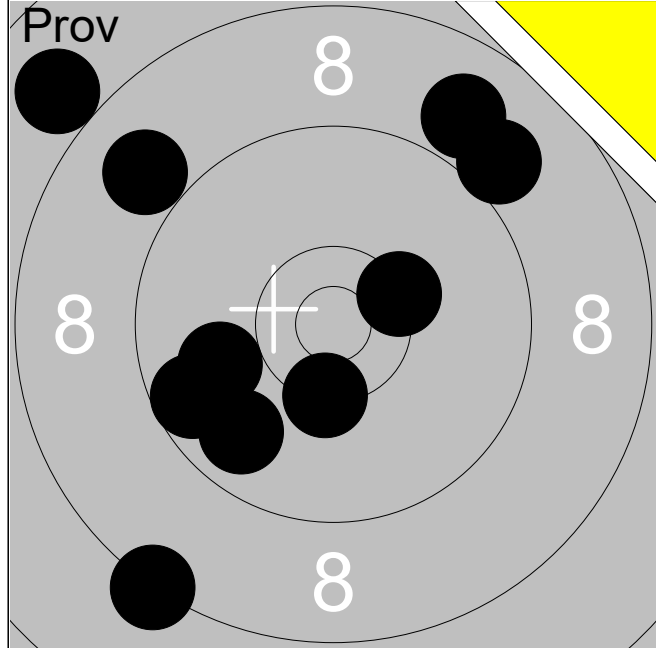

| | | |
|-----|-------|---|
| 1: | 7.9 | ↗ |
| 2: | 8.9 | ↗ |
| 3: | 9.6 | ↖ |
| 4: | 9.0 | ↗ |
| 5: | 8.9 | ↗ |
| 6: | 8.3 | ↘ |
| 7: | 9.8 | ↘ |
| 8: | 10.4x | ↓ |
| 9: | 10.0 | ↖ |
| 10: | 10.3x | ↗ |

| | |
|-------|----|
| Serie | 88 |
|-------|----|

| | |
|-------|---|
| Total | 0 |
|-------|---|

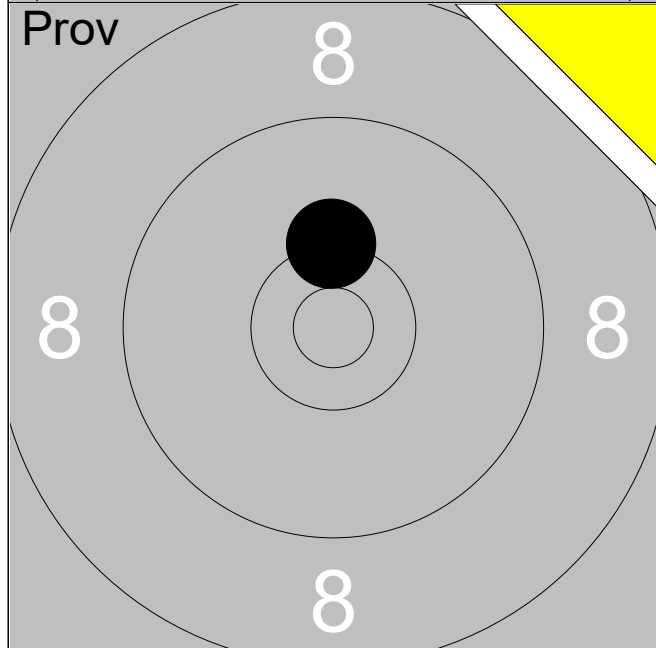

| | | |
|-----|-------|---|
| 11: | 10.3x | ↑ |
|-----|-------|---|

| | |
|-------|----|
| Serie | 10 |
|-------|----|

| | |
|-------|---|
| Total | 0 |
|-------|---|

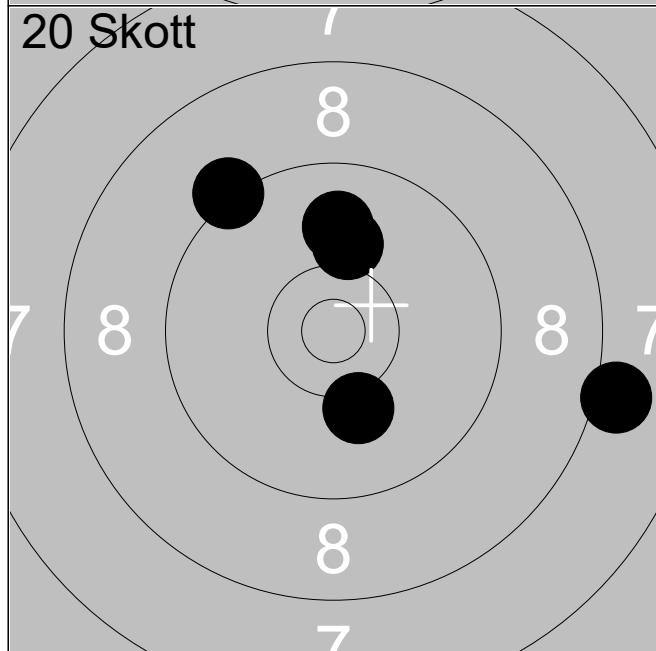

| | | |
|----|------|---|
| 1: | 9.9 | ↑ |
| 2: | 9.2 | ↗ |
| 3: | 10.1 | ↑ |
| 4: | 8.1 | → |
| 5: | 10.1 | ↓ |

| | |
|-------|----|
| Serie | 46 |
|-------|----|

| | |
|-------|----|
| Total | 46 |
|-------|----|

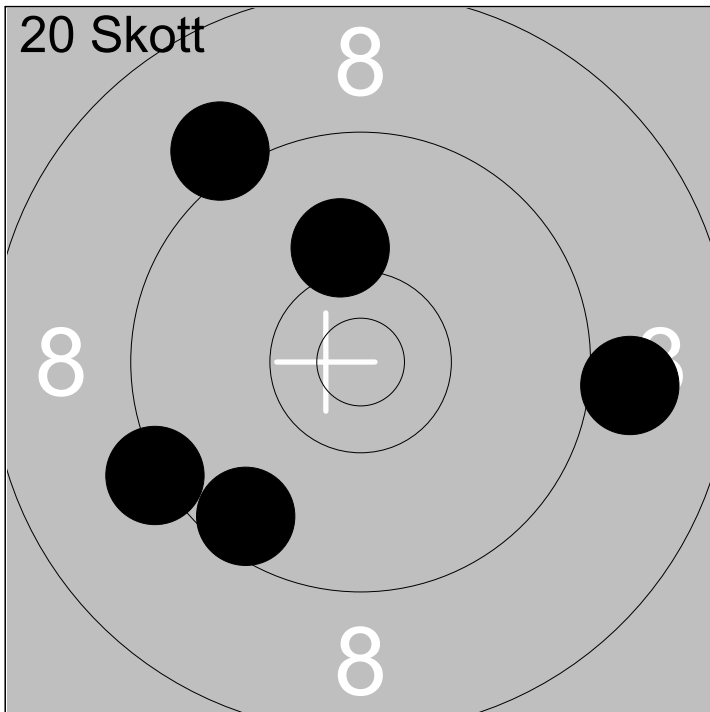

| | | |
|-----|------|---|
| 6: | 9.6 | ↙ |
| 7: | 9.0 | → |
| 8: | 9.3 | ↙ |
| 9: | 9.1 | ↗ |
| 10: | 10.1 | ↑ |

Serie 46

Total 92

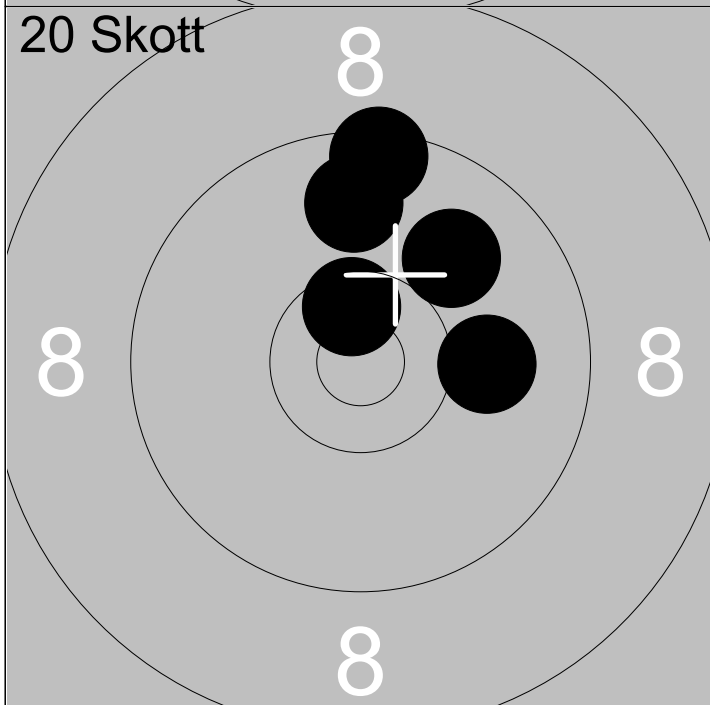

| | | |
|-----|-------|---|
| 11: | 10.0 | → |
| 12: | 9.5 | ↑ |
| 13: | 9.8 | ↑ |
| 14: | 10.0 | ↗ |
| 15: | 10.6x | ↑ |

Serie 48

Total 140

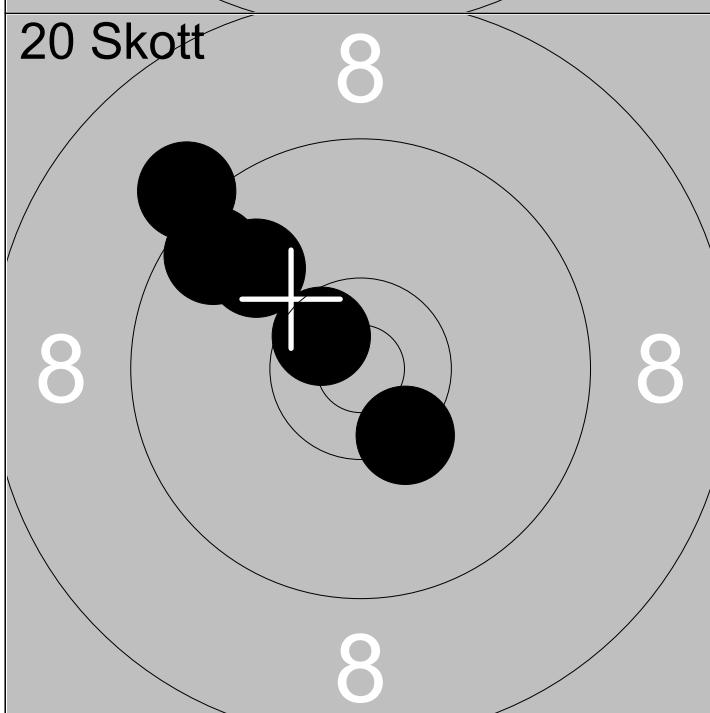

| | | |
|-----|-------|---|
| 16: | 9.6 | ↗ |
| 17: | 10.4x | ↙ |
| 18: | 9.9 | ↗ |
| 19: | 9.2 | ↗ |
| 20: | 10.6x | ↗ |

Serie 47

Total 187

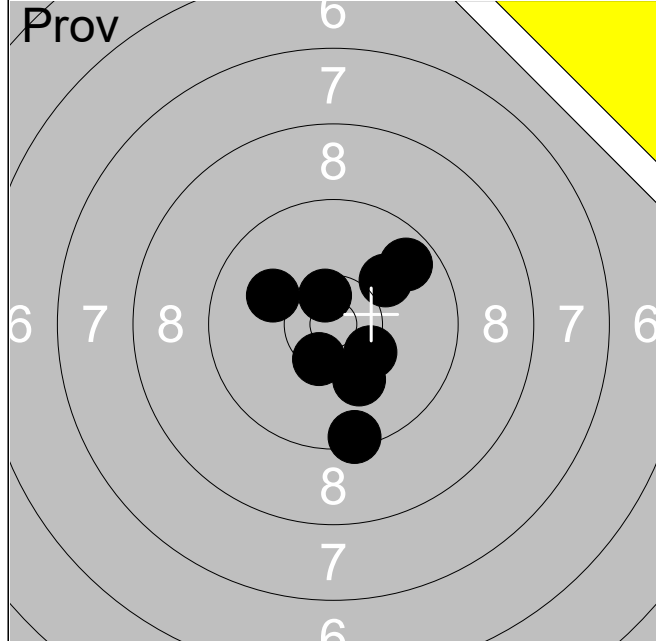

| | | |
|----|-------|---|
| 1: | 6.1 | ↗ |
| 2: | 10.6x | ↑ |
| 3: | 9.7 | ↗ |
| 4: | 10.5x | ↓ |
| 5: | 10.3x | ↘ |
| 6: | 10.1 | ↖ |
| 7: | 10.1 | ↓ |
| 8: | 9.4 | ↓ |
| 9: | 10.0 | ↗ |

| | |
|-------|-----------|
| Serie | 84 |
|-------|-----------|

| | |
|-------|----------|
| Total | 0 |
|-------|----------|

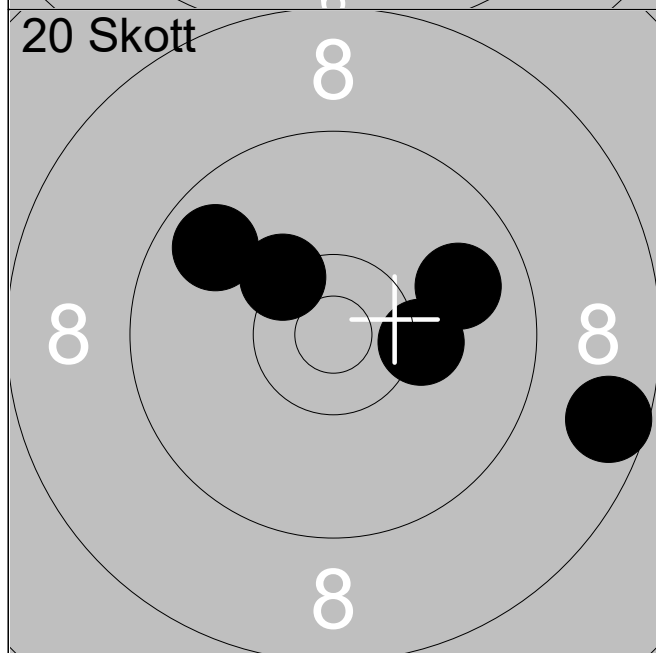

| | | |
|----|-------|---|
| 1: | 10.3x | ↗ |
| 2: | 9.9 | → |
| 3: | 10.2 | → |
| 4: | 8.6 | ↘ |
| 5: | 9.8 | ↗ |

| | |
|-------|-----------|
| Serie | 46 |
|-------|-----------|

| | |
|-------|-----------|
| Total | 46 |
|-------|-----------|

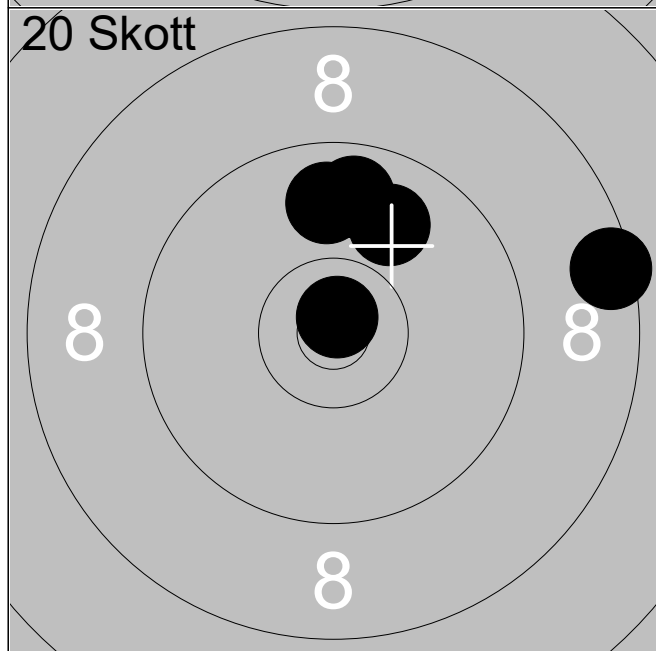

| | | |
|-----|-------|---|
| 6: | 8.5 | → |
| 7: | 9.8 | ↑ |
| 8: | 9.9 | ↗ |
| 9: | 10.8x | ↑ |
| 10: | 9.8 | ↑ |

| | |
|-------|-----------|
| Serie | 45 |
|-------|-----------|

| | |
|-------|-----------|
| Total | 91 |
|-------|-----------|

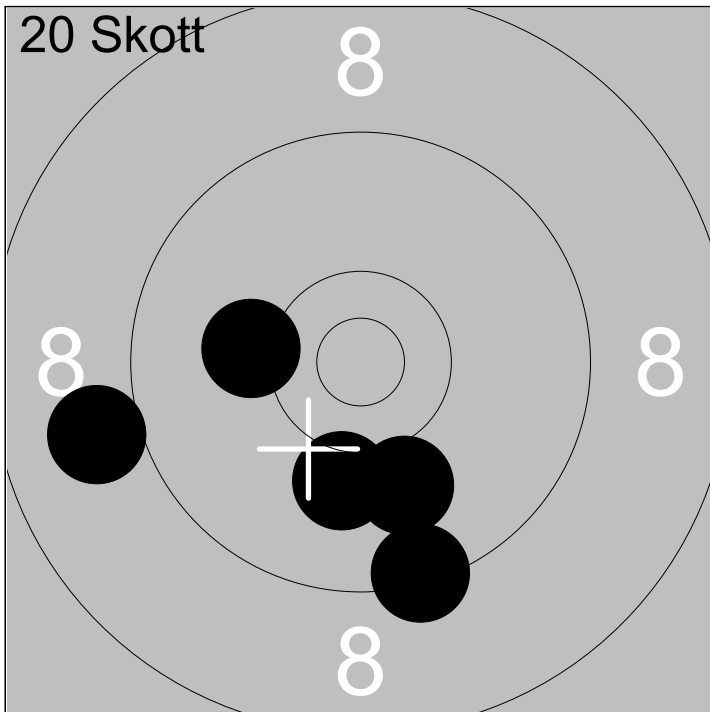

| | | |
|-----|------|---|
| 11: | 9.4 | ↓ |
| 12: | 10.1 | ↓ |
| 13: | 9.0 | ← |
| 14: | 10.2 | ← |
| 15: | 10.0 | ↓ |

| | |
|-------|-----|
| Serie | 48 |
| Total | 139 |

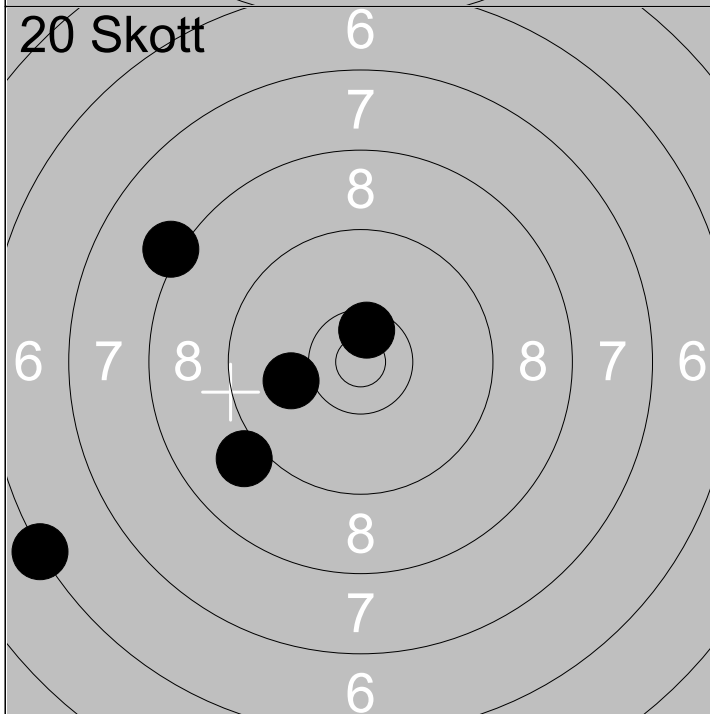

| | | |
|-----|-------|---|
| 16: | 10.1 | ← |
| 17: | 6.3 | ← |
| 18: | 10.5x | ↑ |
| 19: | 9.1 | ← |
| 20: | 8.2 | ↖ |

| | |
|-------|-----|
| Serie | 43 |
| Total | 182 |

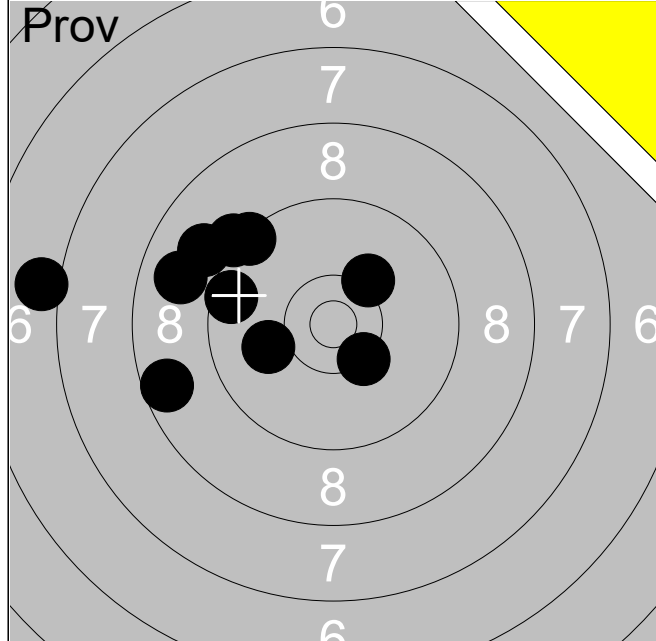

| | | |
|-----|-------|---|
| 1: | 8.6 | ← |
| 2: | 7.1 | ← |
| 3: | 9.0 | ↗ |
| 4: | 9.6 | ← |
| 5: | 8.8 | ← |
| 6: | 10.2 | ↗ |
| 7: | 10.0 | ← |
| 8: | 9.2 | ↗ |
| 9: | 10.3x | ↘ |
| 10: | 9.4 | ↗ |

| | |
|-------|-----------|
| Serie | 89 |
|-------|-----------|

| | |
|-------|----------|
| Total | 0 |
|-------|----------|

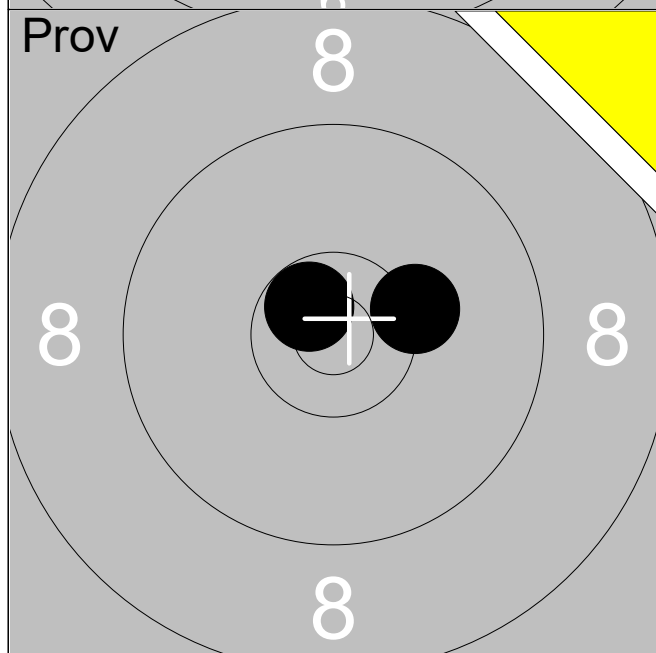

| | | |
|-----|-------|---|
| 11: | 10.7x | ↗ |
| 12: | 10.3 | → |

| | |
|-------|-----------|
| Serie | 20 |
|-------|-----------|

| | |
|-------|----------|
| Total | 0 |
|-------|----------|

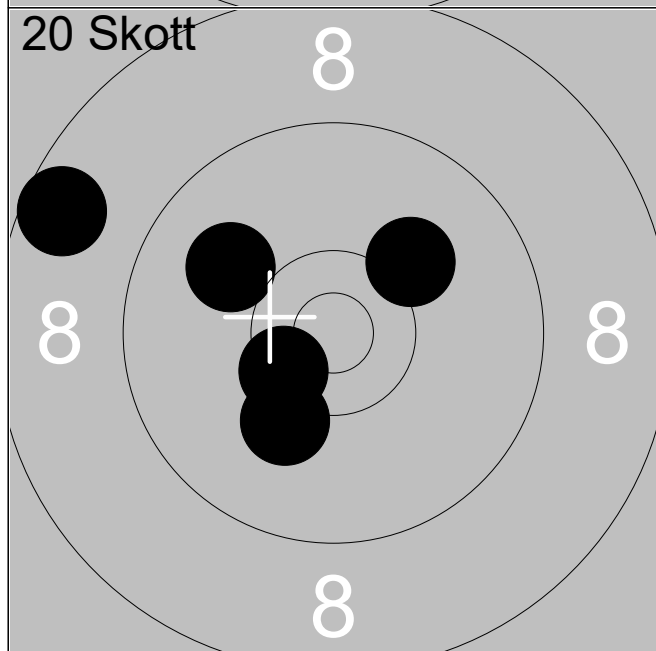

| | | |
|----|-------|---|
| 1: | 10.5x | ← |
| 2: | 10.2 | ↘ |
| 3: | 10.1 | ↗ |
| 4: | 10.0 | ← |
| 5: | 8.6 | ← |

| | |
|-------|-----------|
| Serie | 48 |
|-------|-----------|

| | |
|-------|-----------|
| Total | 48 |
|-------|-----------|

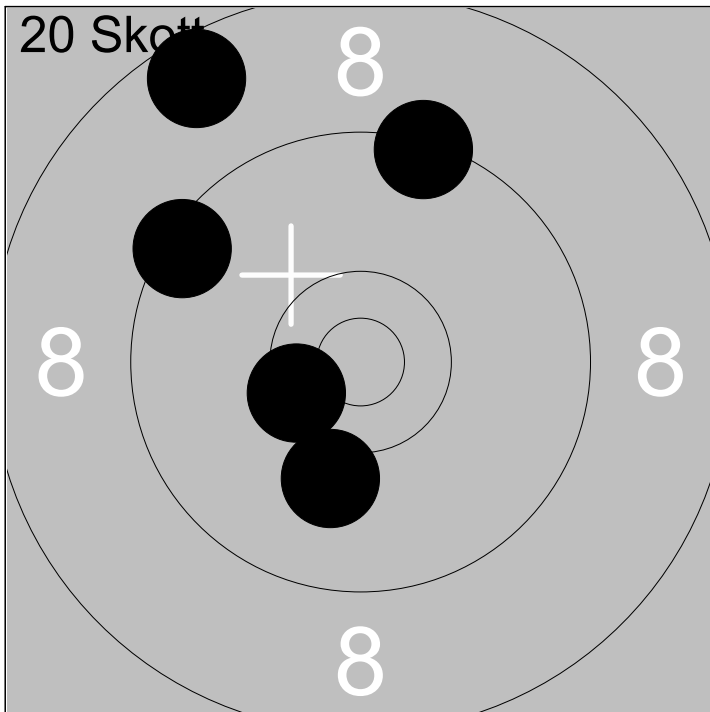

| | | |
|-----|-------|---|
| 6: | 9.4 | ↗ |
| 7: | 9.4 | ↖ |
| 8: | 10.4x | ↙ |
| 9: | 8.6 | ↗ |
| 10: | 10.1 | ↘ |

Serie 46

Total 94

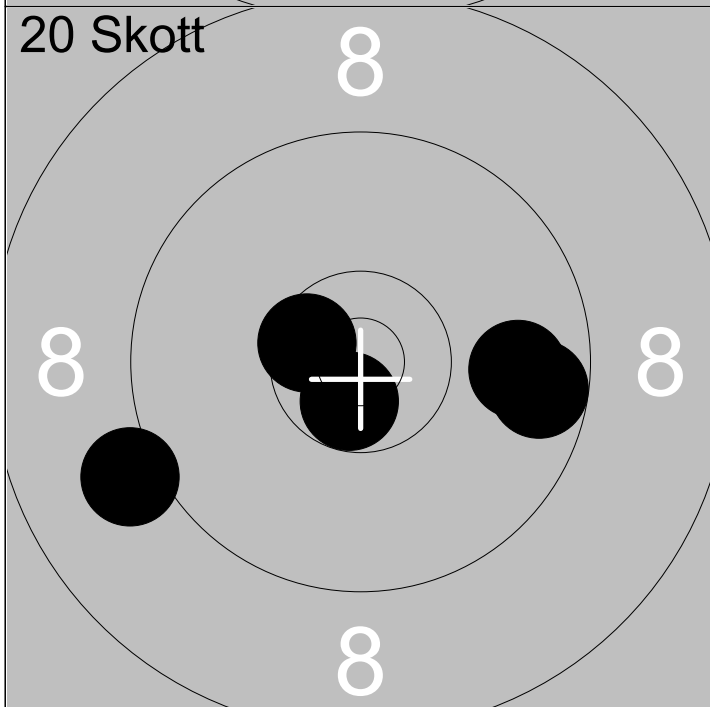

| | | |
|-----|-------|---|
| 11: | 10.7x | ↘ |
| 12: | 10.5x | ↖ |
| 13: | 9.8 | → |
| 14: | 9.7 | → |
| 15: | 9.1 | ↙ |

Serie 47

Total 141

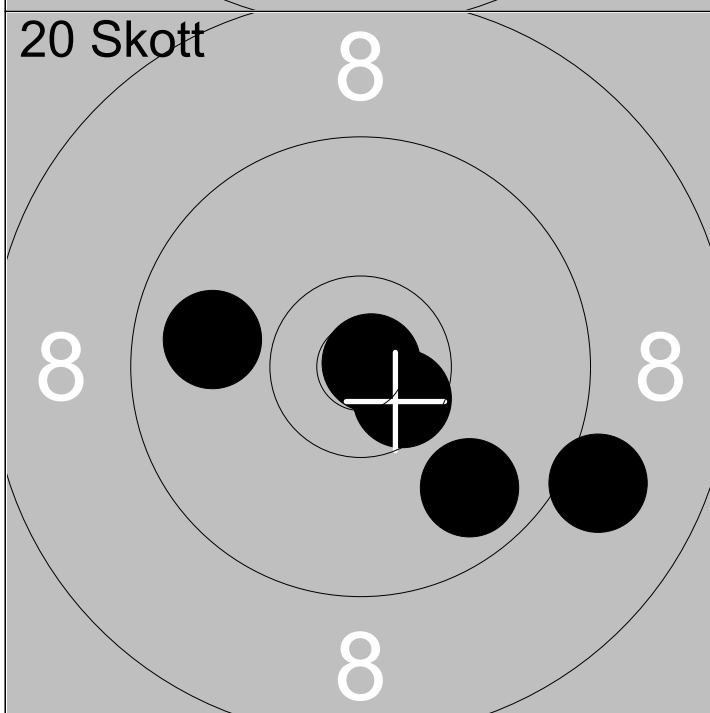

| | | |
|-----|-------|---|
| 16: | 10.9x | → |
| 17: | 9.9 | ↖ |
| 18: | 9.8 | ↘ |
| 19: | 9.1 | ↘ |
| 20: | 10.6x | ↘ |

Serie 47

Total 188

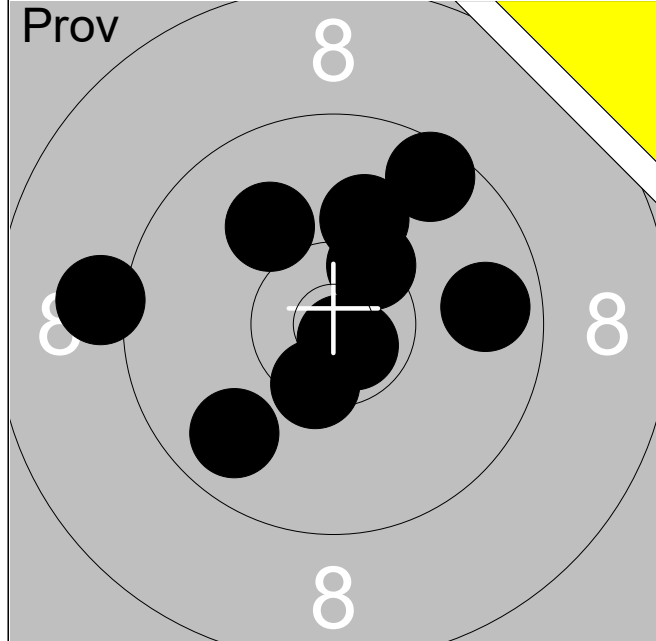

| | | |
|-----|-------|---|
| 1: | 9.7 | → |
| 2: | 10.8x | ↓ |
| 3: | 10.0 | ↗ |
| 4: | 9.8 | ↓ |
| 5: | 10.5x | ↓ |
| 6: | 10.4x | ↗ |
| 7: | 9.1 | ← |
| 8: | 9.6 | ↗ |
| 9: | 10.1 | ↗ |
| 10: | 10.7x | ↓ |

| | |
|-------|-----------|
| Serie | 96 |
|-------|-----------|

| | |
|-------|----------|
| Total | 0 |
|-------|----------|

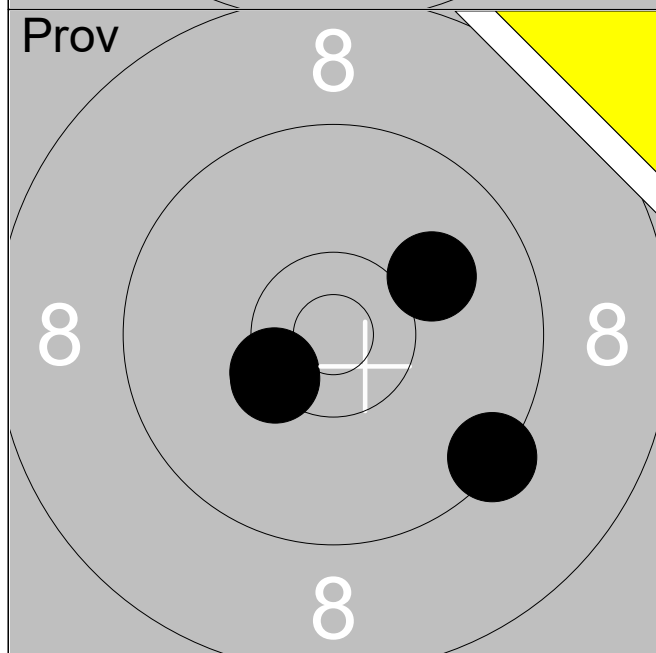

| | | |
|-----|-------|---|
| 11: | 10.4x | ← |
| 12: | 10.4x | ← |
| 13: | 9.4 | ↓ |
| 14: | 10.1 | ↗ |

| | |
|-------|-----------|
| Serie | 39 |
|-------|-----------|

| | |
|-------|----------|
| Total | 0 |
|-------|----------|

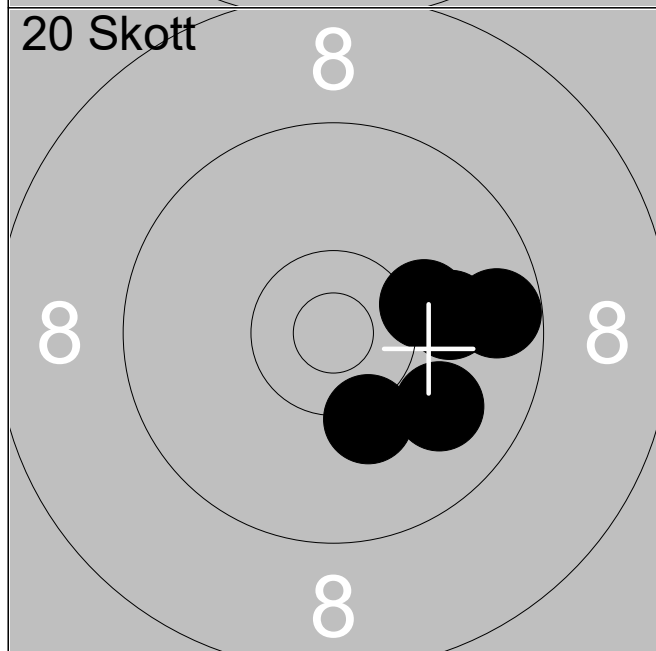

| | | |
|----|------|---|
| 1: | 10.2 | ↓ |
| 2: | 10.2 | → |
| 3: | 9.9 | ↓ |
| 4: | 9.7 | → |
| 5: | 10.0 | → |

| | |
|-------|-----------|
| Serie | 48 |
|-------|-----------|

| | |
|-------|-----------|
| Total | 48 |
|-------|-----------|

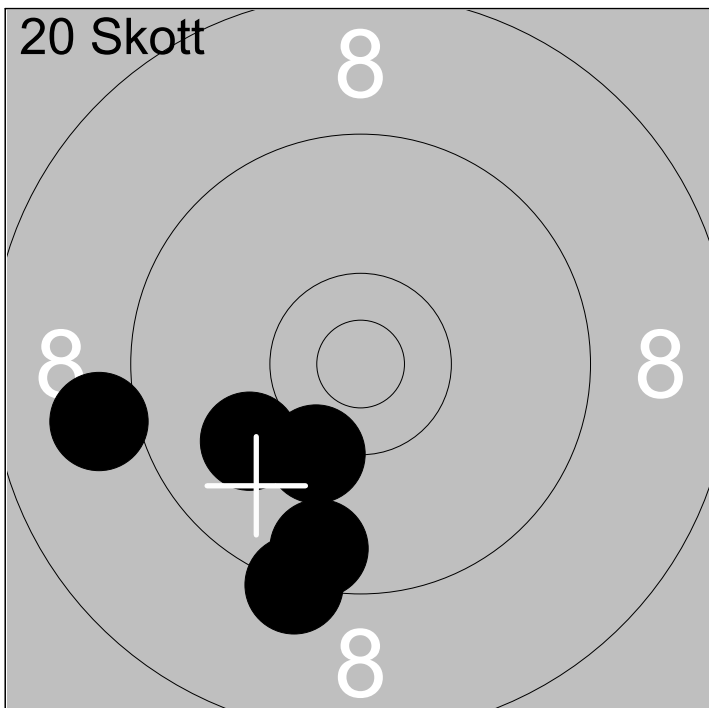

| | | |
|-----|------|---|
| 6: | 9.3 | ↓ |
| 7: | 10.2 | ↓ |
| 8: | 9.0 | ← |
| 9: | 9.6 | ↓ |
| 10: | 10.0 | ↙ |

| | |
|-------|----|
| Serie | 47 |
| Total | 95 |

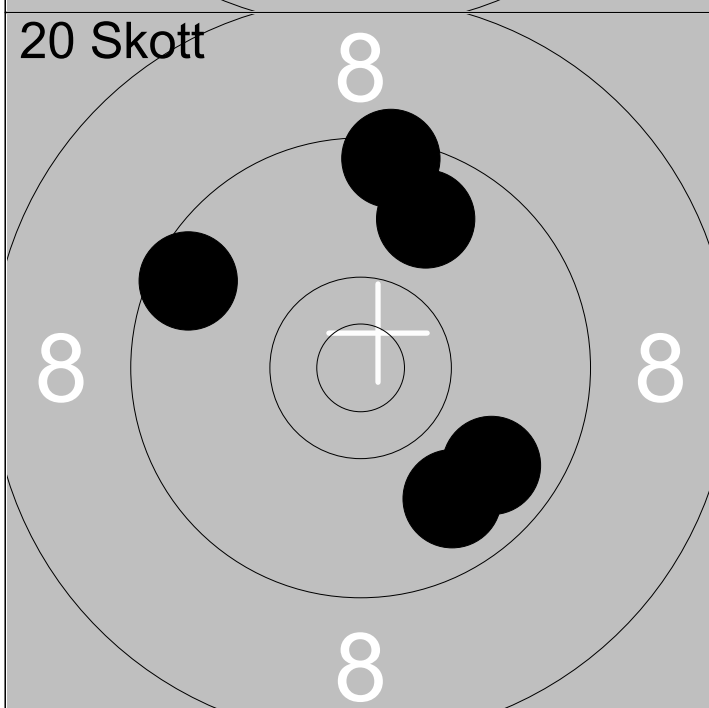

| | | |
|-----|-----|---|
| 11: | 9.8 | ↓ |
| 12: | 9.8 | ↓ |
| 13: | 9.8 | ↗ |
| 14: | 9.6 | ↖ |
| 15: | 9.4 | ↑ |

| | |
|-------|-----|
| Serie | 45 |
| Total | 140 |

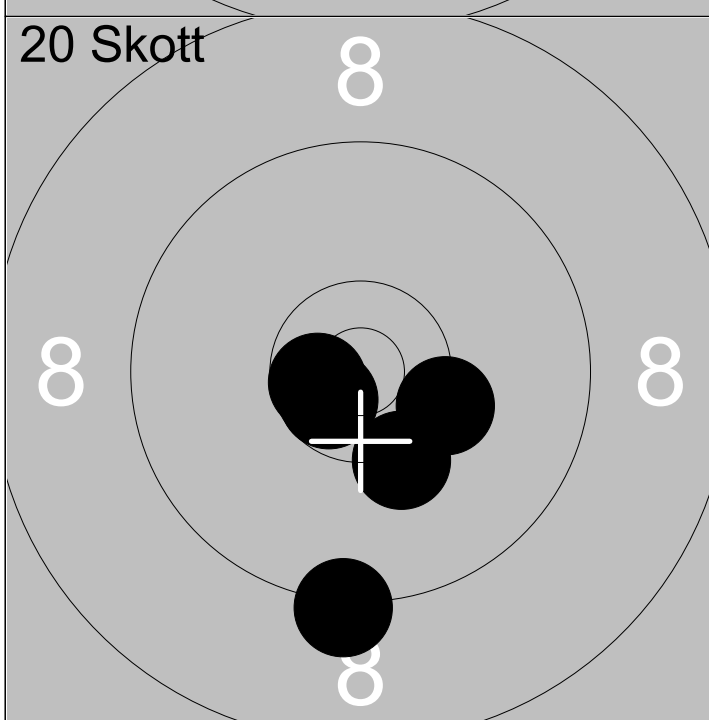

| | | |
|-----|-------|---|
| 16: | 10.3x | ↘ |
| 17: | 10.3 | ↓ |
| 18: | 10.6x | ← |
| 19: | 9.3 | ↓ |
| 20: | 10.6x | ↙ |

| | |
|-------|-----|
| Serie | 49 |
| Total | 189 |

| | | | | |
|----------------------|-------------------|--------------------------------|------------------|-----------|
| Skjutlag 8 | Tavla 8 | Anton Salomonsson | | |
| SM 2018 50m | | Barkåkra-Hjärnarps Skyttegille | | KL 15 |
| 27.07.2018 | | SM 2018 Ligg Nationellt | Kristinehamn skf | |
| Prov | 1: | 7.5 | ↗ | |
| | 2: | 7.5 | → | |
| | 3: | 9.1 | → | |
| | 4: | 8.8 | ↗ | |
| | 5: | 9.3 | ↗ | |
| | 6: | 9.4 | ↗ | |
| | 7: | 8.8 | ↑ | |
| | 8: | 10.3x | ↗ | |
| | 9: | 8.6 | ↑ | |
| | 10: | 9.4 | ↘ | |
| | Serie | | | |
| Total | | | | 0 |
| Prov | 11: | 10.5x | ↖ | |
| | 12: | 10.7x | → | |
| | 13: | 10.2 | ↓ | |
| | 14: | 9.4 | → | |
| | 15: | 10.2 | ↖ | |
| | 16: | 9.8 | ↘ | |
| | 17: | 9.7 | ↓ | |
| | 18: | 9.7 | → | |
| | 19: | 10.2 | → | |
| Serie | | | | 86 |
| Total | | | | 0 |
| 20 Skott | 1: | 9.5 | ↘ | |
| | 2: | 9.8 | ↖ | |
| | 3: | 10.6x | ↓ | |
| | 4: | 10.6x | ↓ | |
| | 5: | 9.9 | ↘ | |
| | Serie | | | |
| Total | | | | 47 |

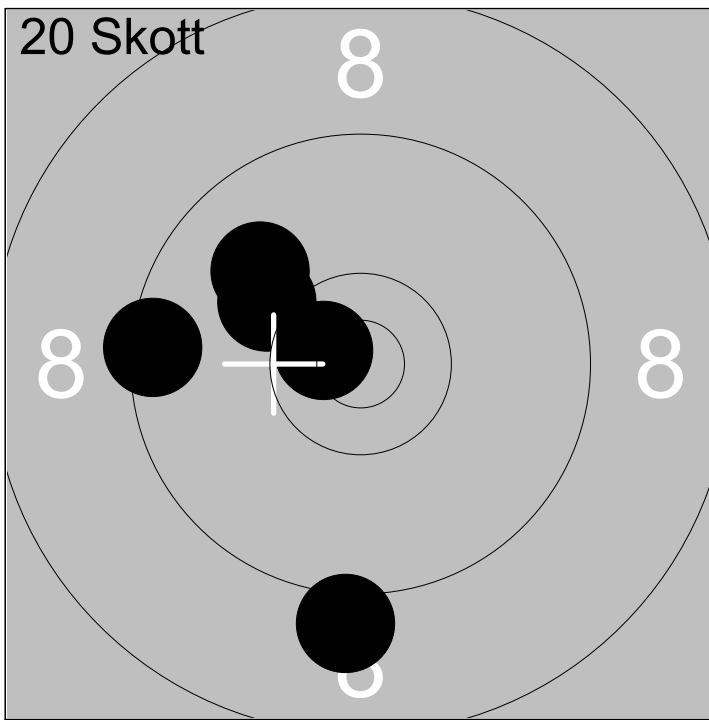

| | | |
|-----|-------|---|
| 6: | 10.1 | ↗ |
| 7: | 9.1 | ↓ |
| 8: | 9.5 | ← |
| 9: | 10.0 | ↗ |
| 10: | 10.7x | ← |

| | |
|-------|----|
| Serie | 48 |
| Total | 95 |

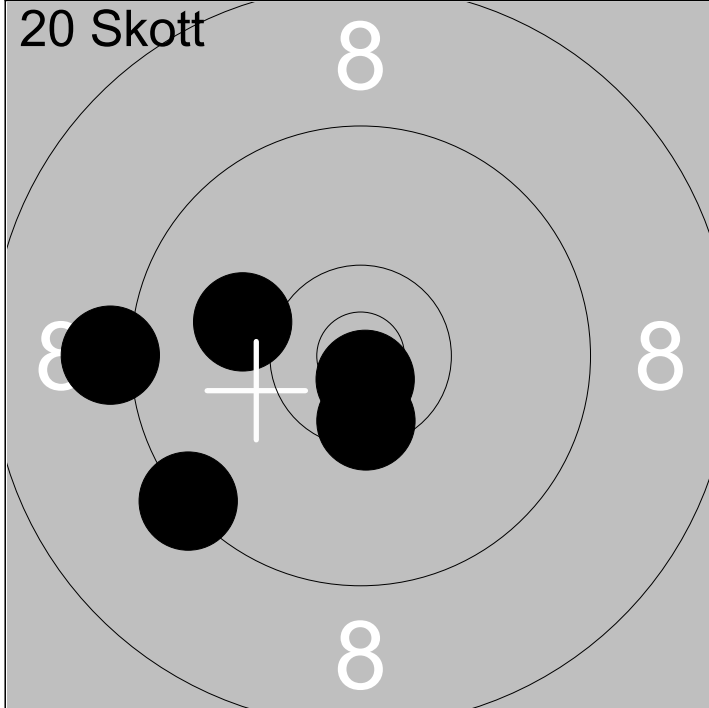

| | | |
|-----|-------|---|
| 11: | 9.3 | ↖ |
| 12: | 10.8x | ↓ |
| 13: | 10.5x | ↓ |
| 14: | 9.2 | ← |
| 15: | 10.1 | ↖ |

| | |
|-------|-----|
| Serie | 48 |
| Total | 143 |

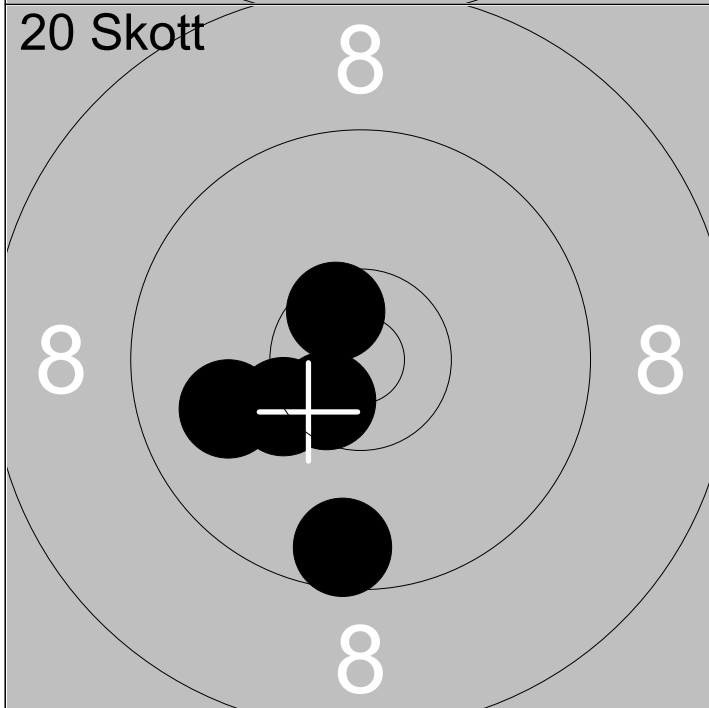

| | | |
|-----|-------|---|
| 16: | 9.9 | ↖ |
| 17: | 10.6x | ↖ |
| 18: | 10.3x | ← |
| 19: | 9.6 | ↓ |
| 20: | 10.6x | ↗ |

| | |
|-------|-----|
| Serie | 48 |
| Total | 191 |

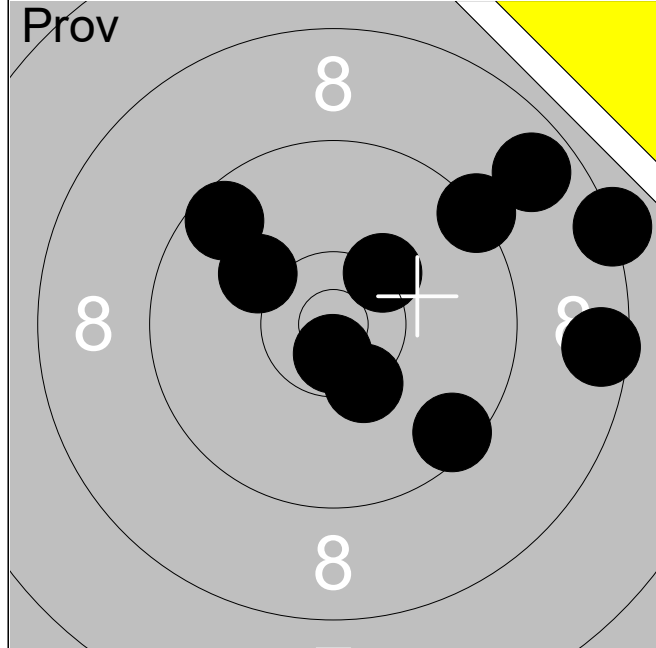

| | | |
|-----|-------|---|
| 1: | 8.5 | → |
| 2: | 9.3 | ↗ |
| 3: | 8.3 | → |
| 4: | 10.3x | ↗ |
| 5: | 9.6 | ↗ |
| 6: | 9.5 | ↘ |
| 7: | 8.7 | ↗ |
| 8: | 10.4x | ↘ |
| 9: | 10.1 | ↗ |
| 10: | 10.7x | ↓ |

Serie **91**

Total **0**

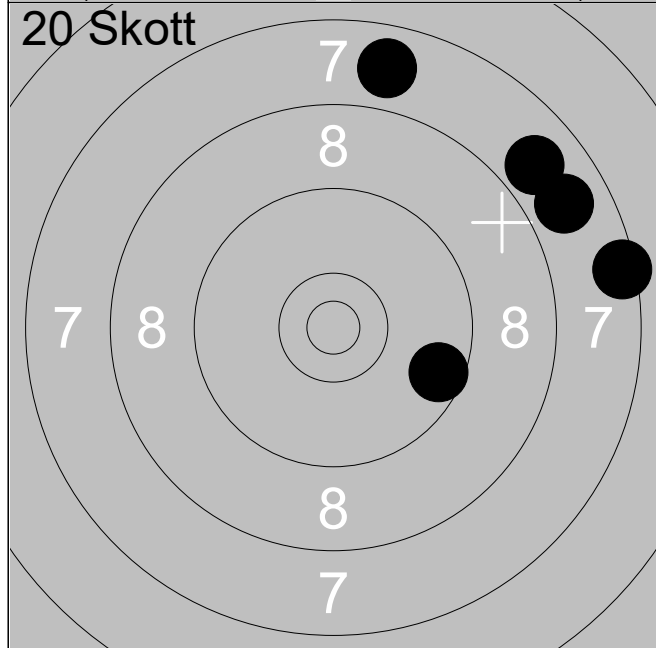

| | | |
|----|-----|---|
| 1: | 7.5 | → |
| 2: | 7.8 | ↑ |
| 3: | 7.9 | ↗ |
| 4: | 7.8 | ↗ |
| 5: | 9.6 | → |

Serie **37**

Total **37**

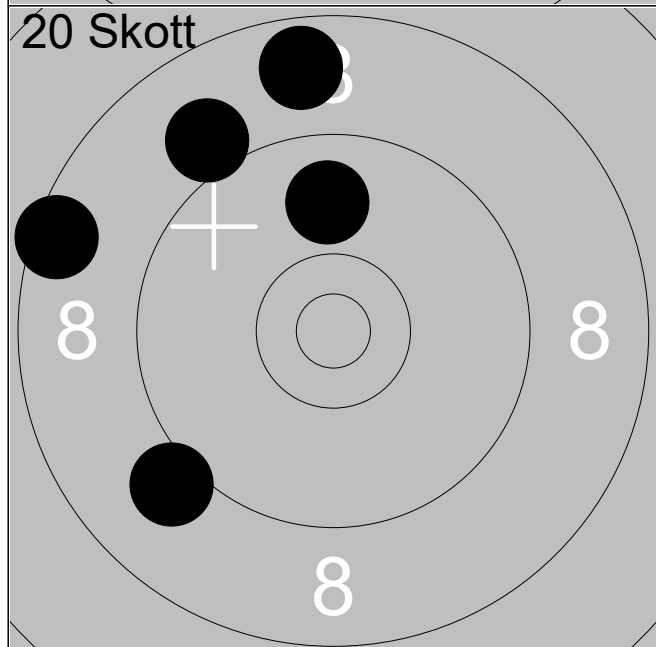

| | | |
|-----|-----|---|
| 6: | 9.0 | ↗ |
| 7: | 8.5 | ← |
| 8: | 9.9 | ↑ |
| 9: | 9.1 | ↙ |
| 10: | 8.7 | ↑ |

Serie **43**

Total **80**

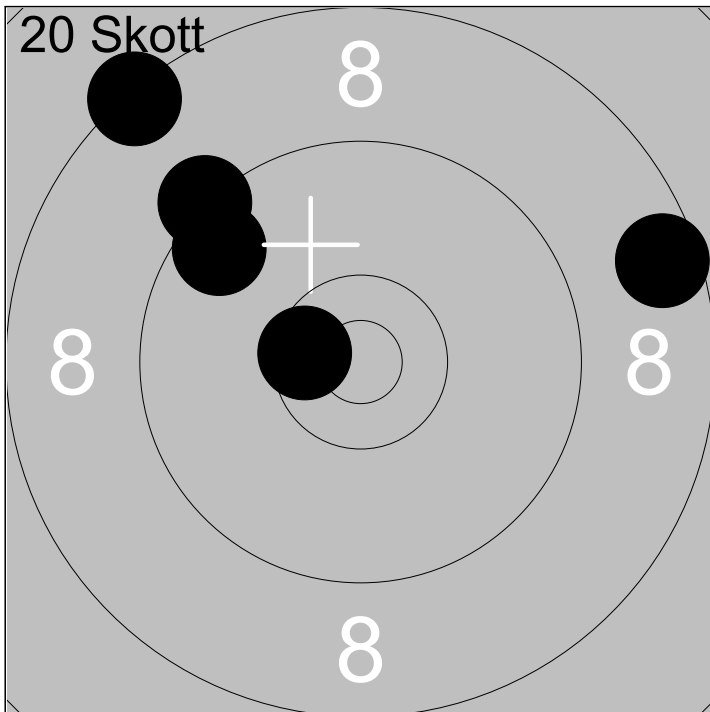

| | | |
|-----|-------|---|
| 11: | 8.6 | → |
| 12: | 9.3 | ↗ |
| 13: | 8.4 | ↗ |
| 14: | 9.6 | ↗ |
| 15: | 10.5x | ← |

Serie 44

Total 124

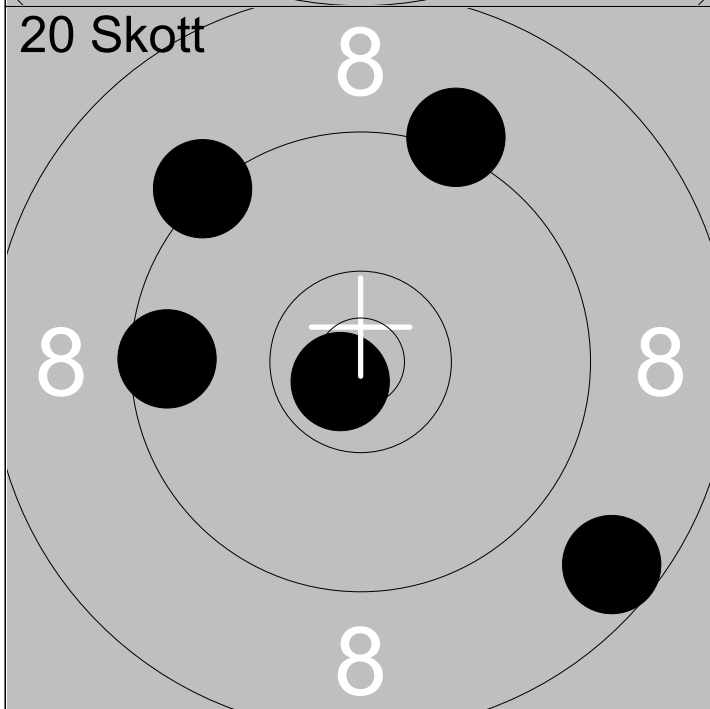

| | | |
|-----|-------|---|
| 16: | 8.6 | ↘ |
| 17: | 9.2 | ↗ |
| 18: | 9.3 | ↗ |
| 19: | 9.6 | ← |
| 20: | 10.7x | ↘ |

Serie 45

Total 169

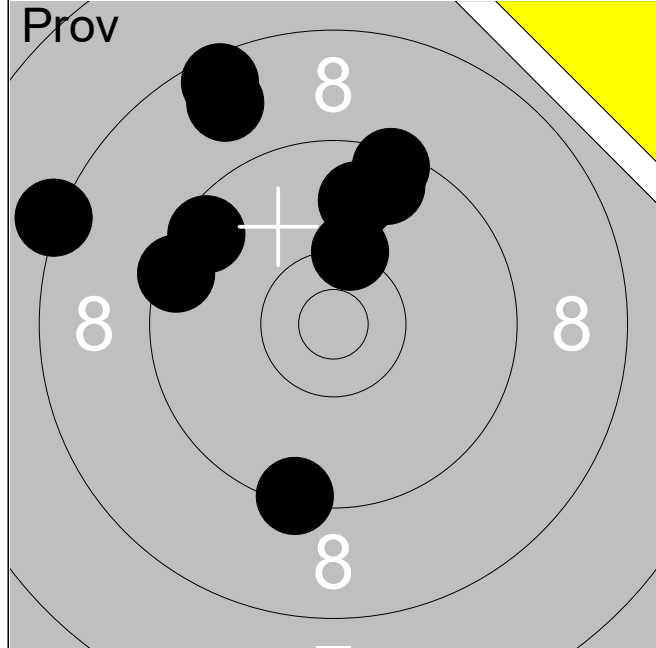

| | | |
|-----|------|---|
| 1: | 9.4 | ↓ |
| 2: | 10.3 | ↑ |
| 3: | 9.5 | ← |
| 4: | 8.5 | ↗ |
| 5: | 8.3 | ← |
| 6: | 9.5 | ↗ |
| 7: | 9.6 | ↑ |
| 8: | 9.4 | ↑ |
| 9: | 9.8 | ↑ |
| 10: | 8.7 | ↖ |

| | |
|-------|-----------|
| Serie | 88 |
|-------|-----------|

| | |
|-------|----------|
| Total | 0 |
|-------|----------|

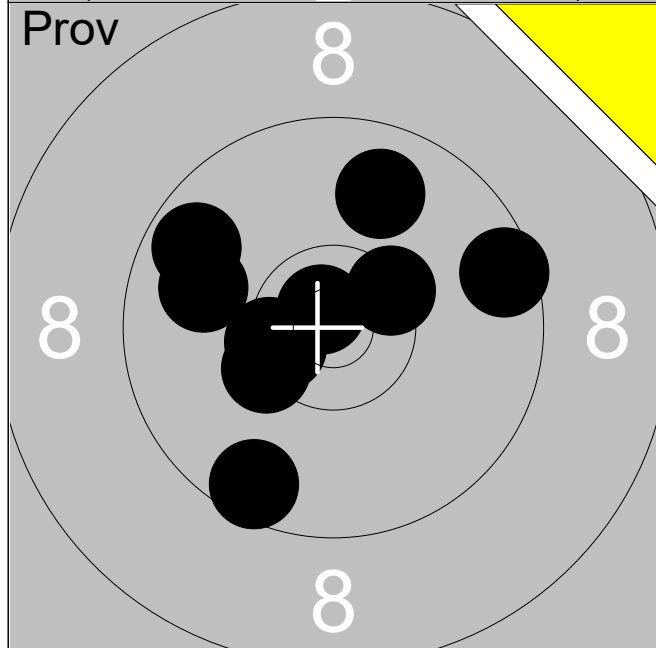

| | | |
|-----|-------|---|
| 11: | 10.8x | ↖ |
| 12: | 9.9 | ← |
| 13: | 9.8 | ↑ |
| 14: | 9.6 | ↓ |
| 15: | 10.3x | ← |
| 16: | 9.7 | ↖ |
| 17: | 10.4x | ← |
| 18: | 9.5 | → |
| 19: | 10.5x | ← |
| 20: | 10.4x | ↗ |

| | |
|-------|-----------|
| Serie | 95 |
|-------|-----------|

| | |
|-------|----------|
| Total | 0 |
|-------|----------|

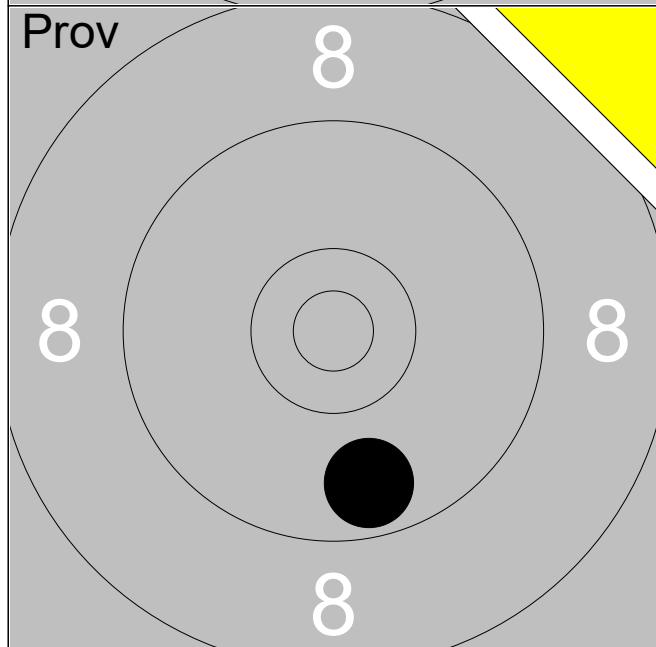

| | | |
|-----|-----|---|
| 21: | 9.7 | ↓ |
|-----|-----|---|

| | |
|-------|----------|
| Serie | 9 |
|-------|----------|

| | |
|-------|----------|
| Total | 0 |
|-------|----------|

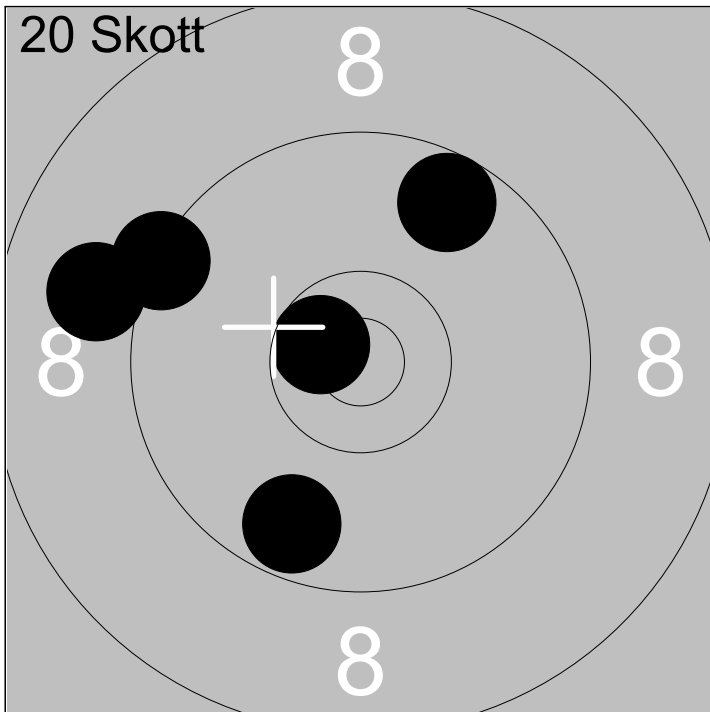

| | | |
|----|-------|---|
| 1: | 9.7 | ↘ |
| 2: | 10.6x | ↖ |
| 3: | 9.3 | ↗ |
| 4: | 9.0 | ↖ |
| 5: | 9.7 | ↗ |

Serie 46

Total 46

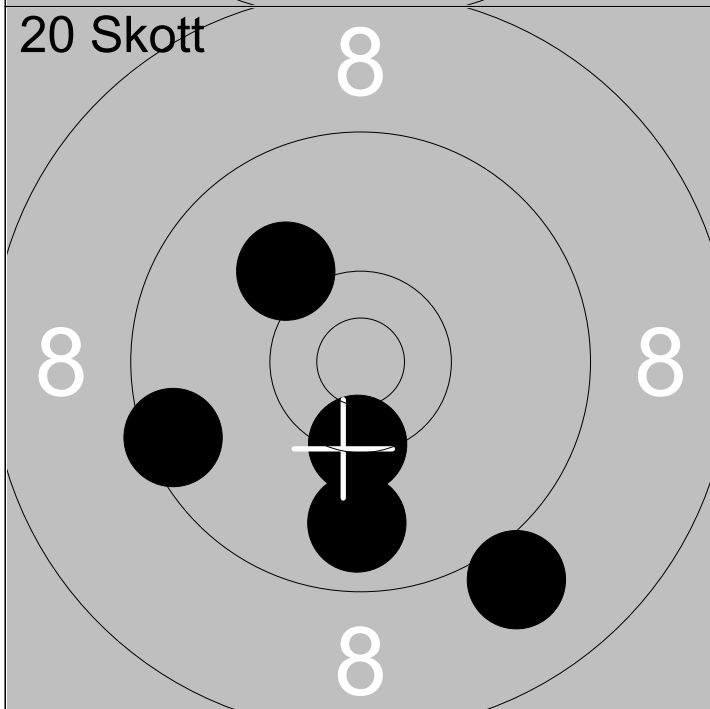

| | | |
|-----|-------|---|
| 6: | 9.8 | ↓ |
| 7: | 10.4x | ↓ |
| 8: | 10.1 | ↗ |
| 9: | 9.5 | ↖ |
| 10: | 9.0 | ↘ |

Serie 47

Total 93

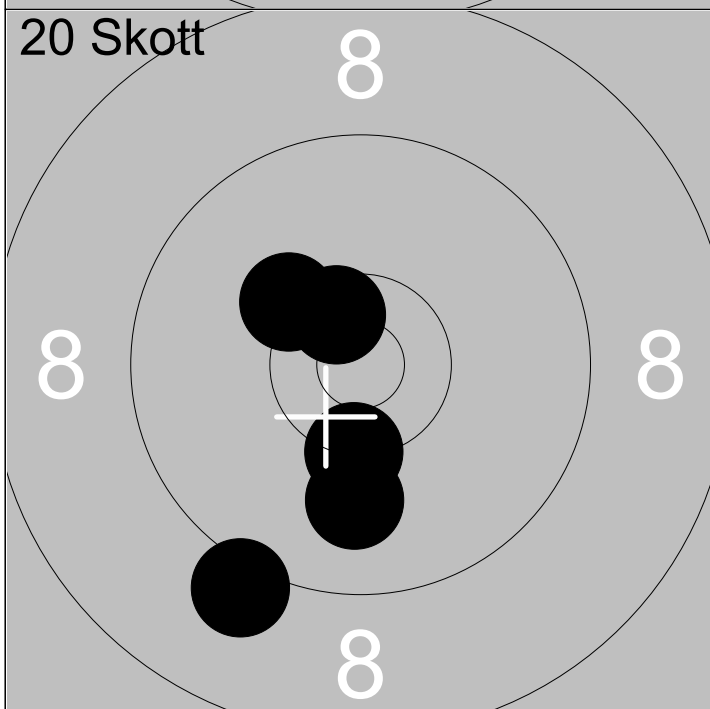

| | | |
|-----|-------|---|
| 11: | 10.3x | ↓ |
| 12: | 10.0 | ↓ |
| 13: | 10.6x | ↗ |
| 14: | 9.1 | ↘ |
| 15: | 10.3 | ↗ |

Serie 49

Total 142

20 Skott

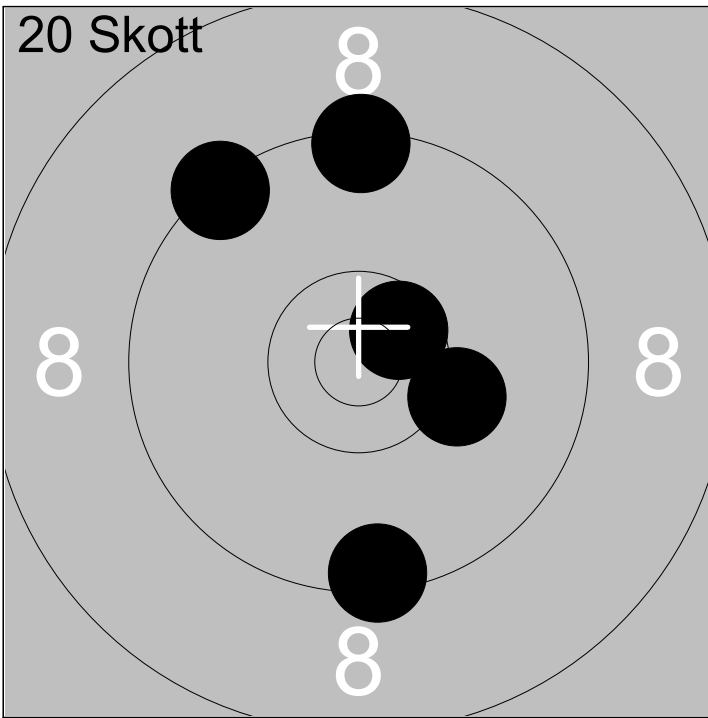

| | | |
|-----|-------|---|
| 16: | 9.4 | ↖ |
| 17: | 10.6x | ↗ |
| 18: | 10.2 | → |
| 19: | 9.4 | ↓ |
| 20: | 9.4 | ↑ |

| | |
|-------|-----|
| Serie | 47 |
| Total | 189 |

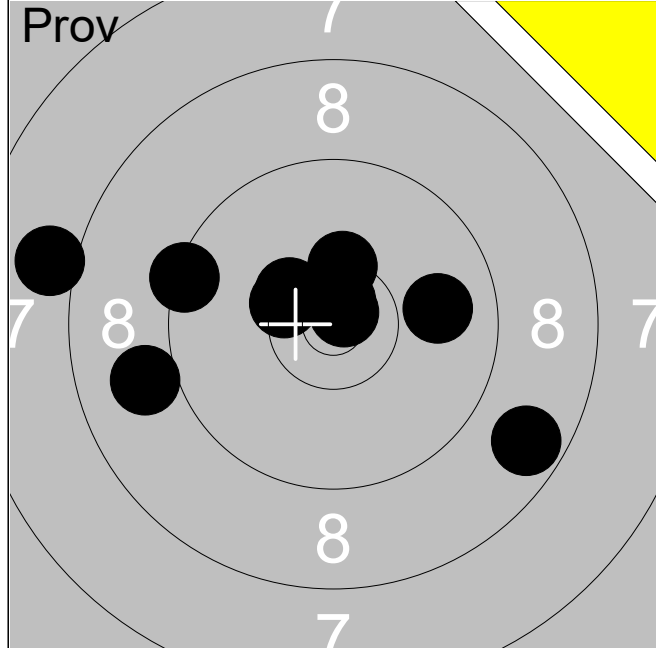

| | | |
|-----|-------|---|
| 1: | 8.7 | ↘ |
| 2: | 9.0 | ← |
| 3: | 8.0 | ← |
| 4: | 10.4x | ↗ |
| 5: | 10.4x | ← |
| 6: | 10.7x | ↑ |
| 7: | 10.4x | ↑ |
| 8: | 9.9 | → |
| 9: | 9.4 | ← |
| 10: | 10.8x | ↗ |

| | |
|-------|-----------|
| Serie | 93 |
|-------|-----------|

| | |
|-------|----------|
| Total | 0 |
|-------|----------|

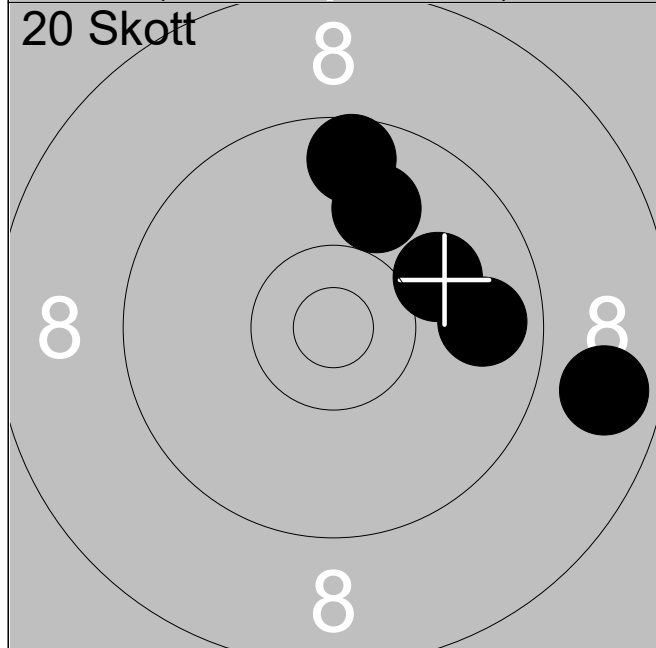

| | | |
|----|------|---|
| 1: | 10.0 | ↗ |
| 2: | 9.6 | ↑ |
| 3: | 10.0 | ↑ |
| 4: | 9.8 | → |
| 5: | 8.8 | → |

| | |
|-------|-----------|
| Serie | 46 |
|-------|-----------|

| | |
|-------|-----------|
| Total | 46 |
|-------|-----------|

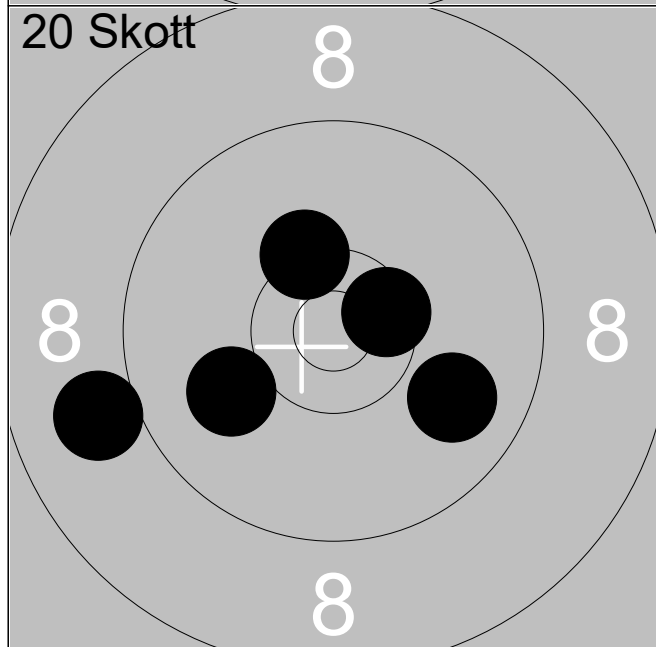

| | | |
|-----|-------|---|
| 6: | 9.9 | ↘ |
| 7: | 10.5x | → |
| 8: | 9.0 | ← |
| 9: | 10.0 | ← |
| 10: | 10.3x | ↑ |

| | |
|-------|-----------|
| Serie | 48 |
|-------|-----------|

| | |
|-------|-----------|
| Total | 94 |
|-------|-----------|

20 Skott

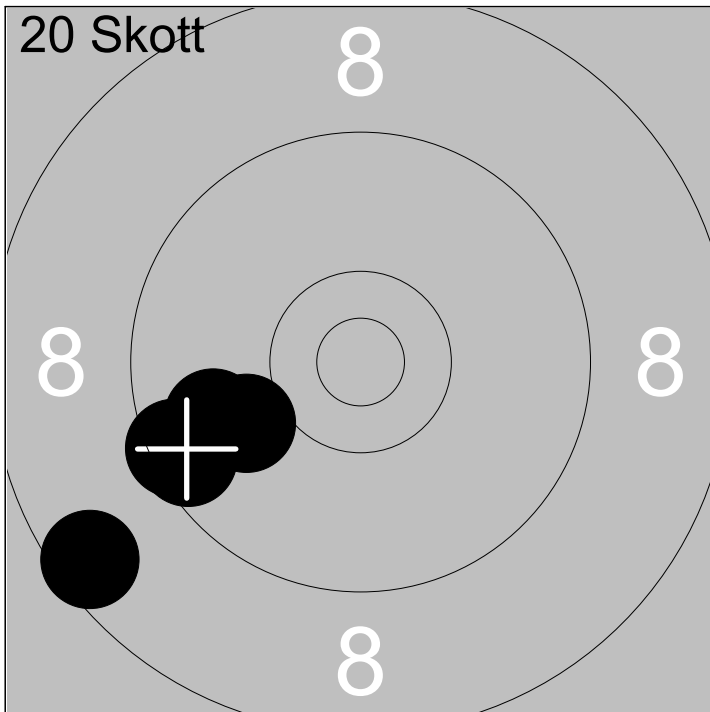

| | | |
|-----|------|---|
| 11: | 9.5 | ↙ |
| 12: | 9.5 | ↙ |
| 13: | 8.5 | ↙ |
| 14: | 10.0 | ↙ |
| 15: | 9.8 | ↙ |

Serie 45

Total 139

20 Skott

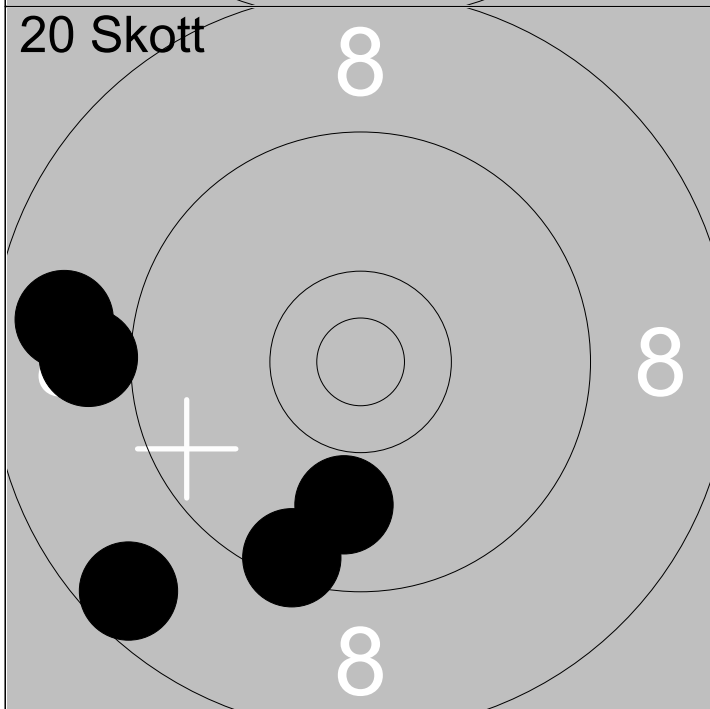

| | | |
|-----|-----|---|
| 16: | 8.8 | ↙ |
| 17: | 9.5 | ↓ |
| 18: | 9.0 | ↙ |
| 19: | 8.6 | ↙ |
| 20: | 9.9 | ↓ |

Serie 43

Total 182

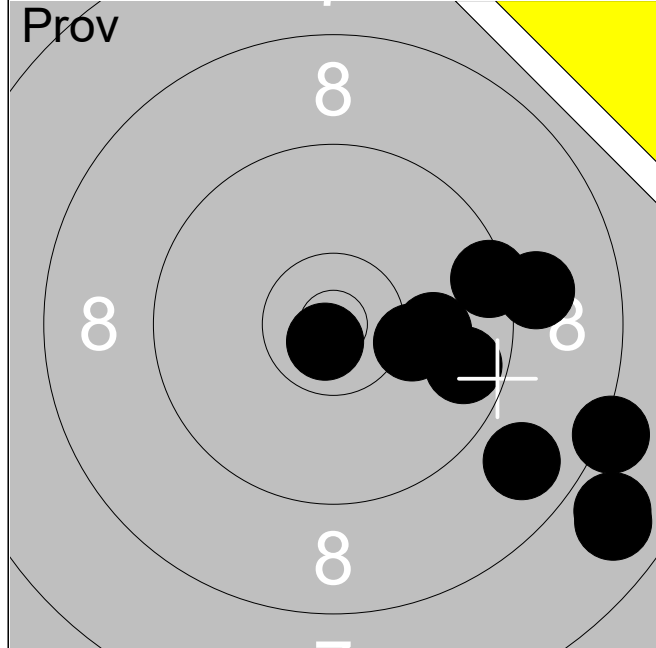

| | | |
|-----|-------|---|
| 1: | 7.9 | ↘ |
| 2: | 7.8 | ↘ |
| 3: | 10.8x | ↙ |
| 4: | 10.2 | → |
| 5: | 9.1 | → |
| 6: | 8.8 | ↘ |
| 7: | 9.7 | → |
| 8: | 8.2 | ↘ |
| 9: | 10.0 | → |
| 10: | 9.5 | → |

| | |
|-------|----|
| Serie | 87 |
|-------|----|

| | |
|-------|---|
| Total | 0 |
|-------|---|

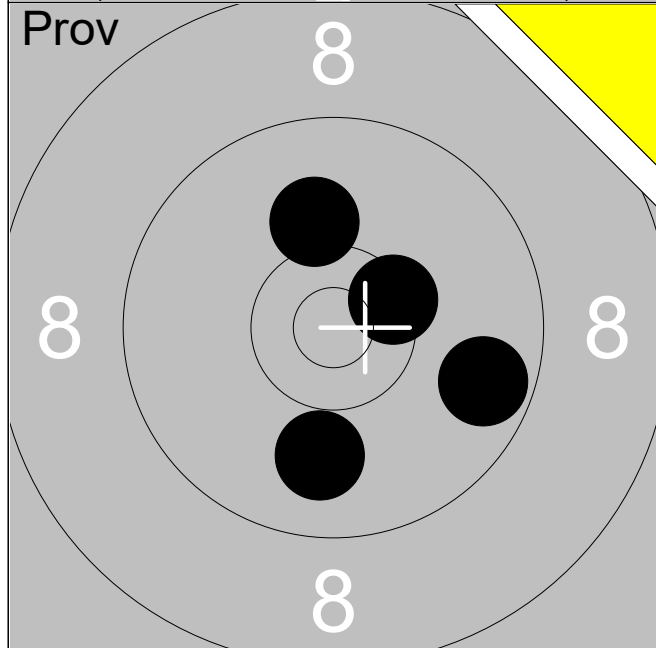

| | | |
|-----|-------|---|
| 11: | 9.7 | → |
| 12: | 10.4x | → |
| 13: | 10.1 | ↑ |
| 14: | 9.9 | ↓ |

| | |
|-------|----|
| Serie | 38 |
|-------|----|

| | |
|-------|---|
| Total | 0 |
|-------|---|

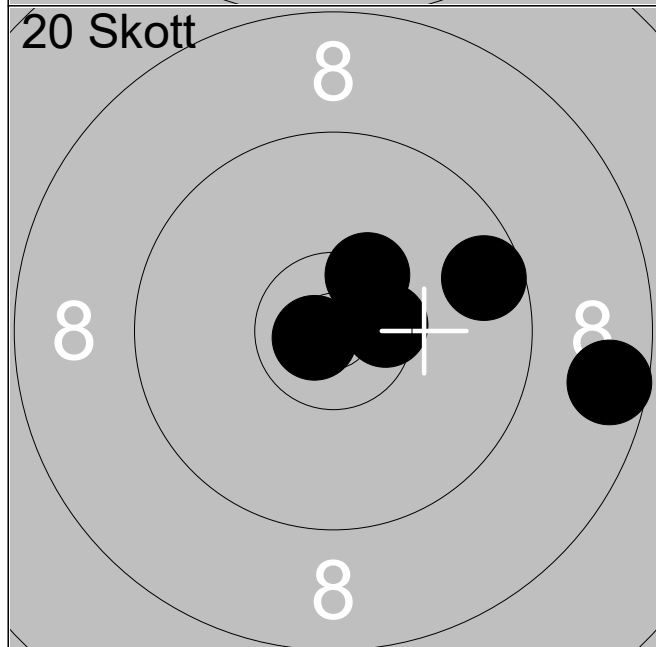

| | | |
|----|-------|---|
| 1: | 9.6 | → |
| 2: | 10.4x | ↗ |
| 3: | 10.8x | ← |
| 4: | 8.6 | → |
| 5: | 10.5x | → |

| | |
|-------|----|
| Serie | 47 |
|-------|----|

| | |
|-------|----|
| Total | 47 |
|-------|----|

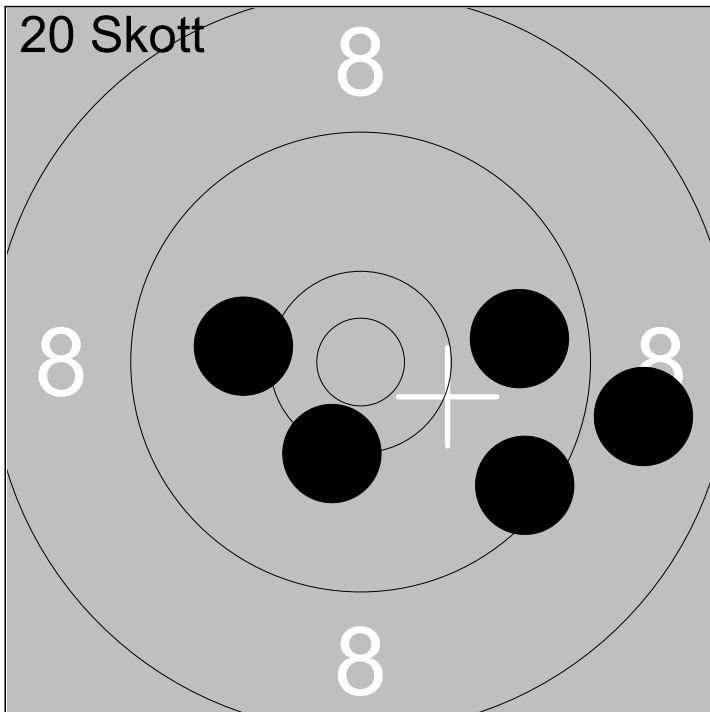

| | | |
|-----|------|---|
| 6: | 8.9 | → |
| 7: | 9.5 | ↘ |
| 8: | 9.8 | → |
| 9: | 10.3 | ↘ |
| 10: | 10.1 | ← |

Serie 46

Total 93

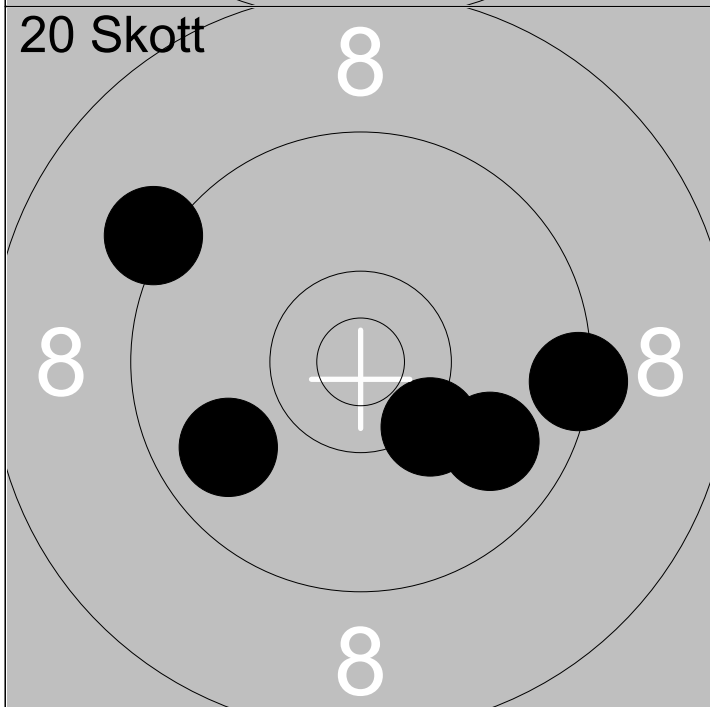

| | | |
|-----|------|---|
| 11: | 9.8 | ← |
| 12: | 9.2 | ↗ |
| 13: | 9.4 | → |
| 14: | 9.9 | ↘ |
| 15: | 10.3 | ↘ |

Serie 46

Total 139

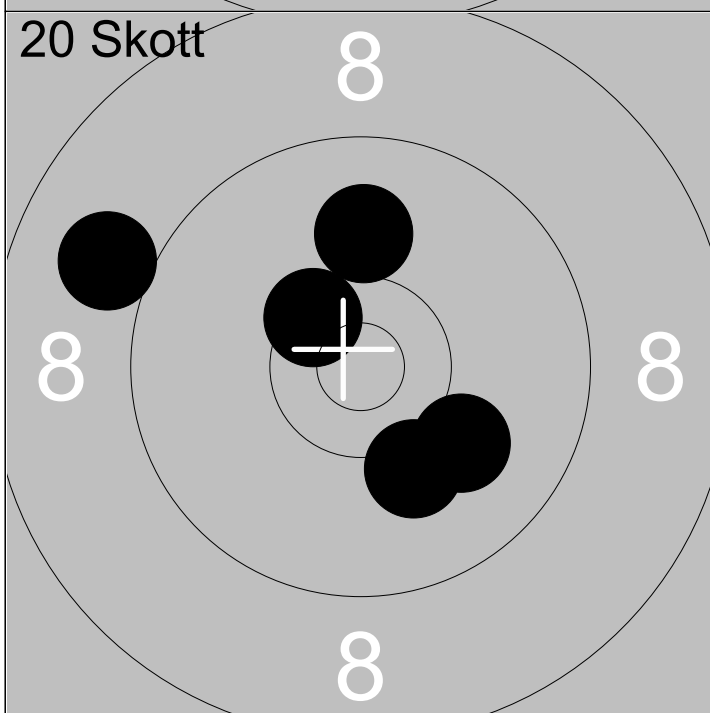

| | | |
|-----|-------|---|
| 16: | 9.0 | ← |
| 17: | 10.0 | ↘ |
| 18: | 10.0 | ↑ |
| 19: | 10.5x | ↗ |
| 20: | 10.1 | ↘ |

Serie 49

Total 188

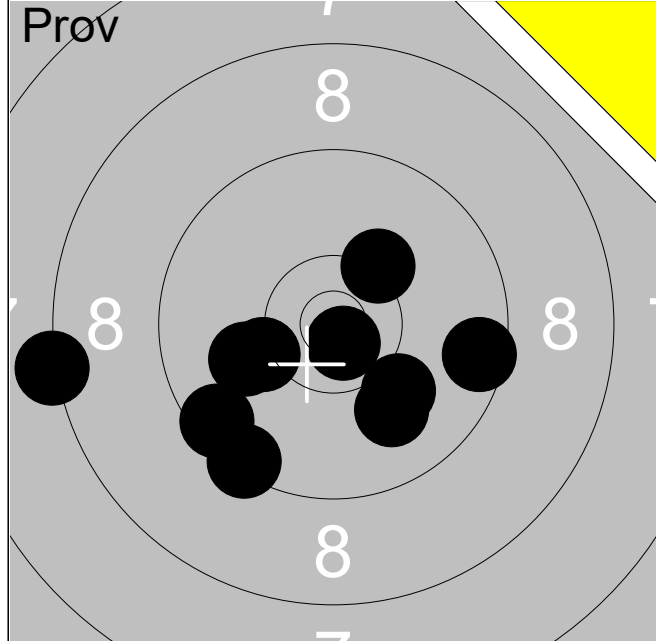

| | | |
|-----|-------|---|
| 1: | 10.1 | ↘ |
| 2: | 10.2 | ← |
| 3: | 9.4 | ↘ |
| 4: | 10.1 | ← |
| 5: | 10.3 | ↗ |
| 6: | 10.7x | ↘ |
| 7: | 9.5 | → |
| 8: | 10.0 | ↘ |
| 9: | 9.5 | ↙ |
| 10: | 8.3 | ← |

| | |
|-------|-----------|
| Serie | 95 |
|-------|-----------|

| | |
|-------|----------|
| Total | 0 |
|-------|----------|

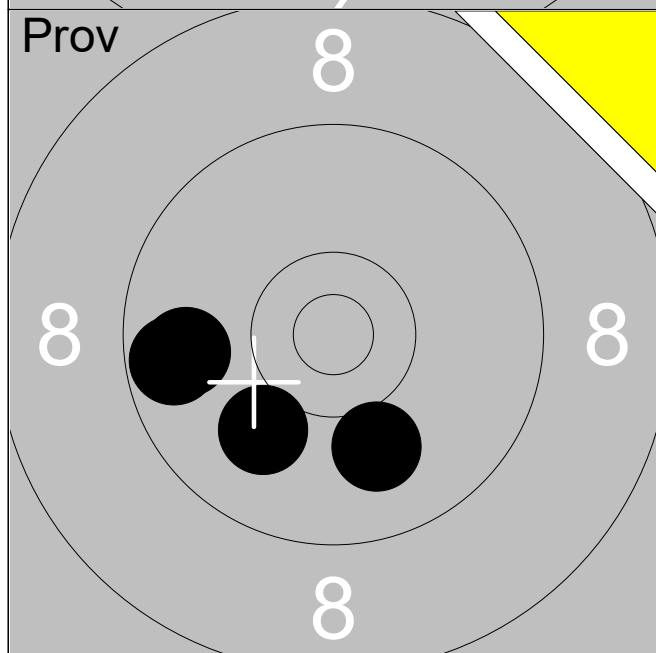

| | | |
|-----|------|---|
| 11: | 10.0 | ↘ |
| 12: | 9.7 | ← |
| 13: | 9.8 | ← |
| 14: | 10.0 | ↘ |

| | |
|-------|-----------|
| Serie | 38 |
|-------|-----------|

| | |
|-------|----------|
| Total | 0 |
|-------|----------|

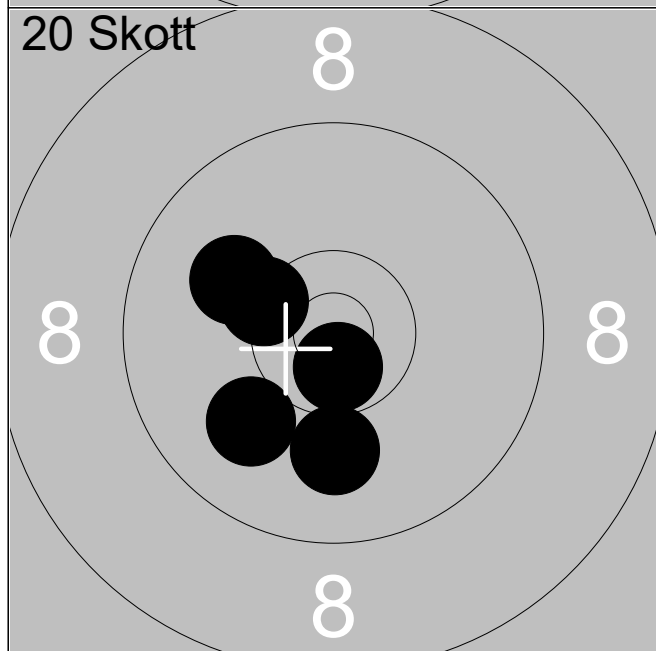

| | | |
|----|-------|---|
| 1: | 10.7x | ↘ |
| 2: | 10.0 | ↘ |
| 3: | 10.0 | ↘ |
| 4: | 10.4x | ↙ |
| 5: | 10.1 | ↙ |

| | |
|-------|-----------|
| Serie | 50 |
|-------|-----------|

| | |
|-------|-----------|
| Total | 50 |
|-------|-----------|

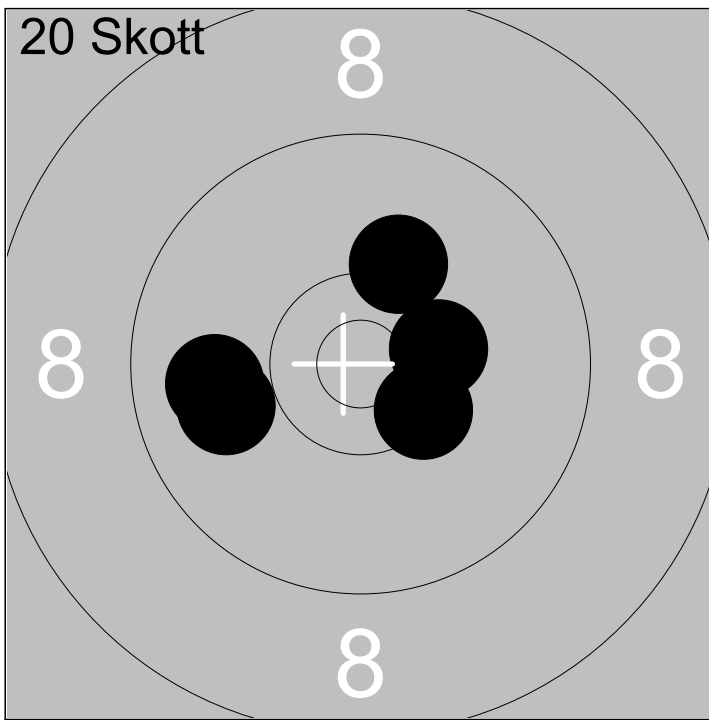

| | | |
|-----|-------|---|
| 6: | 9.9 | ← |
| 7: | 10.4x | ↘ |
| 8: | 10.2 | ↑ |
| 9: | 9.9 | ← |
| 10: | 10.4x | → |

| | |
|-------|----|
| Serie | 48 |
| Total | 98 |

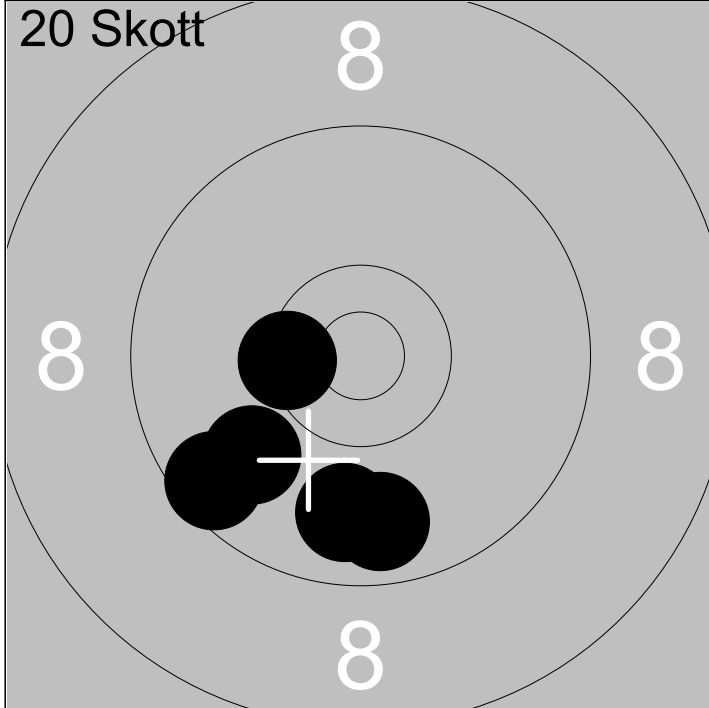

| | | |
|-----|-------|---|
| 11: | 9.8 | ↓ |
| 12: | 10.4x | ← |
| 13: | 9.9 | ↙ |
| 14: | 9.8 | ↓ |
| 15: | 9.6 | ↙ |

| | |
|-------|-----|
| Serie | 46 |
| Total | 144 |

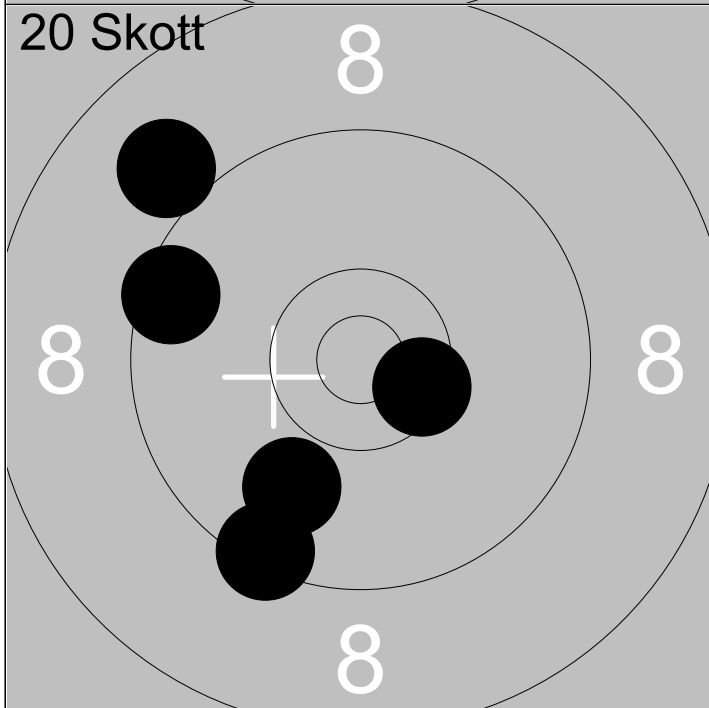

| | | |
|-----|-------|---|
| 16: | 9.9 | ↙ |
| 17: | 9.4 | ↙ |
| 18: | 9.0 | ↗ |
| 19: | 9.5 | ← |
| 20: | 10.5x | ↘ |

| | |
|-------|-----|
| Serie | 46 |
| Total | 190 |

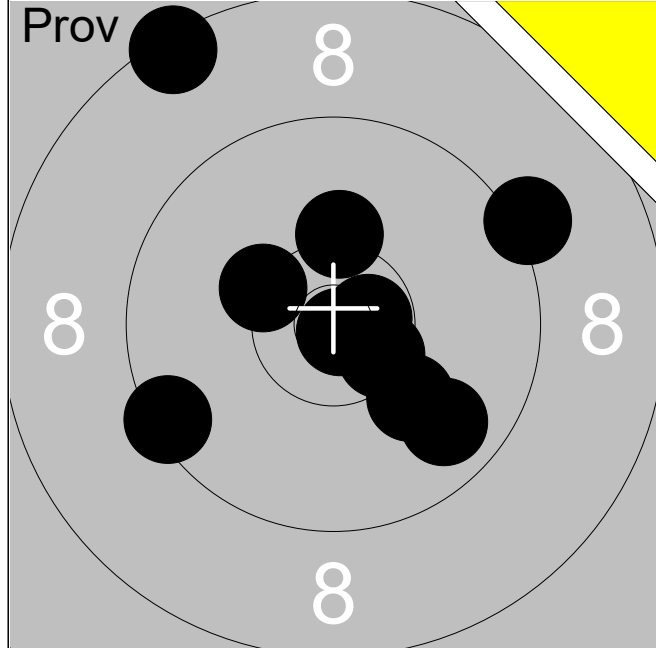

| | | |
|-----|-------|---|
| 1: | 8.4 | ↗ |
| 2: | 9.4 | ↖ |
| 3: | 10.7x | → |
| 4: | 10.9x | ↘ |
| 5: | 9.8 | ↘ |
| 6: | 10.1 | ↘ |
| 7: | 10.5x | ↘ |
| 8: | 10.3x | ↗ |
| 9: | 9.2 | ↗ |
| 10: | 10.2 | ↑ |

| | |
|-------|-----------|
| Serie | 95 |
|-------|-----------|

| | |
|-------|----------|
| Total | 0 |
|-------|----------|

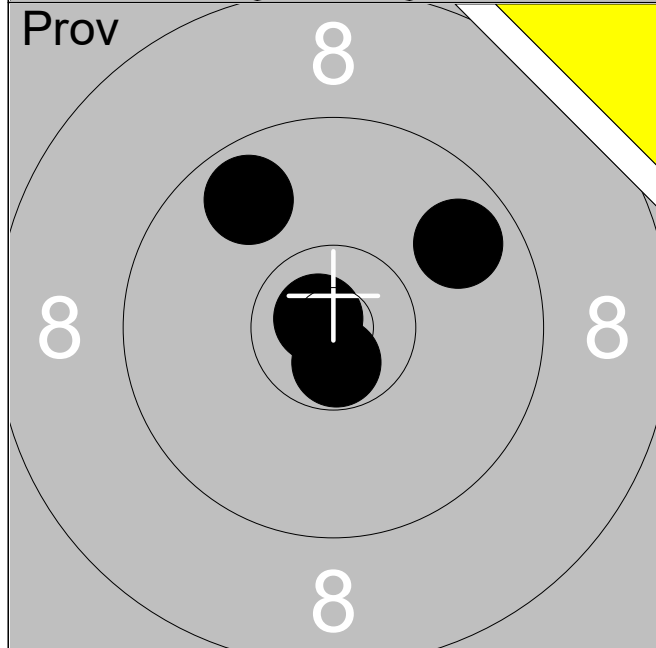

| | | |
|-----|-------|---|
| 11: | 9.7 | ↗ |
| 12: | 10.8x | ↖ |
| 13: | 10.7x | ↓ |
| 14: | 9.8 | ↗ |

| | |
|-------|-----------|
| Serie | 38 |
|-------|-----------|

| | |
|-------|----------|
| Total | 0 |
|-------|----------|

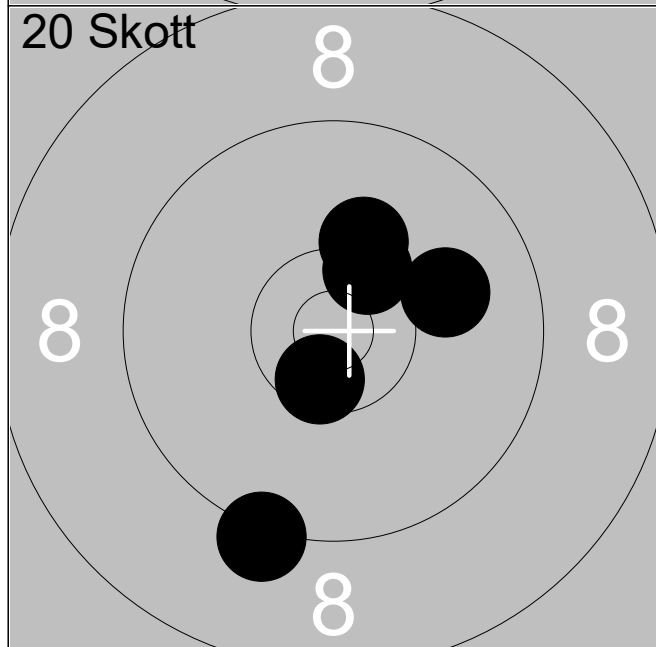

| | | |
|----|-------|---|
| 1: | 9.2 | ↘ |
| 2: | 10.6x | ↘ |
| 3: | 10.2 | ↗ |
| 4: | 10.4x | ↗ |
| 5: | 10.0 | → |

| | |
|-------|-----------|
| Serie | 49 |
|-------|-----------|

| | |
|-------|-----------|
| Total | 49 |
|-------|-----------|

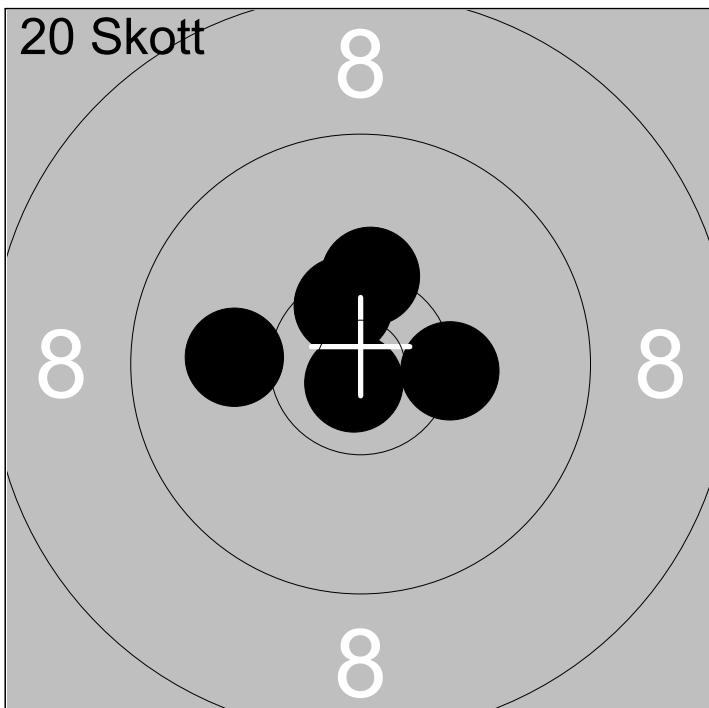

| | | |
|-----|-------|---|
| 6: | 10.3x | ↑ |
| 7: | 10.3x | → |
| 8: | 10.0 | ← |
| 9: | 10.8x | ↓ |
| 10: | 10.5x | ↑ |

| | |
|-------|----|
| Serie | 50 |
| Total | 99 |

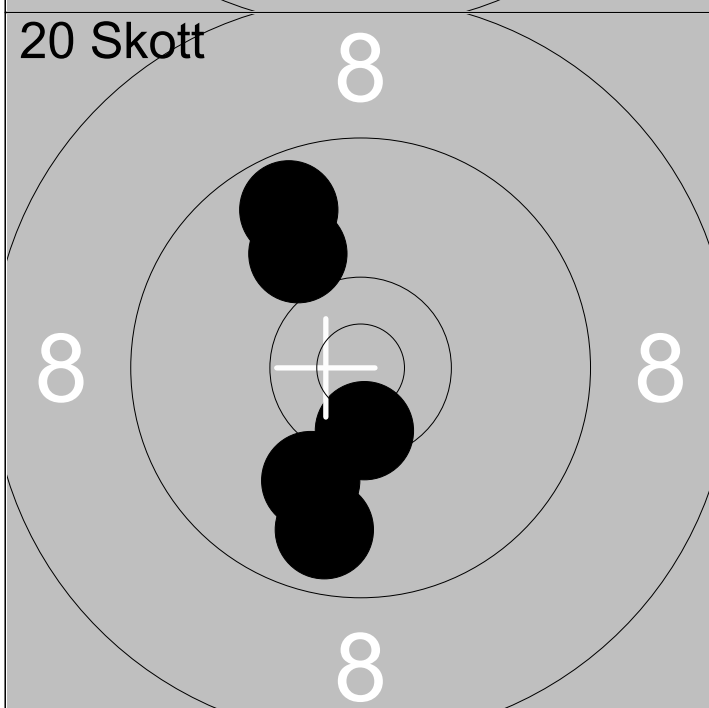

| | | |
|-----|-------|---|
| 11: | 9.8 | ↓ |
| 12: | 10.5x | ↓ |
| 13: | 9.7 | ↗ |
| 14: | 10.0 | ↗ |
| 15: | 10.1 | ↓ |

| | |
|-------|-----|
| Serie | 48 |
| Total | 147 |

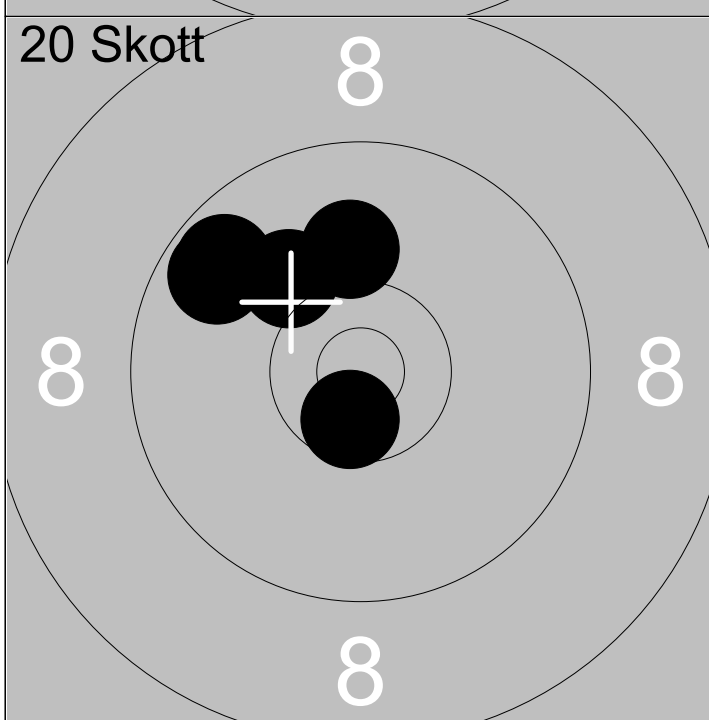

| | | |
|-----|-------|---|
| 16: | 9.7 | ↖ |
| 17: | 10.1 | ↗ |
| 18: | 9.7 | ↗ |
| 19: | 10.1 | ↑ |
| 20: | 10.6x | ↓ |

| | |
|-------|-----|
| Serie | 48 |
| Total | 195 |

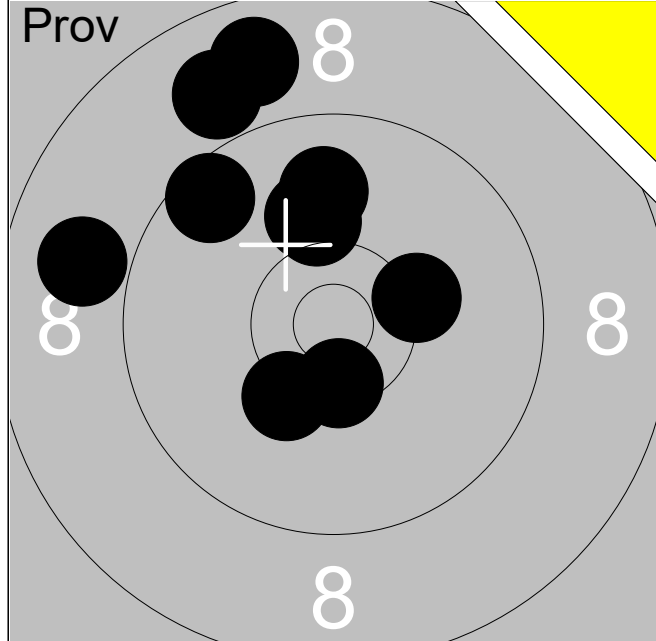

| | | |
|-----|-------|---|
| 1: | 10.5x | ↓ |
| 2: | 10.1 | ↑ |
| 3: | 8.8 | ↑ |
| 4: | 9.6 | ↗ |
| 5: | 10.3 | → |
| 6: | 10.1 | ↑ |
| 7: | 9.9 | ↑ |
| 8: | 8.9 | ↗ |
| 9: | 8.9 | ← |
| 10: | 10.3 | ↘ |

| | |
|-------|-----------|
| Serie | 92 |
|-------|-----------|

| | |
|-------|----------|
| Total | 0 |
|-------|----------|

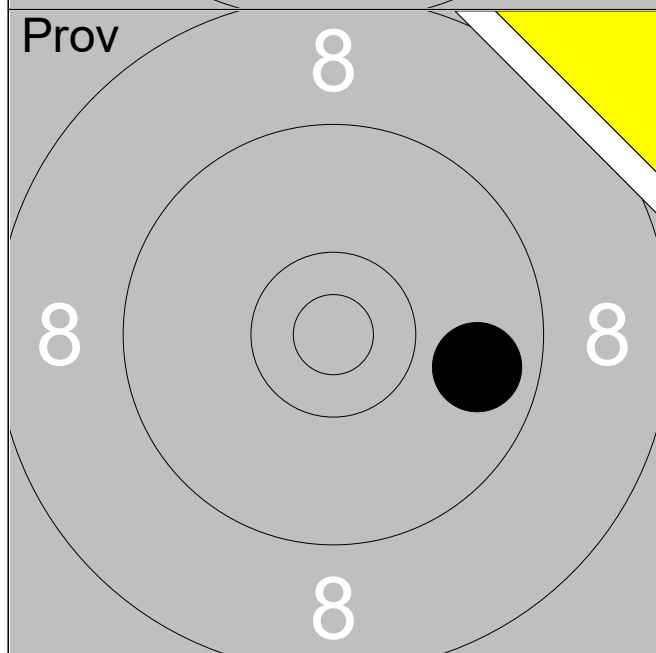

| | | |
|-----|-----|---|
| 11: | 9.8 | → |
|-----|-----|---|

| | |
|-------|----------|
| Serie | 9 |
|-------|----------|

| | |
|-------|----------|
| Total | 0 |
|-------|----------|

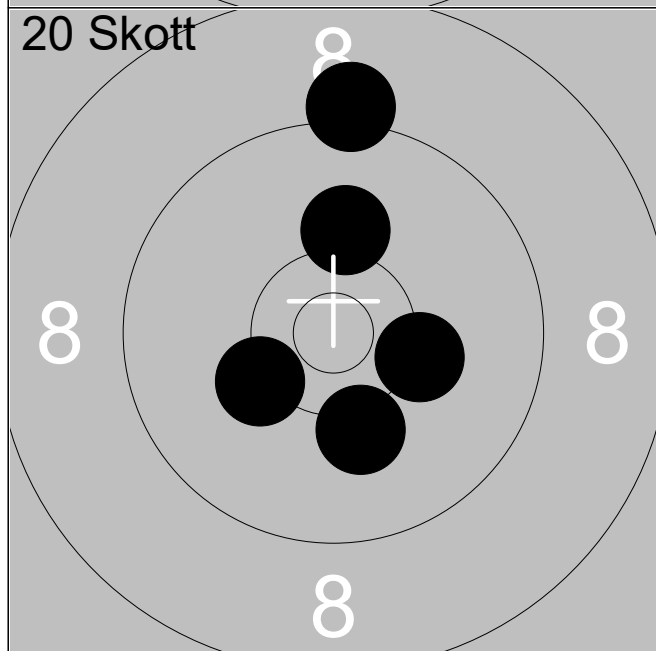

| | | |
|----|------|---|
| 1: | 10.2 | ↘ |
| 2: | 10.3 | ↙ |
| 3: | 10.1 | ↑ |
| 4: | 9.2 | ↑ |
| 5: | 10.2 | → |

| | |
|-------|-----------|
| Serie | 49 |
|-------|-----------|

| | |
|-------|-----------|
| Total | 49 |
|-------|-----------|

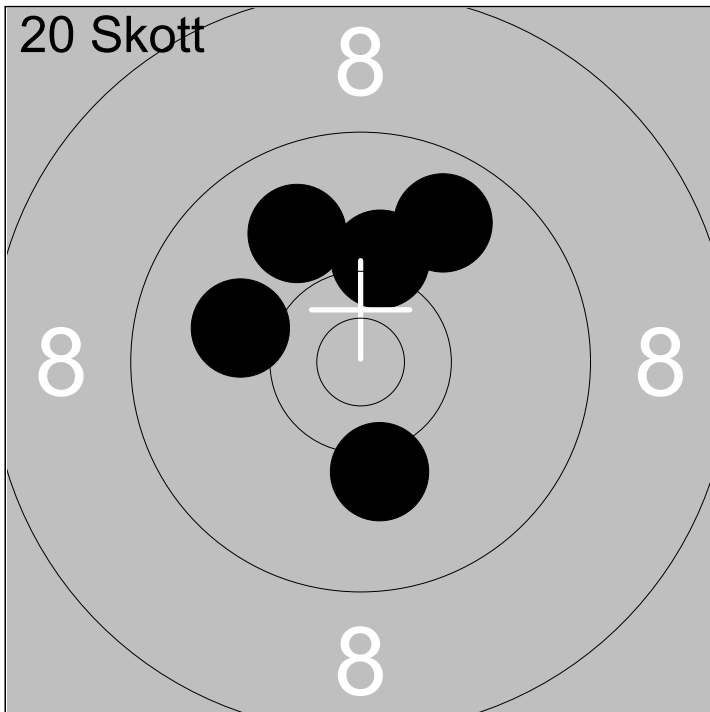

| | | |
|-----|------|---|
| 6: | 10.1 | ← |
| 7: | 9.8 | ↗ |
| 8: | 9.9 | ↗ |
| 9: | 10.2 | ↓ |
| 10: | 10.2 | ↑ |

Serie 48

Total 97

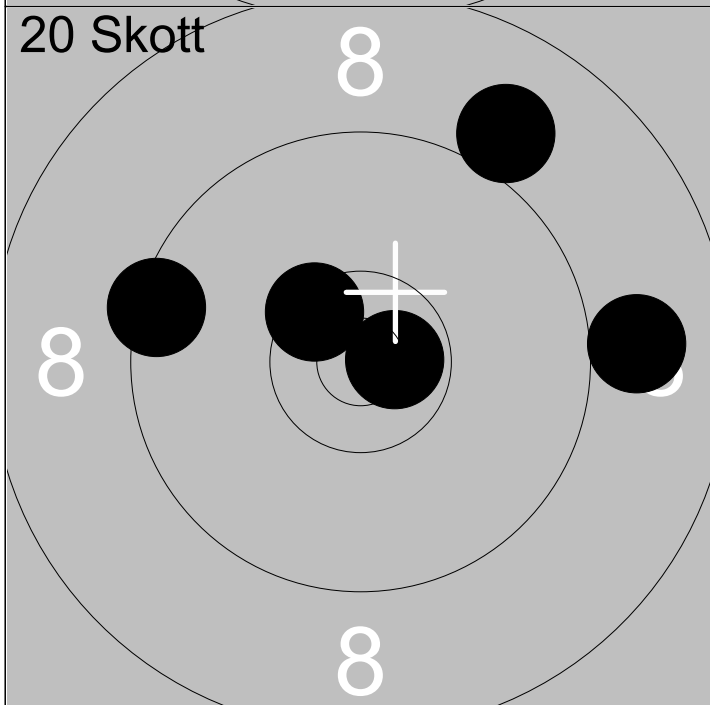

| | | |
|-----|-------|---|
| 11: | 9.0 | ↗ |
| 12: | 10.7x | → |
| 13: | 9.0 | → |
| 14: | 9.4 | ← |
| 15: | 10.5x | ↗ |

Serie 47

Total 144

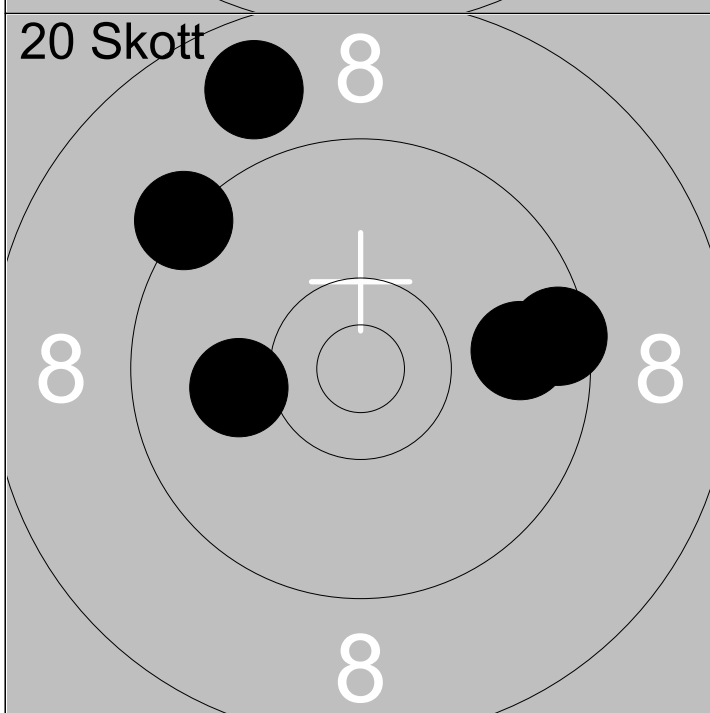

| | | |
|-----|------|---|
| 16: | 9.3 | ↖ |
| 17: | 9.5 | → |
| 18: | 8.8 | ↗ |
| 19: | 9.8 | → |
| 20: | 10.1 | ← |

Serie 45

Total 189

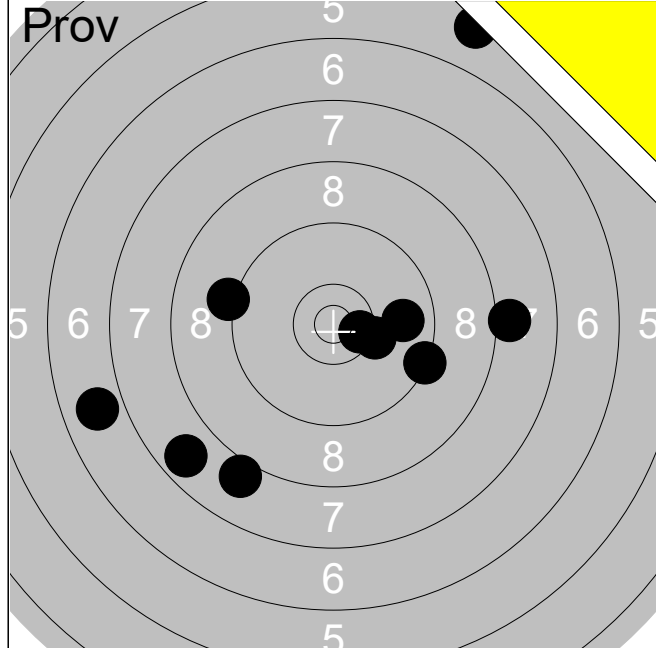

| | | |
|-----|-------|---|
| 1: | 5.6 | ↗ |
| 2: | 6.9 | ↖ |
| 3: | 7.7 | ↙ |
| 4: | 8.0 | ↓ |
| 5: | 9.2 | ↖ |
| 6: | 10.5x | → |
| 7: | 8.1 | → |
| 8: | 9.3 | ↘ |
| 9: | 9.8 | → |
| 10: | 10.2 | ↘ |

| | |
|-------|-----------|
| Serie | 81 |
|-------|-----------|

| | |
|-------|----------|
| Total | 0 |
|-------|----------|

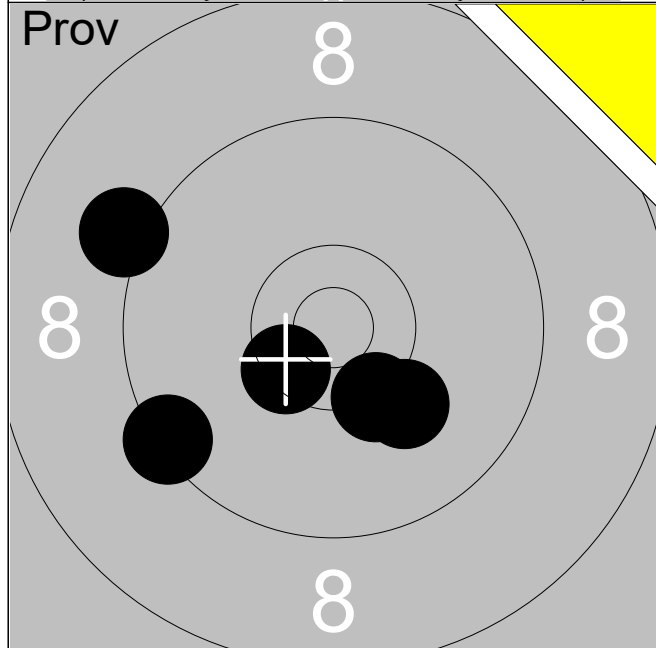

| | | |
|-----|-------|---|
| 11: | 10.5x | ↙ |
| 12: | 9.1 | ↖ |
| 13: | 9.4 | ↙ |
| 14: | 10.3x | ↓ |
| 15: | 10.1 | ↘ |

| | |
|-------|-----------|
| Serie | 48 |
|-------|-----------|

| | |
|-------|----------|
| Total | 0 |
|-------|----------|

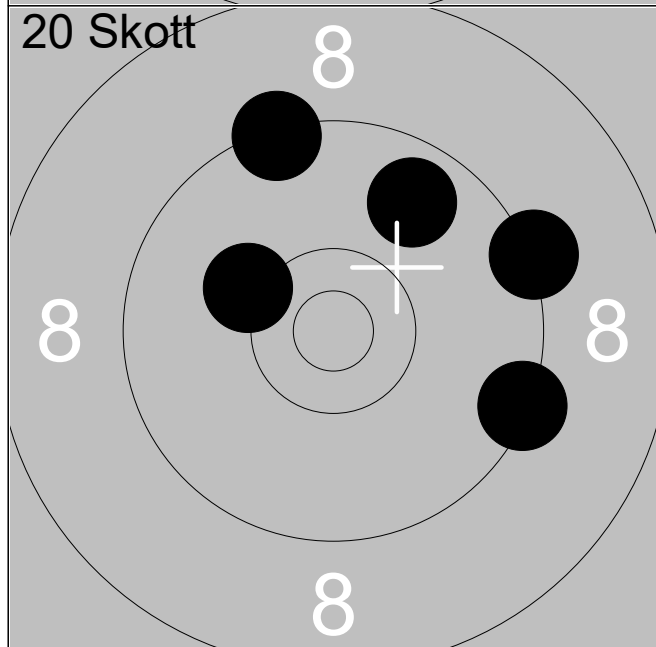

| | | |
|----|------|---|
| 1: | 9.8 | ↗ |
| 2: | 10.2 | ↖ |
| 3: | 9.4 | ↗ |
| 4: | 9.3 | → |
| 5: | 9.4 | ↘ |

| | |
|-------|-----------|
| Serie | 46 |
|-------|-----------|

| | |
|-------|-----------|
| Total | 46 |
|-------|-----------|

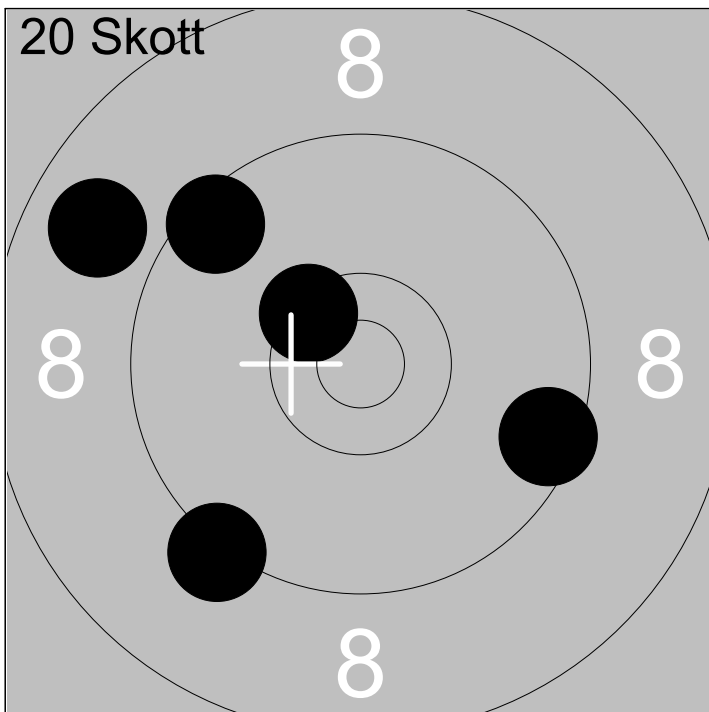

| | | |
|-----|-------|---|
| 6: | 10.4x | ↗ |
| 7: | 9.5 | ↘ |
| 8: | 9.2 | ↙ |
| 9: | 8.8 | ↖ |
| 10: | 9.5 | ↗ |

| | |
|-------|----|
| Serie | 45 |
| Total | 91 |

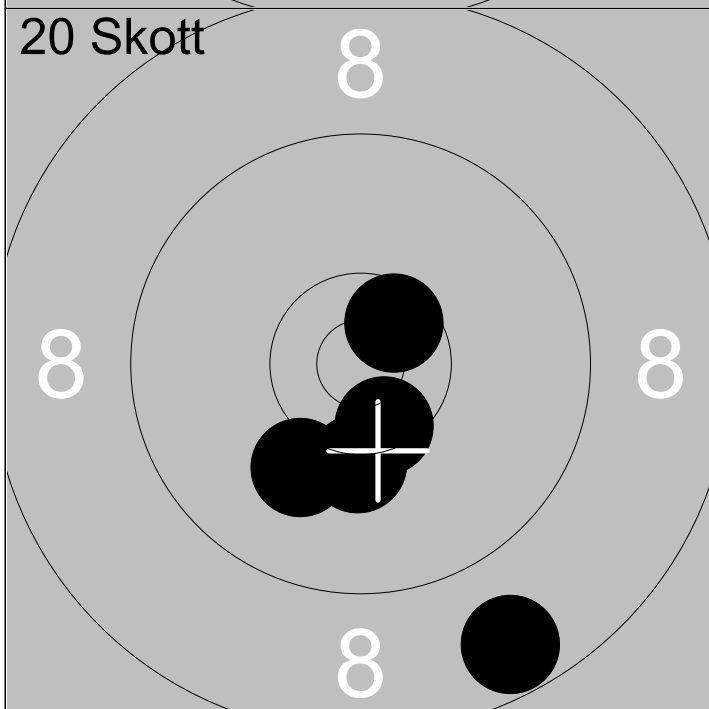

| | | |
|-----|-------|---|
| 11: | 10.1 | ↙ |
| 12: | 10.5x | ↘ |
| 13: | 10.6x | ↗ |
| 14: | 8.7 | ↘ |
| 15: | 10.2 | ↓ |

| | |
|-------|-----|
| Serie | 48 |
| Total | 139 |

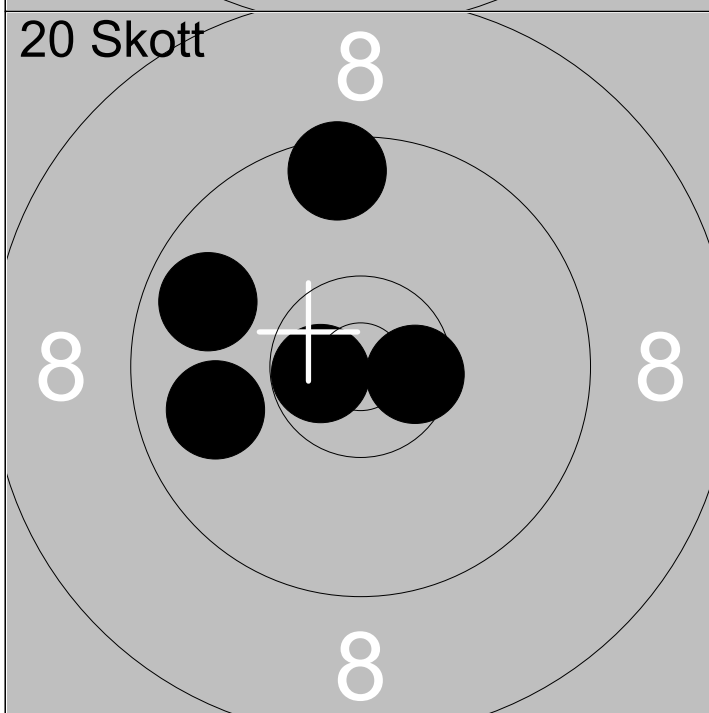

| | | |
|-----|-------|---|
| 16: | 10.6x | → |
| 17: | 9.8 | ↖ |
| 18: | 10.7x | ← |
| 19: | 9.5 | ↑ |
| 20: | 9.9 | ← |

| | |
|-------|-----|
| Serie | 47 |
| Total | 186 |

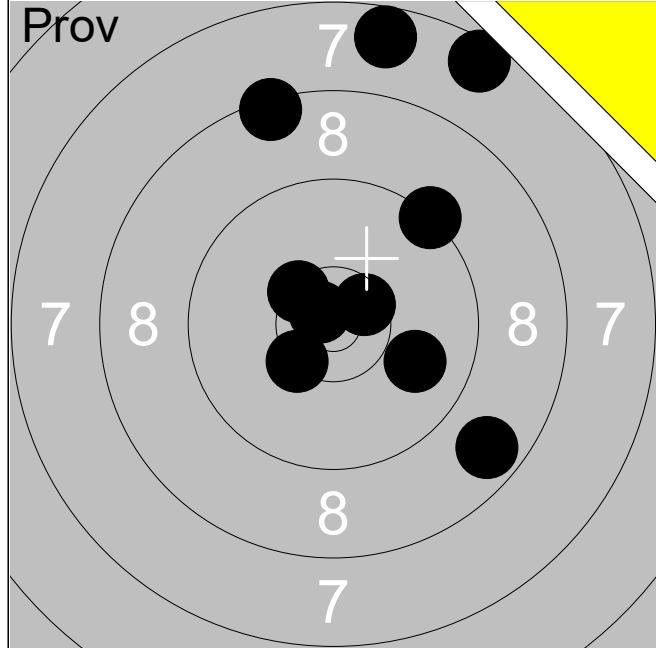

| | | |
|-----|-------|---|
| 1: | 7.5 | ↗ |
| 2: | 7.6 | ↑ |
| 3: | 10.4x | ↙ |
| 4: | 10.7x | ↗ |
| 5: | 10.4x | ↗ |
| 6: | 9.3 | ↗ |
| 7: | 9.9 | → |
| 8: | 10.5x | ↗ |
| 9: | 8.7 | ↙ |
| 10: | 8.4 | ↑ |

| | |
|-------|-----------|
| Serie | 88 |
|-------|-----------|

| | |
|-------|----------|
| Total | 0 |
|-------|----------|

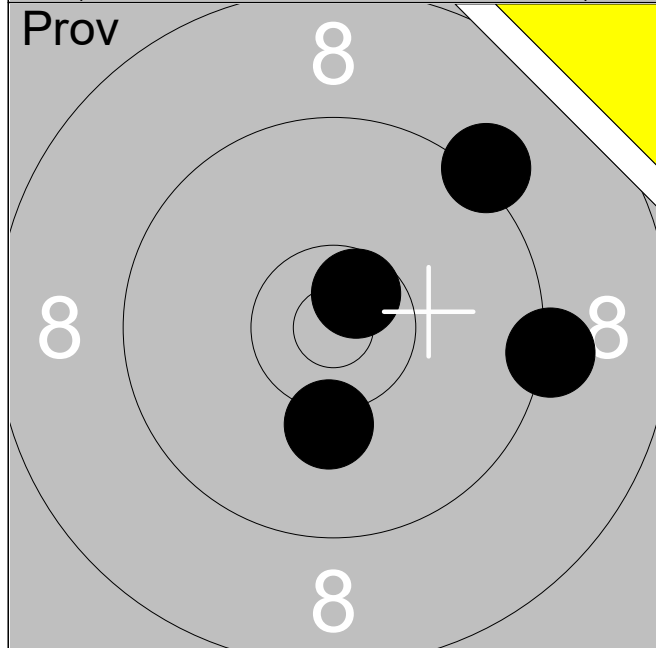

| | | |
|-----|-------|---|
| 11: | 10.6x | ↗ |
| 12: | 10.2 | ↓ |
| 13: | 9.2 | → |
| 14: | 9.2 | ↗ |

| | |
|-------|-----------|
| Serie | 38 |
|-------|-----------|

| | |
|-------|----------|
| Total | 0 |
|-------|----------|

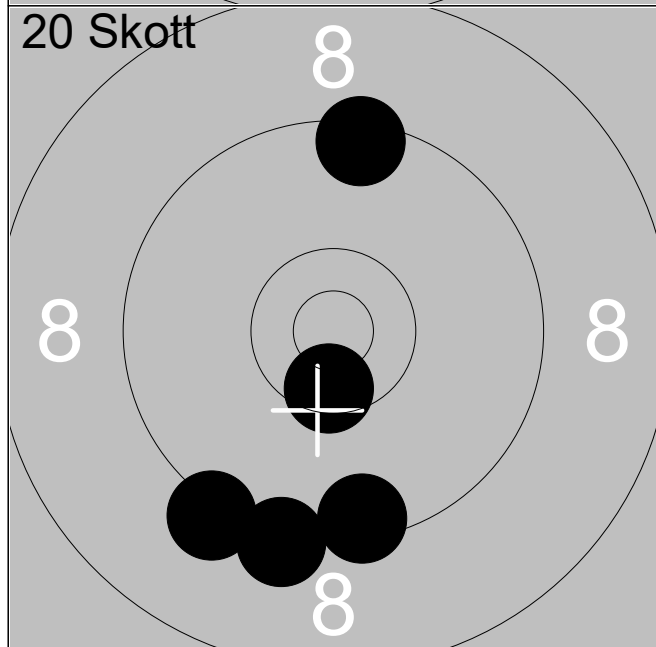

| | | |
|----|-------|---|
| 1: | 9.4 | ↑ |
| 2: | 9.2 | ↓ |
| 3: | 9.5 | ↓ |
| 4: | 10.5x | ↓ |
| 5: | 9.2 | ↙ |

| | |
|-------|-----------|
| Serie | 46 |
|-------|-----------|

| | |
|-------|-----------|
| Total | 46 |
|-------|-----------|

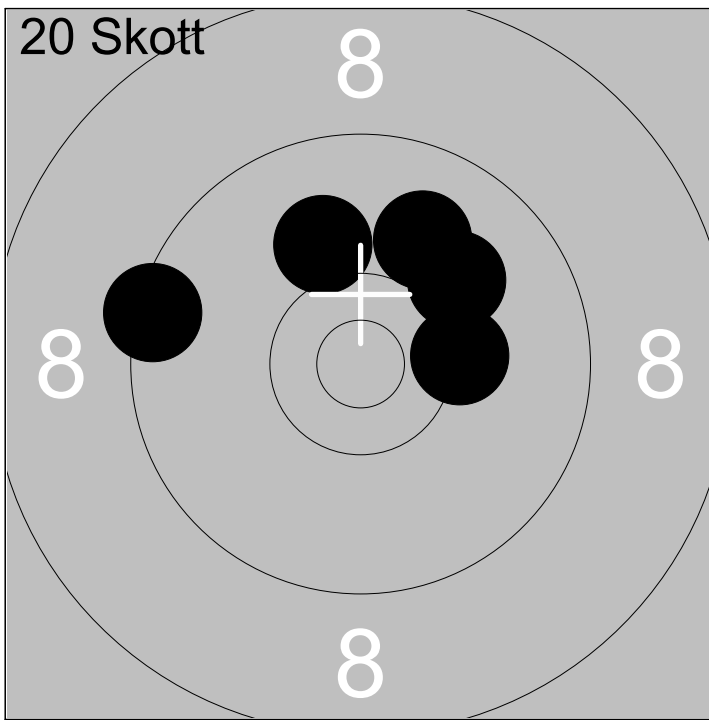

| | | |
|-----|------|---|
| 6: | 10.1 | ↖ |
| 7: | 10.2 | → |
| 8: | 9.4 | ↖ |
| 9: | 10.0 | ↗ |
| 10: | 10.0 | ↗ |

| | |
|-------|----|
| Serie | 49 |
| Total | 95 |

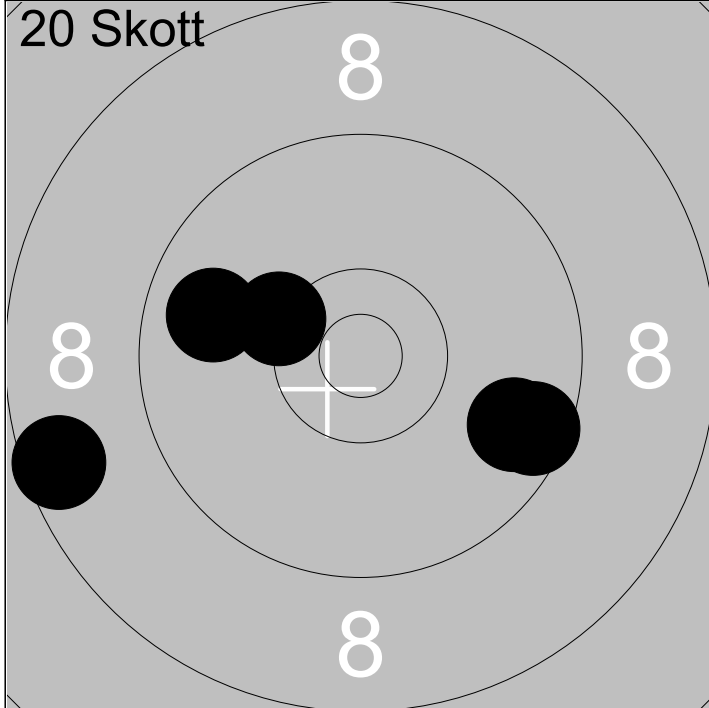

| | | |
|-----|------|---|
| 11: | 9.7 | ↘ |
| 12: | 9.6 | ↘ |
| 13: | 9.8 | ↖ |
| 14: | 8.6 | ↖ |
| 15: | 10.3 | ↖ |

| | |
|-------|-----|
| Serie | 45 |
| Total | 140 |

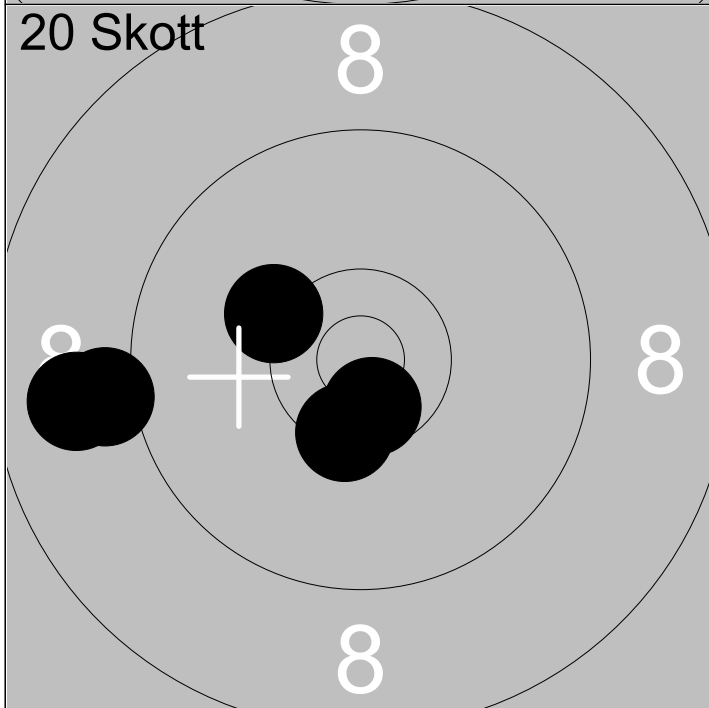

| | | |
|-----|-------|---|
| 16: | 10.6x | ↓ |
| 17: | 10.4x | ↓ |
| 18: | 8.9 | ↖ |
| 19: | 9.1 | ↖ |
| 20: | 10.2 | ↖ |

| | |
|-------|-----|
| Serie | 47 |
| Total | 187 |

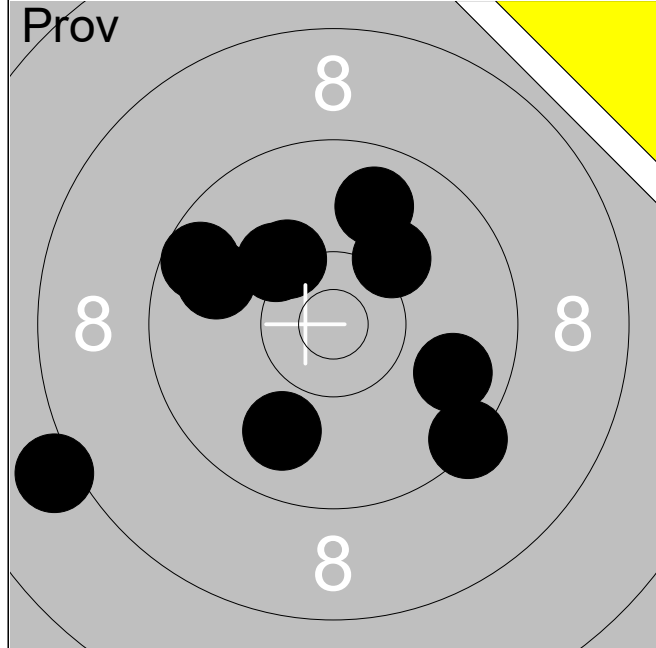

| | | |
|-----|------|---|
| 1: | 9.9 | ↘ |
| 2: | 8.1 | ← |
| 3: | 9.6 | ↗ |
| 4: | 9.8 | ↖ |
| 5: | 9.4 | ↘ |
| 6: | 10.2 | ↗ |
| 7: | 10.2 | ↗ |
| 8: | 9.8 | ↘ |
| 9: | 9.8 | ↗ |
| 10: | 10.2 | ↗ |

| | |
|-------|-----------|
| Serie | 92 |
|-------|-----------|

| | |
|-------|----------|
| Total | 0 |
|-------|----------|

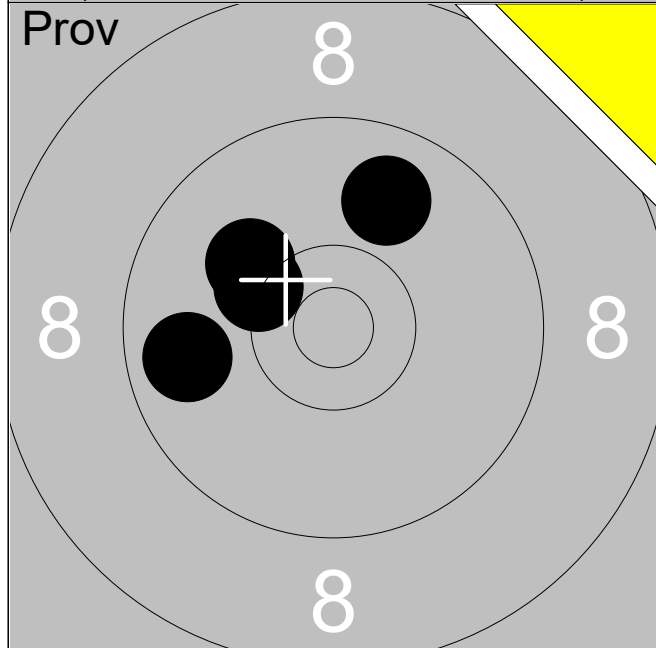

| | | |
|-----|------|---|
| 11: | 9.8 | ← |
| 12: | 10.1 | ↗ |
| 13: | 10.3 | ↗ |
| 14: | 9.9 | ↗ |

| | |
|-------|-----------|
| Serie | 38 |
|-------|-----------|

| | |
|-------|----------|
| Total | 0 |
|-------|----------|

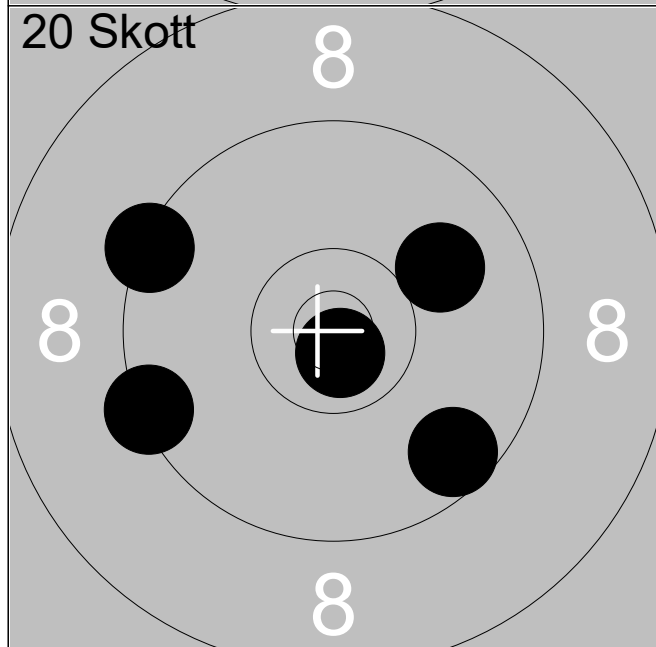

| | | |
|----|-------|---|
| 1: | 9.6 | ↘ |
| 2: | 9.4 | ↖ |
| 3: | 9.4 | ← |
| 4: | 10.0 | ↗ |
| 5: | 10.8x | ↘ |

| | |
|-------|-----------|
| Serie | 47 |
|-------|-----------|

| | |
|-------|-----------|
| Total | 47 |
|-------|-----------|

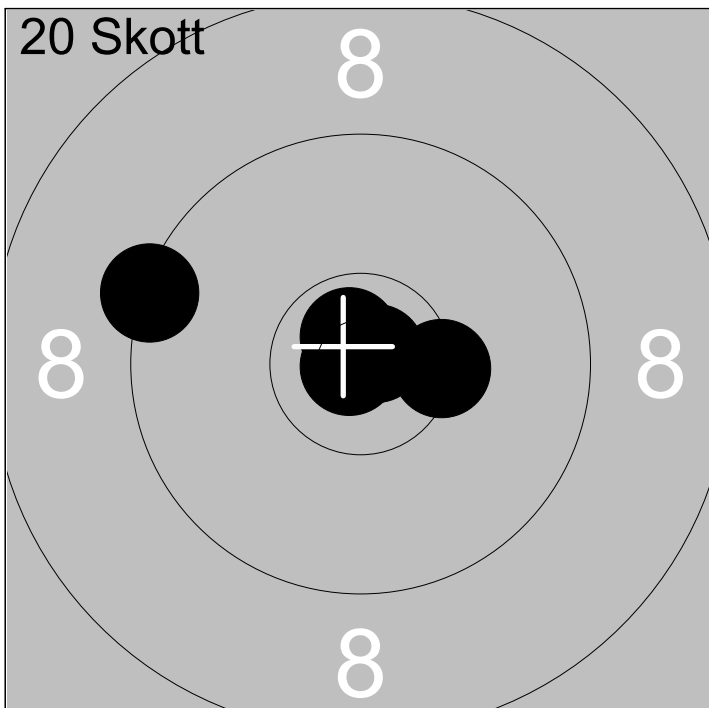

| | | |
|-----|-------|---|
| 6: | 10.7x | ↖ |
| 7: | 10.4x | → |
| 8: | 10.9x | ← |
| 9: | 10.8x | ↗ |
| 10: | 9.4 | ↖ |

| | |
|-------|----|
| Serie | 49 |
| Total | 96 |

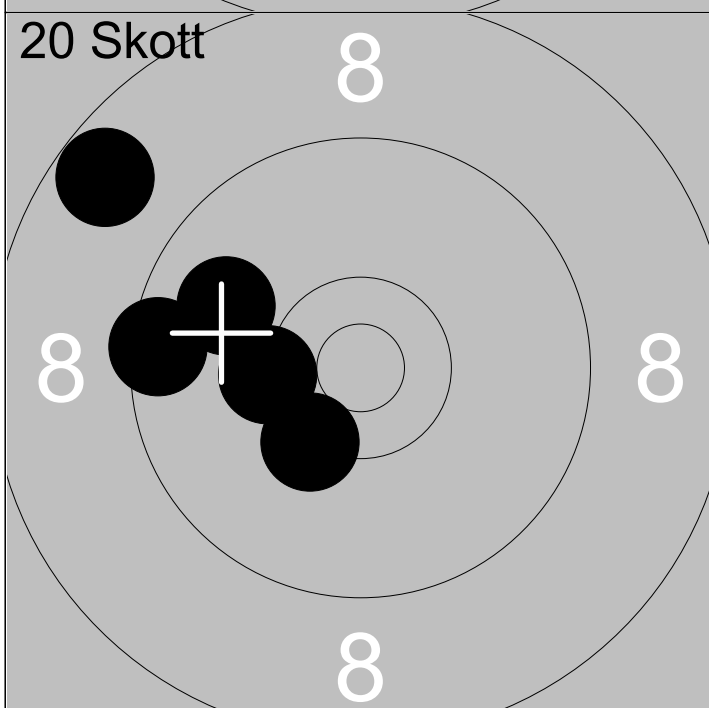

| | | |
|-----|-------|---|
| 11: | 10.3x | ↙ |
| 12: | 8.7 | ↗ |
| 13: | 9.5 | ← |
| 14: | 10.3 | ← |
| 15: | 9.9 | ↖ |

| | |
|-------|-----|
| Serie | 46 |
| Total | 142 |

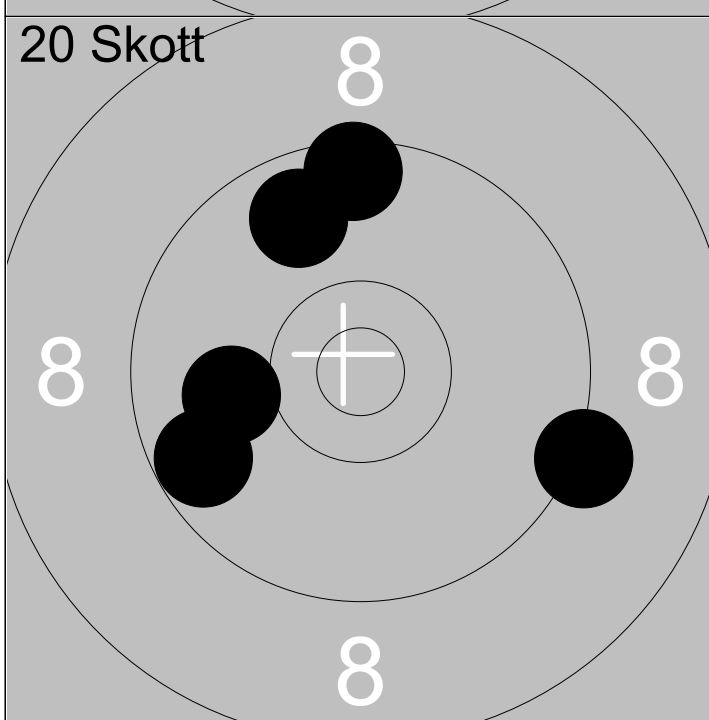

| | | |
|-----|------|---|
| 16: | 10.0 | ← |
| 17: | 9.2 | → |
| 18: | 9.8 | ↗ |
| 19: | 9.5 | ↑ |
| 20: | 9.7 | ↖ |

| | |
|-------|-----|
| Serie | 46 |
| Total | 188 |

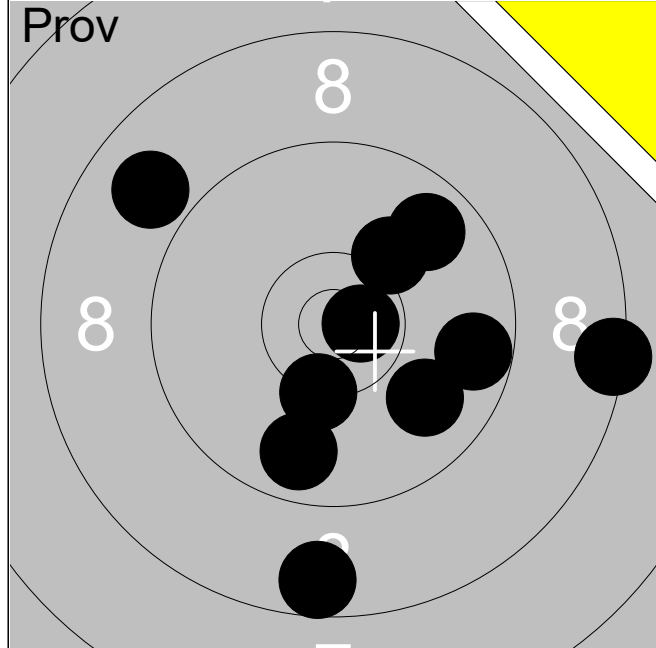

| | | |
|-----|-------|---|
| 1: | 10.7x | → |
| 2: | 9.8 | ↓ |
| 3: | 9.9 | ↘ |
| 4: | 10.1 | ↗ |
| 5: | 9.7 | → |
| 6: | 8.6 | ↓ |
| 7: | 8.4 | → |
| 8: | 9.8 | ↗ |
| 9: | 8.9 | ↖ |
| 10: | 10.3x | ↓ |

Serie 90

Total 0

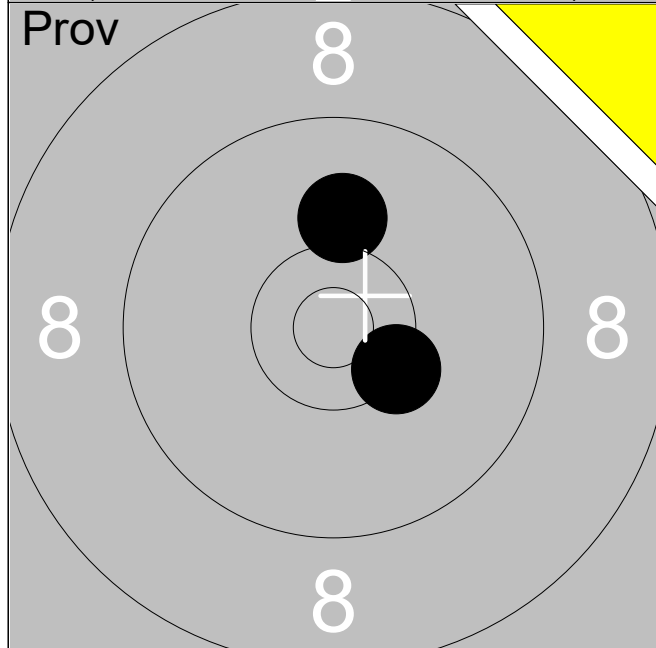

| | | |
|-----|-------|---|
| 11: | 10.4x | ↘ |
| 12: | 10.1 | ↑ |

Serie 20

Total 0

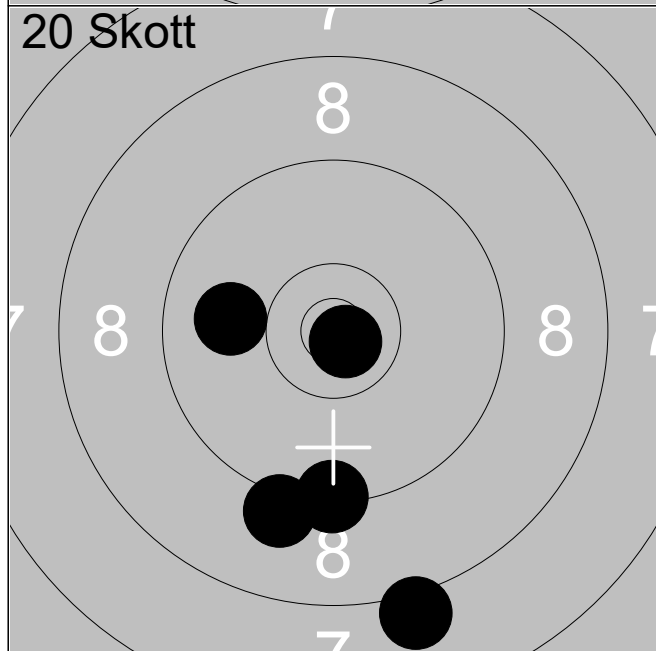

| | | |
|----|-------|---|
| 1: | 8.1 | ↓ |
| 2: | 9.9 | ← |
| 3: | 9.3 | ↓ |
| 4: | 9.1 | ↓ |
| 5: | 10.8x | ↘ |

Serie 45

Total 45

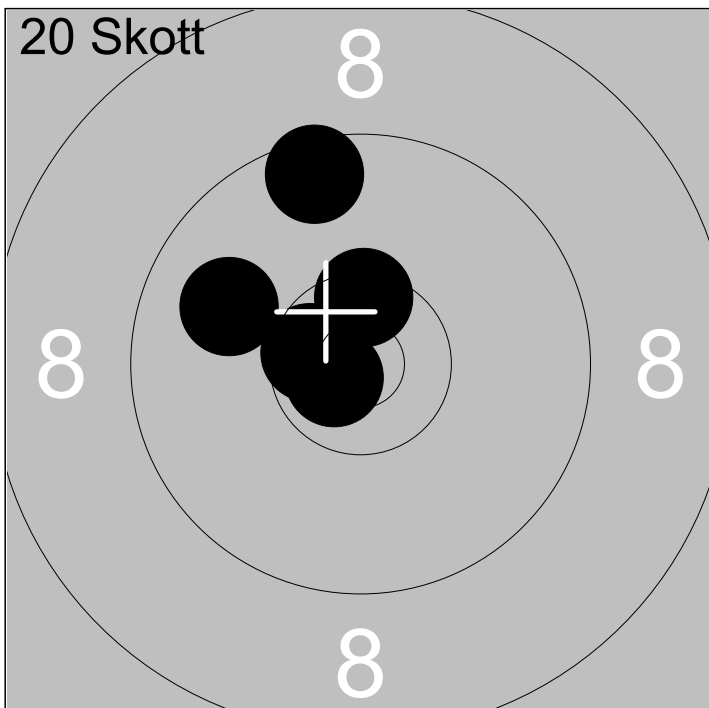

| | | |
|-----|-------|---|
| 6: | 10.6x | ← |
| 7: | 10.7x | ← |
| 8: | 10.5x | ↑ |
| 9: | 9.5 | ↑ |
| 10: | 9.9 | ← |

| | |
|-------|----|
| Serie | 48 |
| Total | 93 |

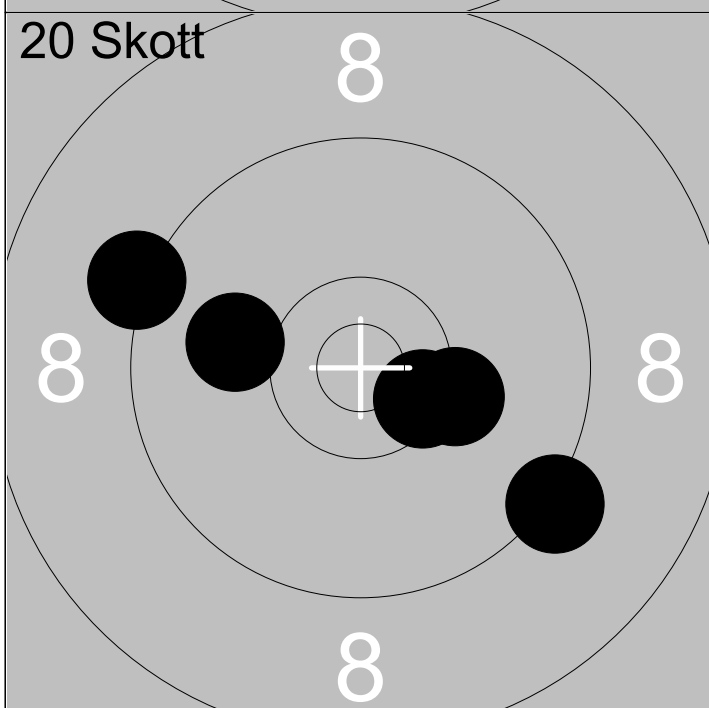

| | | |
|-----|-------|---|
| 11: | 9.2 | ↘ |
| 12: | 10.2 | ↘ |
| 13: | 10.0 | ← |
| 14: | 9.2 | ↖ |
| 15: | 10.5x | ↘ |

| | |
|-------|-----|
| Serie | 48 |
| Total | 141 |

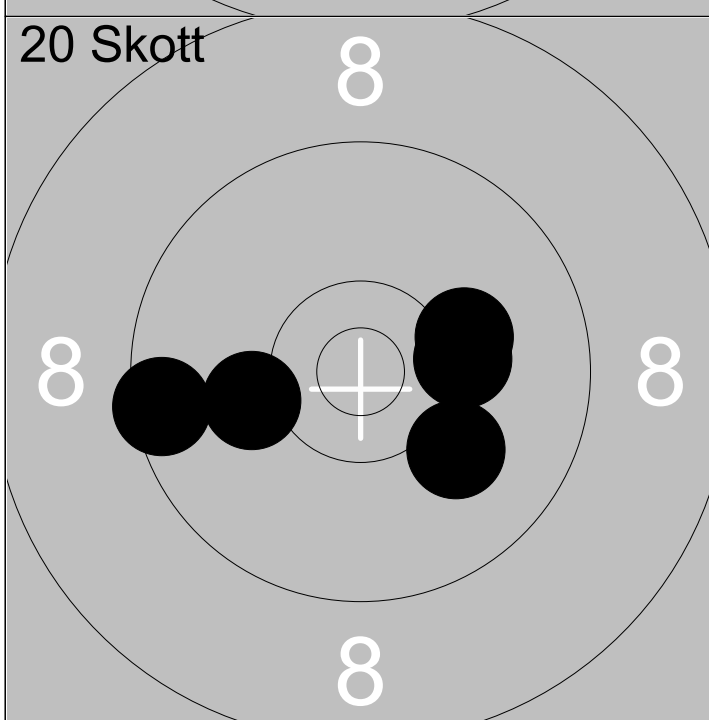

| | | |
|-----|------|---|
| 16: | 10.1 | ↘ |
| 17: | 10.1 | ← |
| 18: | 9.5 | ← |
| 19: | 10.2 | → |
| 20: | 10.2 | → |

| | |
|-------|-----|
| Serie | 49 |
| Total | 190 |