

1:	9.3	↗
2:	9.4	↗
3:	9.9	↗
4:	10.5x	↙
5:	10.0	↙
6:	10.4x	↙
7:	10.3	↗
8:	10.1	→
9:	10.6x	↗
10:	10.7x	↗

Serie **97**

Total **0**

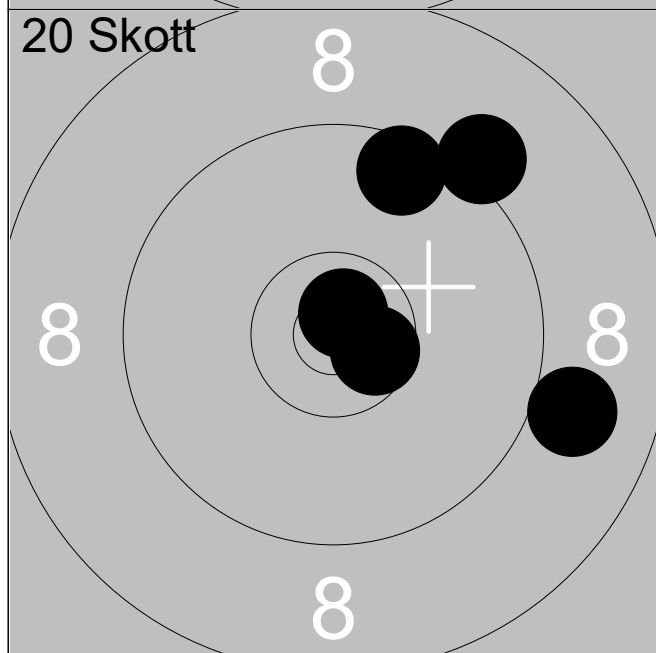

1:	10.6x	→
2:	9.6	↗
3:	9.0	→
4:	10.8x	↗
5:	9.1	↗

Serie **47**

Total **47**

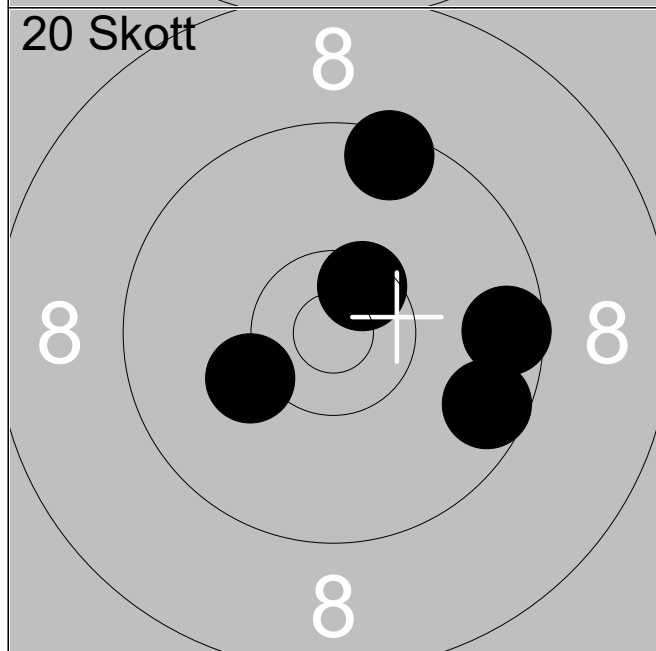

6:	9.5	↗
7:	9.6	→
8:	10.5x	↗
9:	10.2	↙
10:	9.6	→

Serie **47**

Total **94**

20 Skott

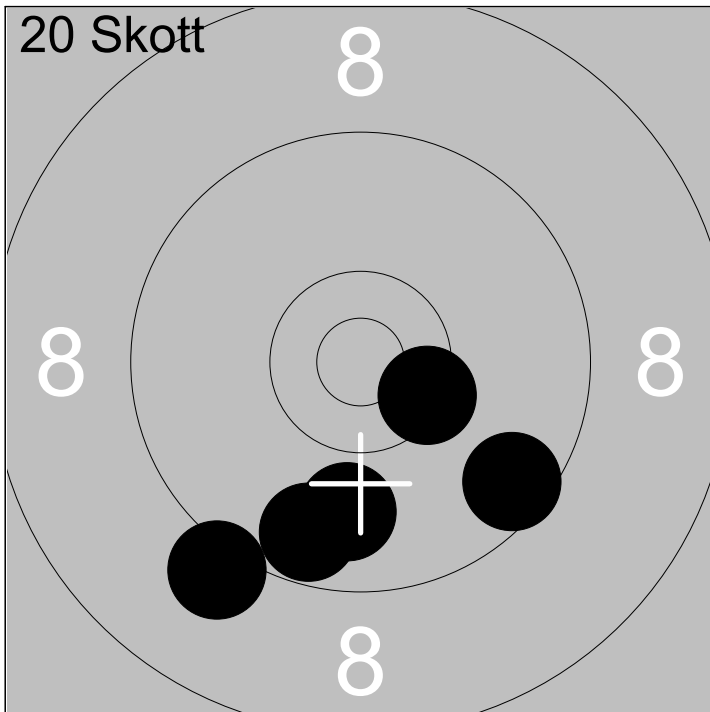

11:	10.4x	↘
12:	9.7	↓
13:	9.1	↙
14:	9.9	↓
15:	9.6	↘

Serie 46

Total 140

20 Skott

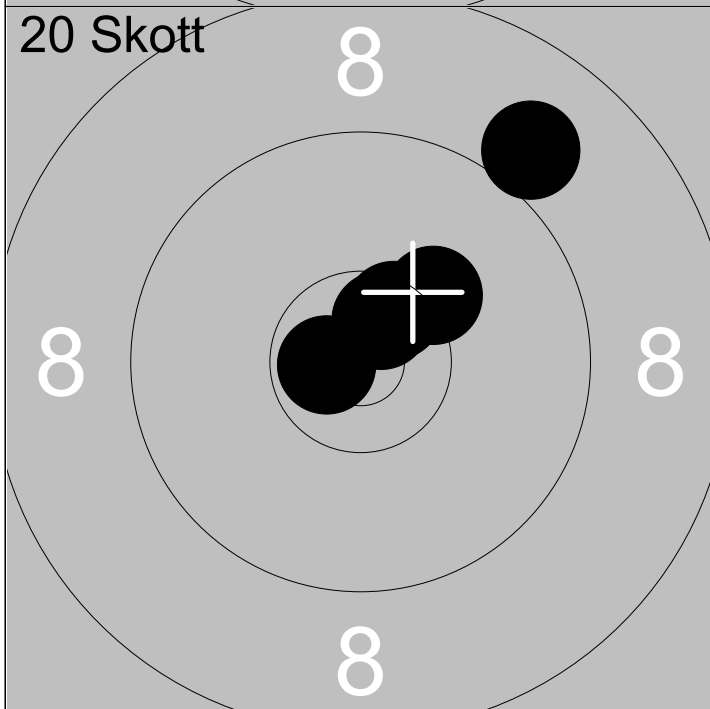

16:	10.7x	←
17:	10.5x	↗
18:	9.0	↗
19:	10.6x	↗
20:	10.2	↗

Serie 49

Total 189

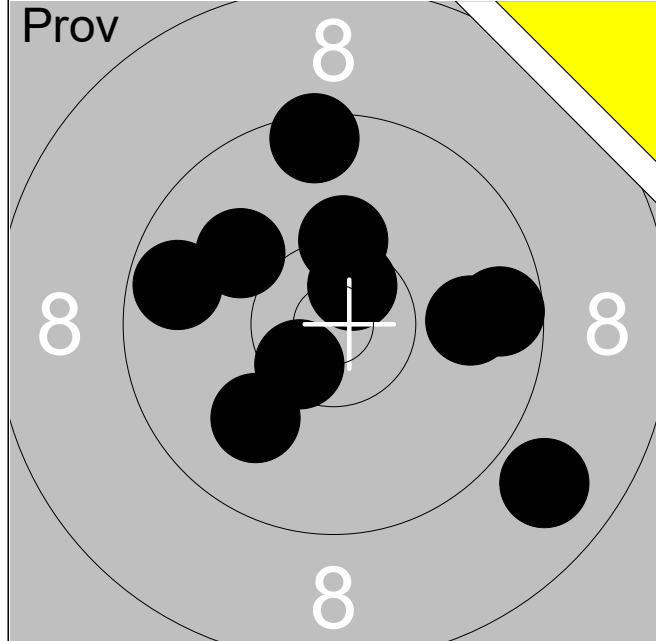

1:	9.5	↑
2:	10.0	↗
3:	9.7	←
4:	10.0	↘
5:	10.3	↑
6:	10.5x	↘
7:	9.6	→
8:	9.9	→
9:	10.6x	↗
10:	8.9	↘

Serie	94
-------	-----------

Total	0
-------	----------

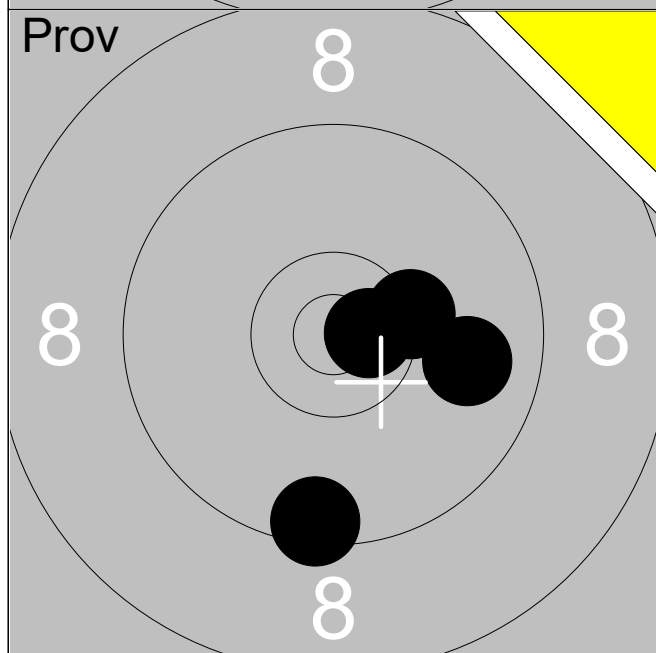

11:	10.3x	→
12:	10.7x	→
13:	9.9	→
14:	9.5	↓

Serie	38
-------	-----------

Total	0
-------	----------

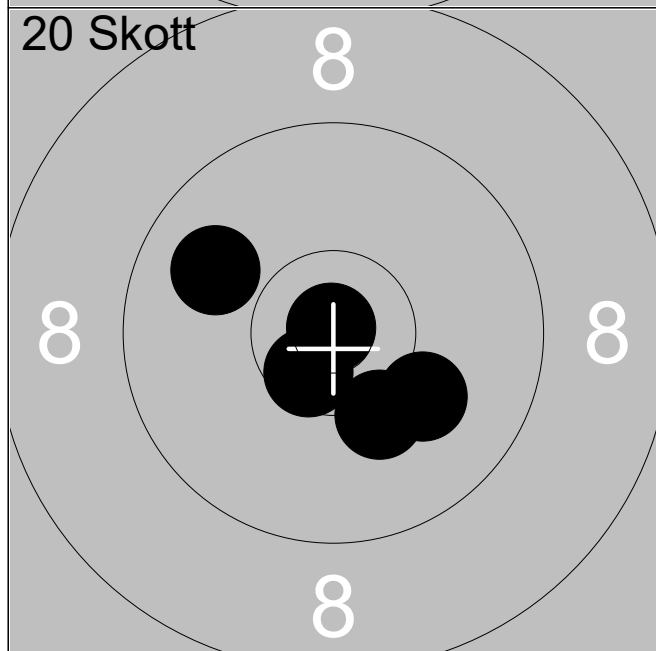

1:	10.9x	↗
2:	10.2	↘
3:	10.6x	↘
4:	10.1	↘
5:	9.9	↗

Serie	49
-------	-----------

Total	49
-------	-----------

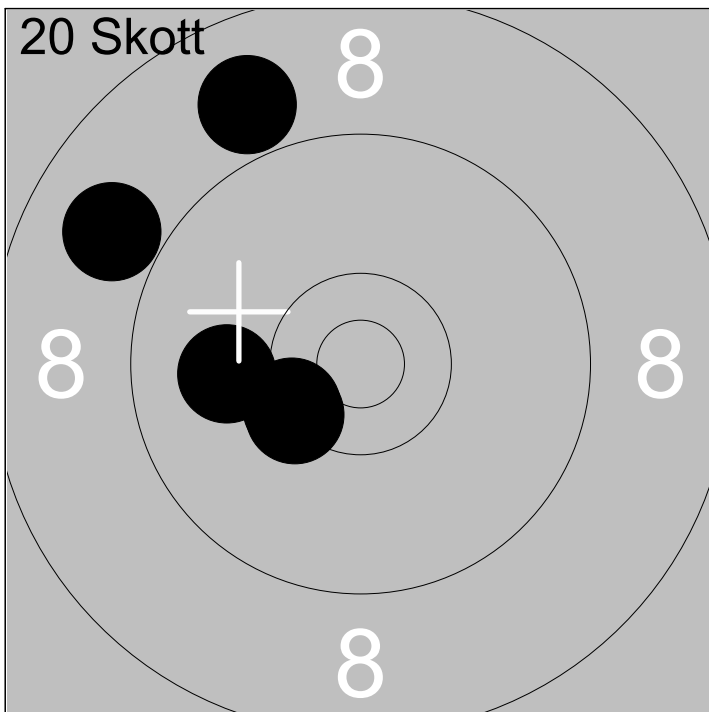

6:	10.4x	↙
7:	8.9	↖
8:	10.4x	↙
9:	10.0	←
10:	8.9	↗

Serie	46
Total	95

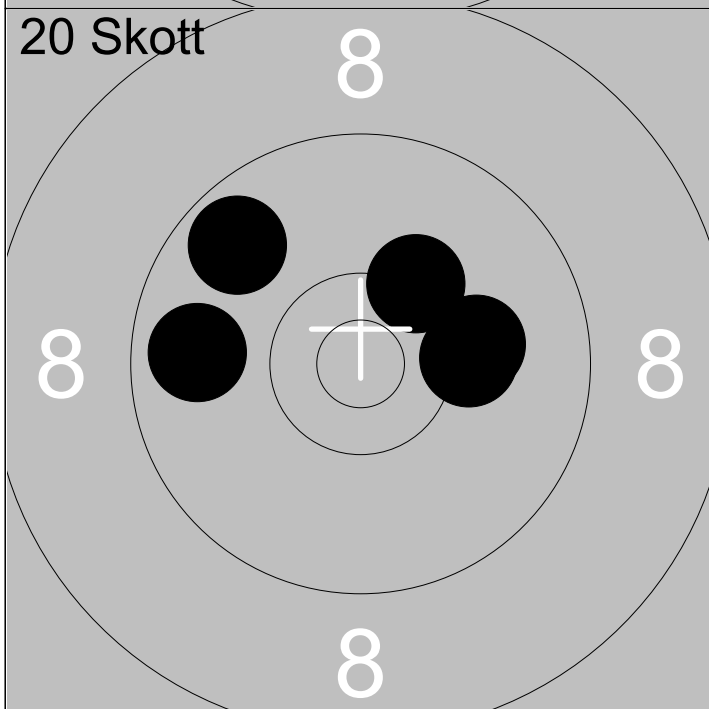

11:	10.1	→
12:	10.2	→
13:	10.3	↗
14:	9.7	↖
15:	9.8	←

Serie	48
Total	143

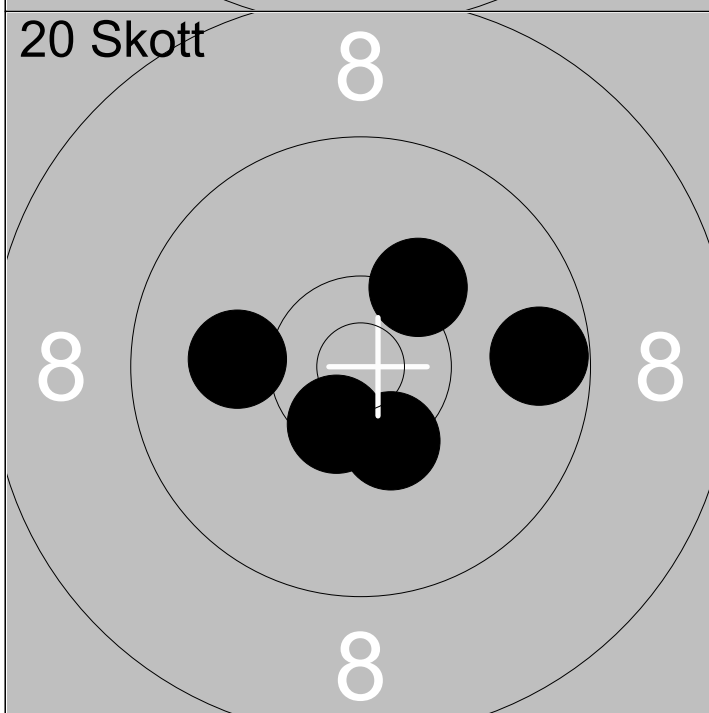

16:	10.5x	↘
17:	10.2	↗
18:	10.1	←
19:	10.4x	↘
20:	9.7	→

Serie	49
Total	192

Skjutlag 2	Tavla 3	Patrik Andreasson	
SM 2018 50m		Ystads Skyttegille	KL Öppen
27.07.2018		SM 2018 Ligg Nationellt	Kristinehamn skf

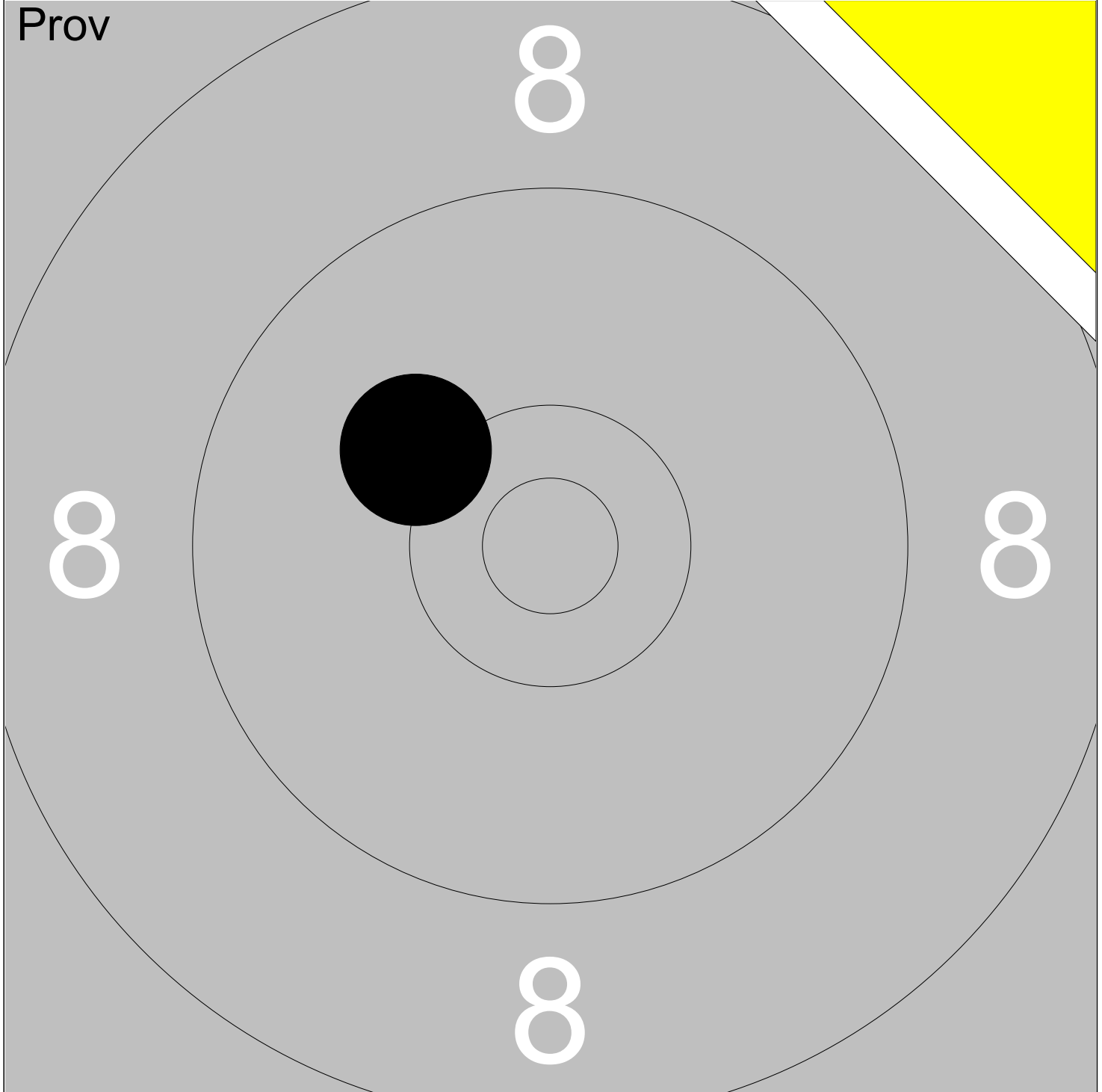

1: 10.2		Serie	10
		Total	0

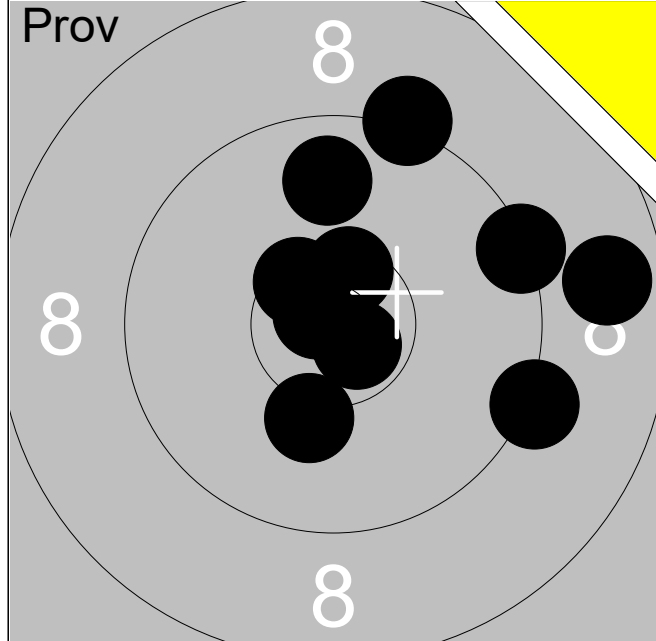

1:	9.2	↗
2:	10.7x	↘
3:	10.2	↘
4:	9.2	↗
5:	10.8x	↗
6:	8.8	→
7:	10.5x	↗
8:	10.5x	↑
9:	9.4	↗
10:	9.8	↑

Serie	94
-------	-----------

Total	0
-------	----------

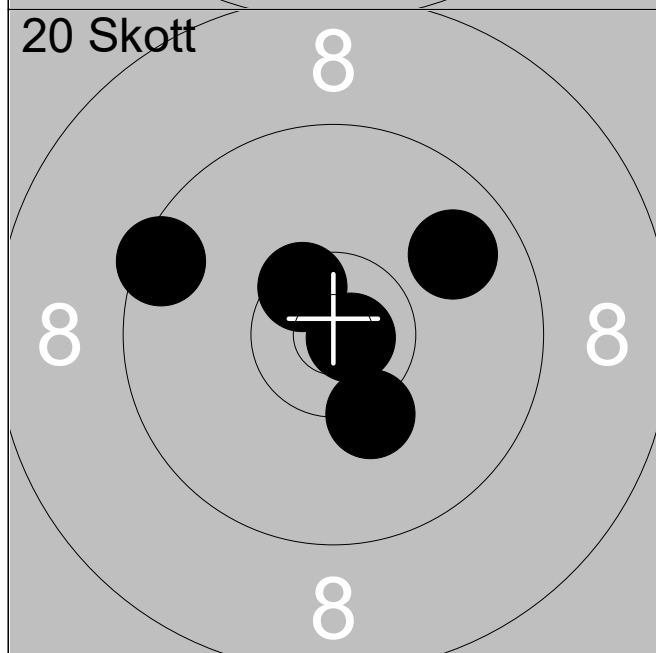

1:	10.3	↘
2:	10.5x	↗
3:	9.8	↗
4:	10.8x	→
5:	9.5	↖

Serie	48
-------	-----------

Total	48
-------	-----------

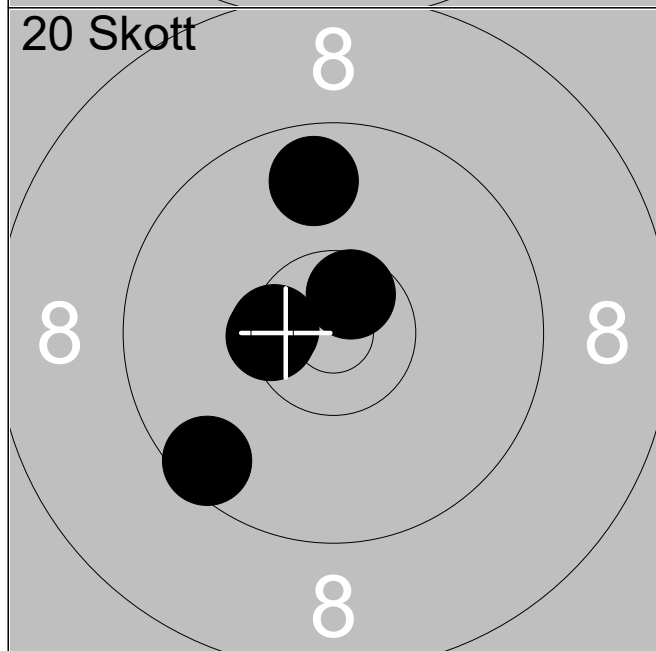

6:	9.7	↑
7:	9.5	↘
8:	10.5x	←
9:	10.6x	↗
10:	10.5x	←

Serie	48
-------	-----------

Total	96
-------	-----------

20 Skott

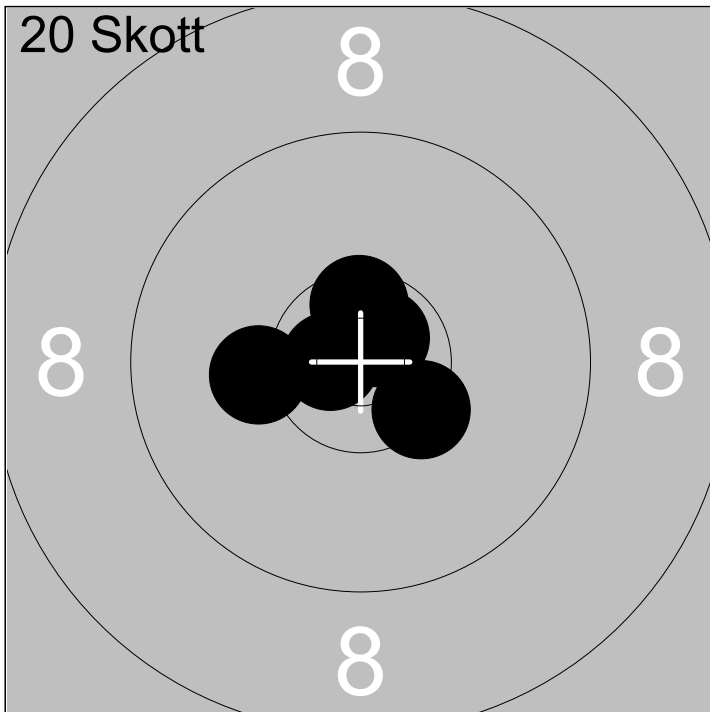

11:	10.4x	↘
12:	10.5x	↑
13:	10.7x	←
14:	10.7x	↗
15:	10.2	←

Serie 50

Total 146

20 Skott

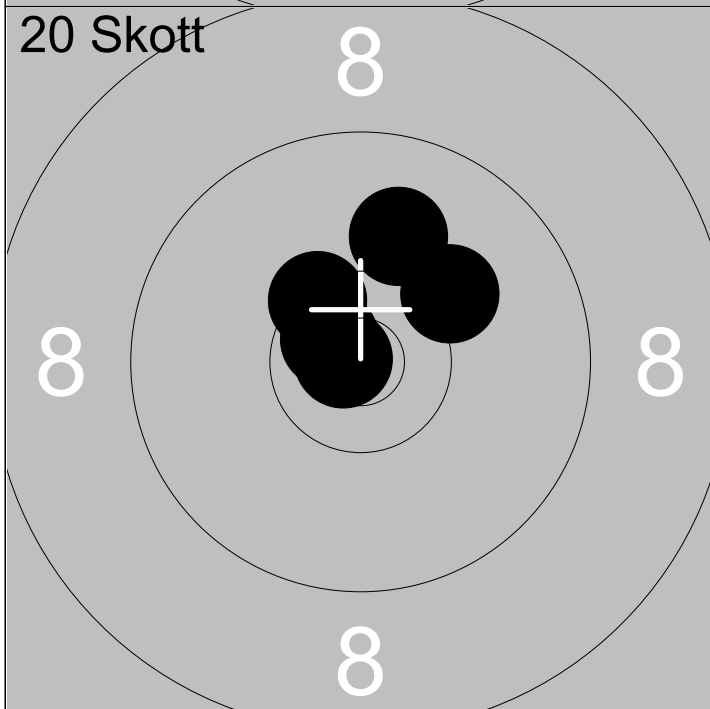

16:	10.7x	↖
17:	10.0	↑
18:	10.1	↗
19:	10.4x	↗
20:	10.8x	←

Serie 50

Total 196

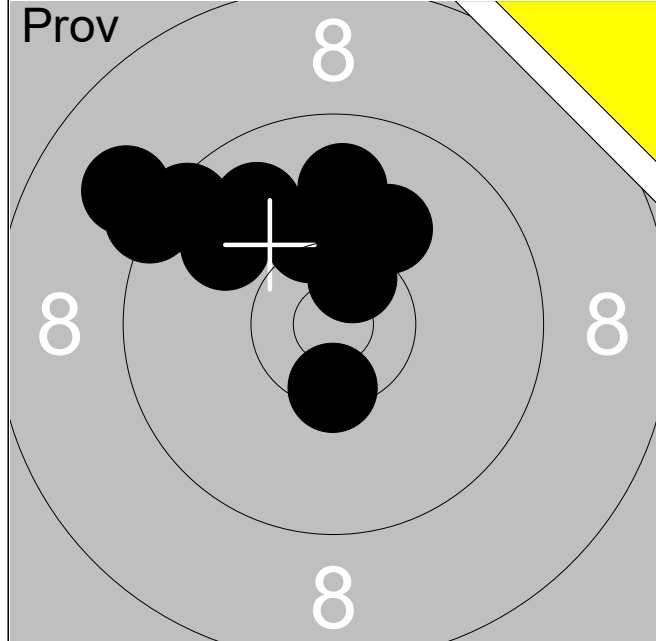

1:	9.9	↖
2:	9.9	↑
3:	9.0	↖
4:	9.5	↖
5:	9.8	↖
6:	10.1	↖
7:	10.2	↑
8:	9.3	↖
9:	10.6x	↖
10:	10.5x	↓
Serie		94
Total		0

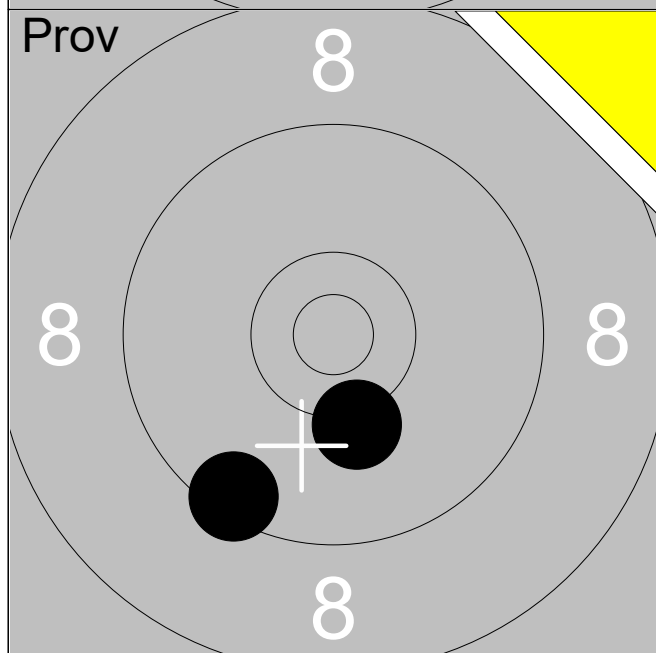

11:	10.2	↓
12:	9.5	↘
Serie		19
Total		0

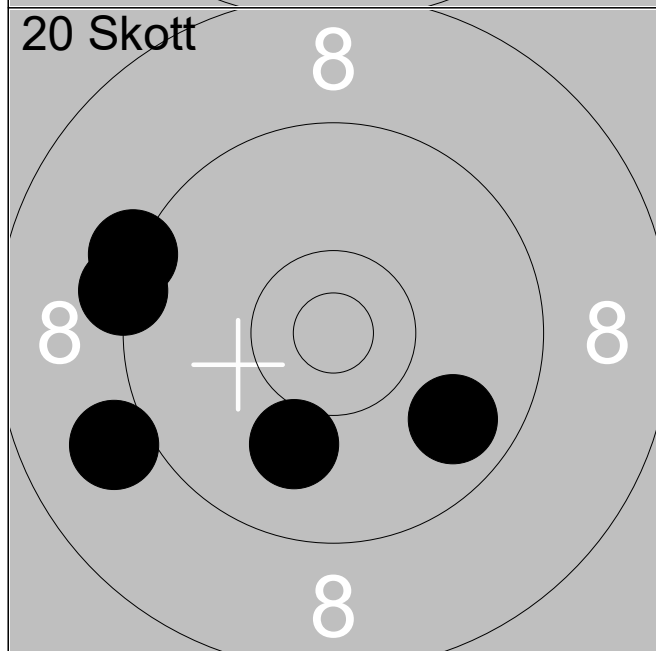

1:	9.3	←
2:	9.8	↘
3:	10.0	↓
4:	9.3	↖
5:	9.0	↖
Serie		46
Total		46

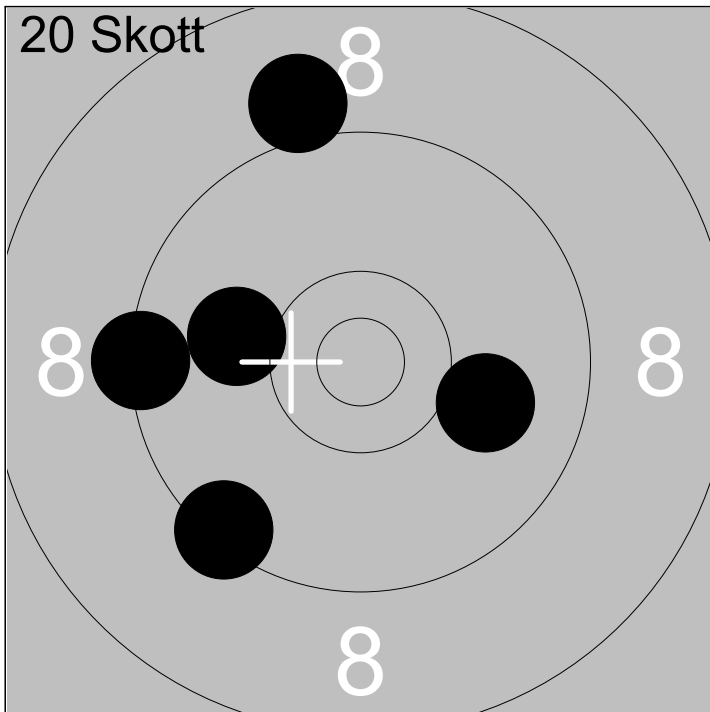

6:	9.4	←
7:	10.0	←
8:	9.4	↙
9:	9.0	↑
10:	10.0	↘

Serie	47
Total	93

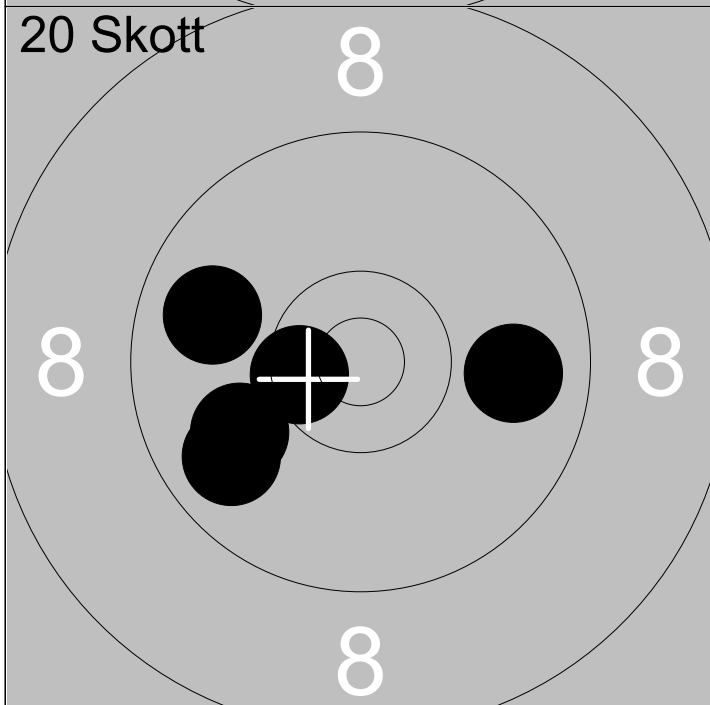

11:	9.9	↙
12:	9.8	↙
13:	10.5x	←
14:	9.9	→
15:	9.8	↙

Serie	46
Total	139

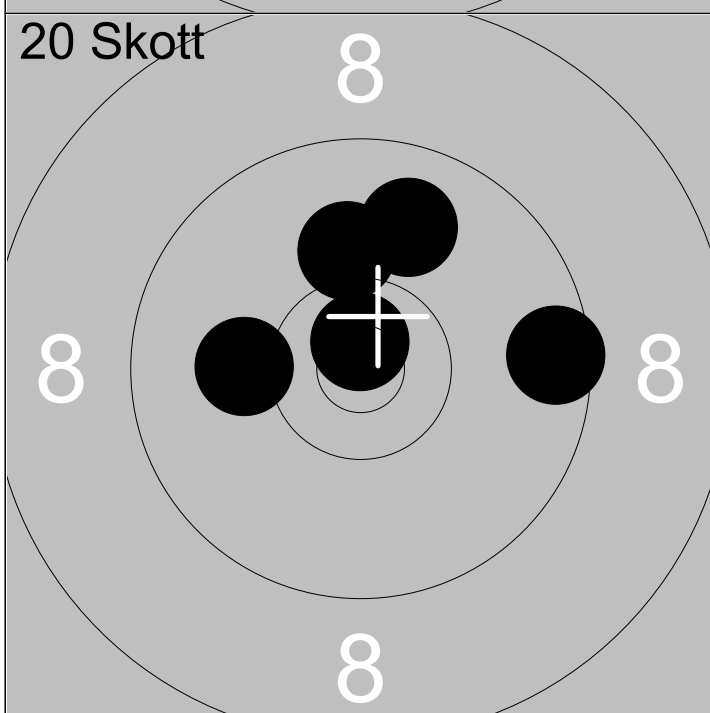

16:	10.1	↑
17:	9.9	↑
18:	9.5	→
19:	10.8x	↑
20:	10.1	←

Serie	48
Total	187

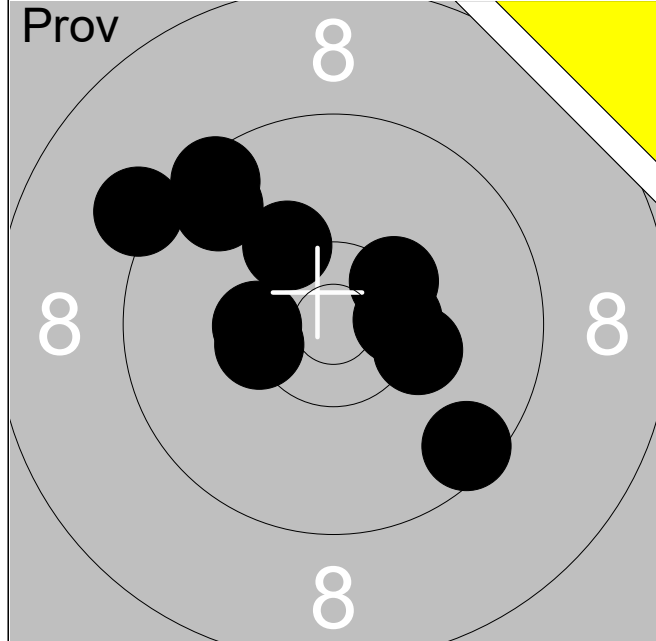

1:	9.5	↗
2:	10.3x	←
3:	9.5	↘
4:	10.3	→
5:	10.4x	↗
6:	10.2	↗
7:	9.7	↗
8:	10.4x	→
9:	9.2	↗
10:	10.3x	←

Serie	96
-------	----

Total	0
-------	---

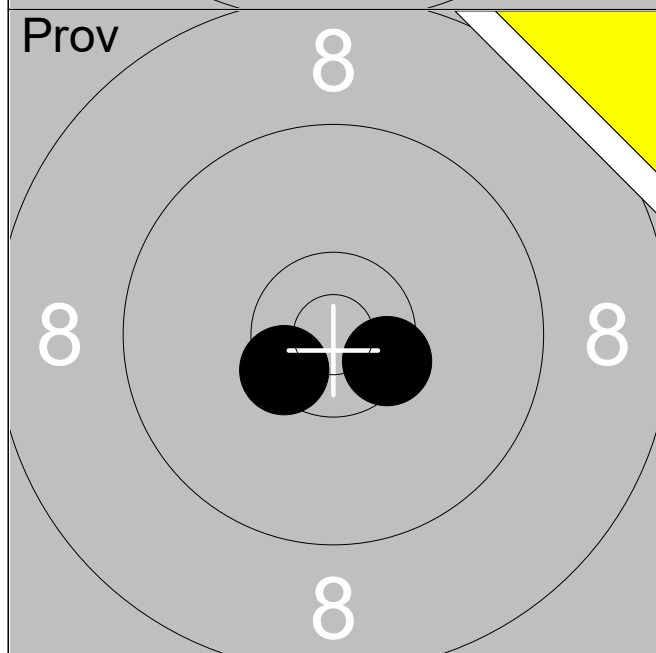

11:	10.5x	↘
12:	10.5x	↙

Serie	20
-------	----

Total	0
-------	---

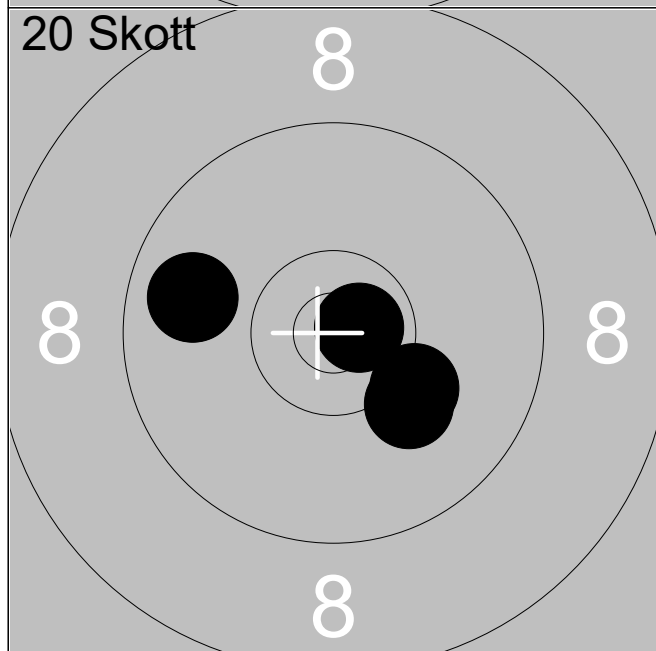

1:	10.7x	→
2:	10.2	↘
3:	9.8	←
4:	9.8	←
5:	10.1	↘

Serie	48
-------	----

Total	48
-------	----

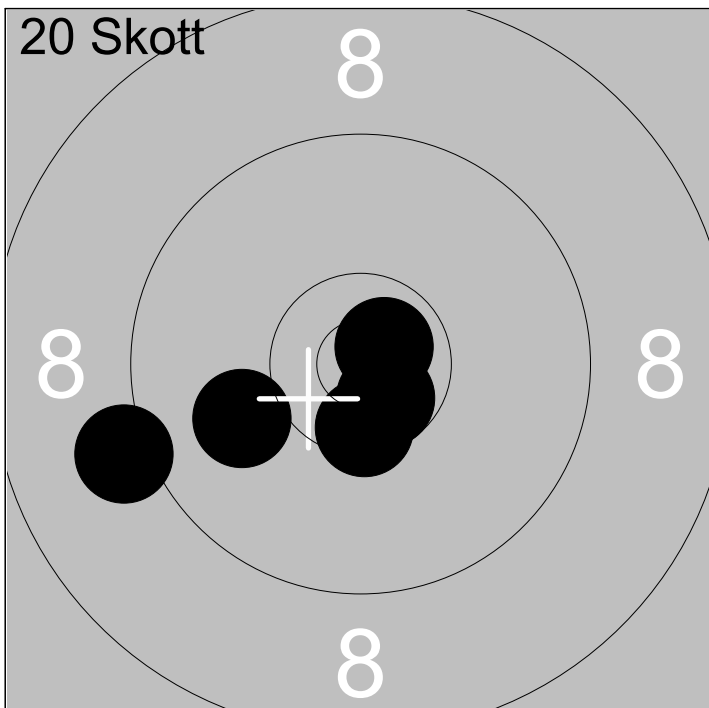

6:	9.1	←
7:	10.6x	↘
8:	10.0	←
9:	10.5x	↓
10:	10.7x	↗

Serie	49
Total	97

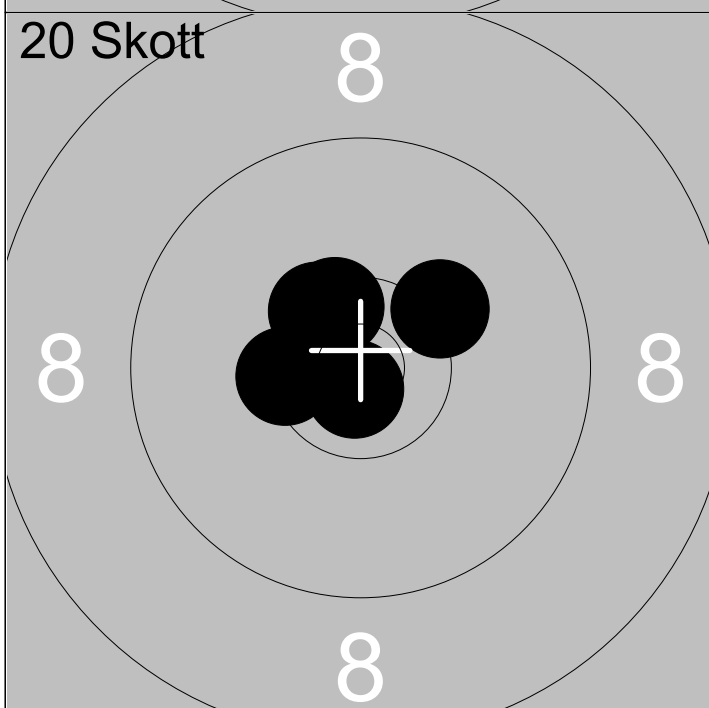

11:	10.8x	↓
12:	10.2	↗
13:	10.4x	←
14:	10.4x	↗
15:	10.5x	↗

Serie	50
Total	147

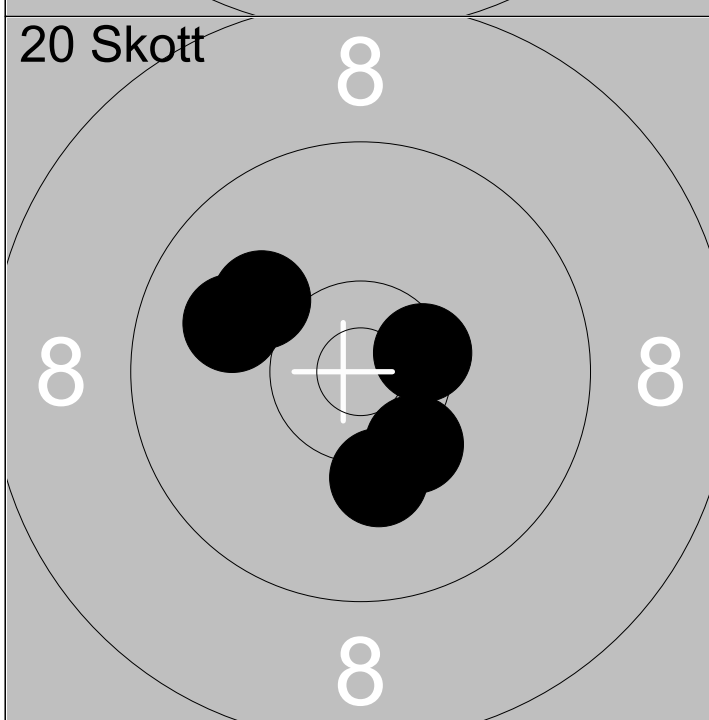

16:	10.1	↗
17:	10.2	↓
18:	10.0	←
19:	10.5x	→
20:	10.3x	↘

Serie	50
Total	197

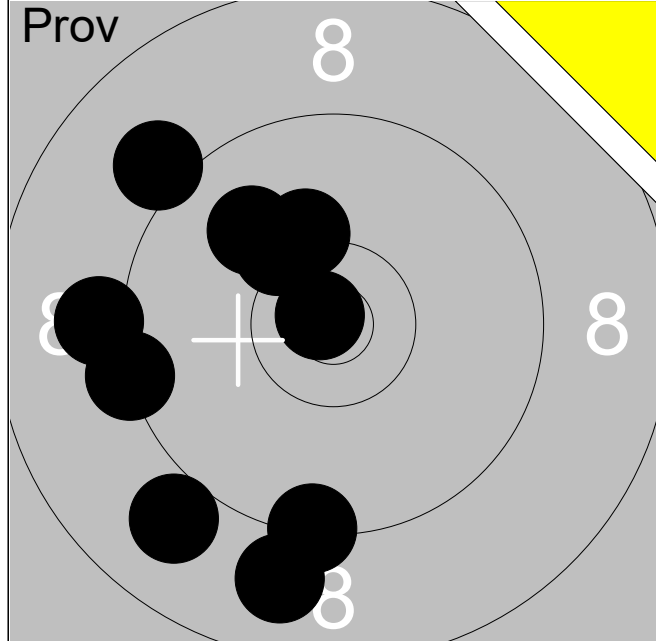

1:	9.0	↙
2:	9.1	↗
3:	10.8x	↗
4:	8.9	↘
5:	10.0	↗
6:	10.2	↗
7:	9.3	↖
8:	10.2	↗
9:	9.1	↖
10:	9.3	↘

Serie	93
-------	-----------

Total	0
-------	----------

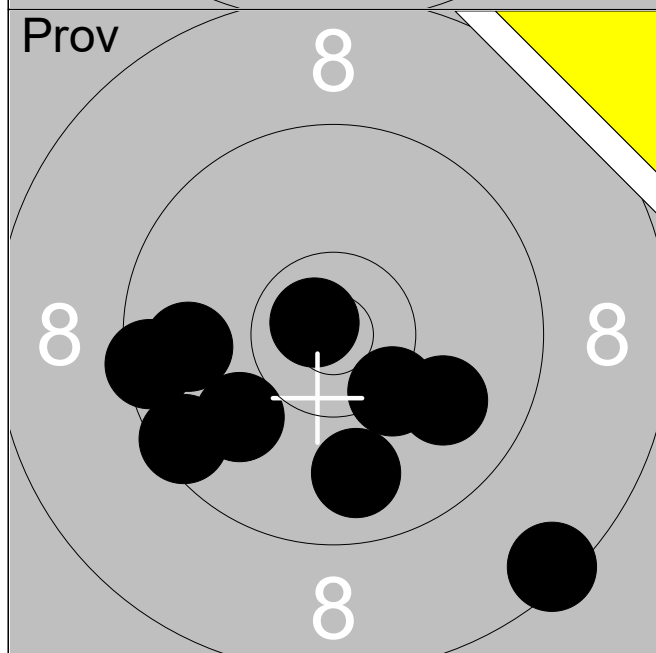

11:	8.4	↘
12:	10.3x	↘
13:	10.0	↘
14:	9.8	↘
15:	9.8	↖
16:	9.9	↘
17:	10.8x	↗
18:	9.5	↖
19:	9.5	↖

Serie	83
-------	-----------

Total	0
-------	----------

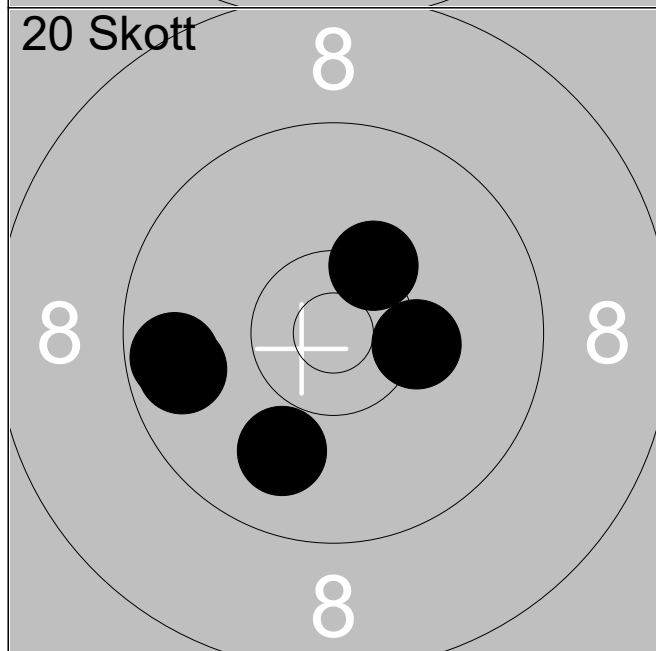

1:	9.9	↘
2:	9.7	↖
3:	10.3x	↗
4:	10.3x	→
5:	9.7	↖

Serie	47
-------	-----------

Total	47
-------	-----------

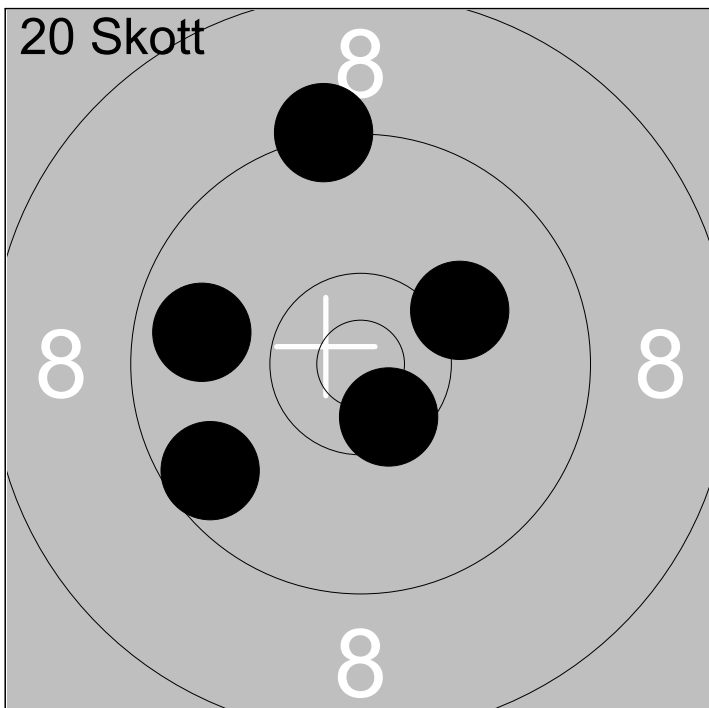

6:	9.3	↑
7:	10.5x	↓
8:	9.6	↙
9:	9.8	↖
10:	10.1	↗

Serie	47
Total	94

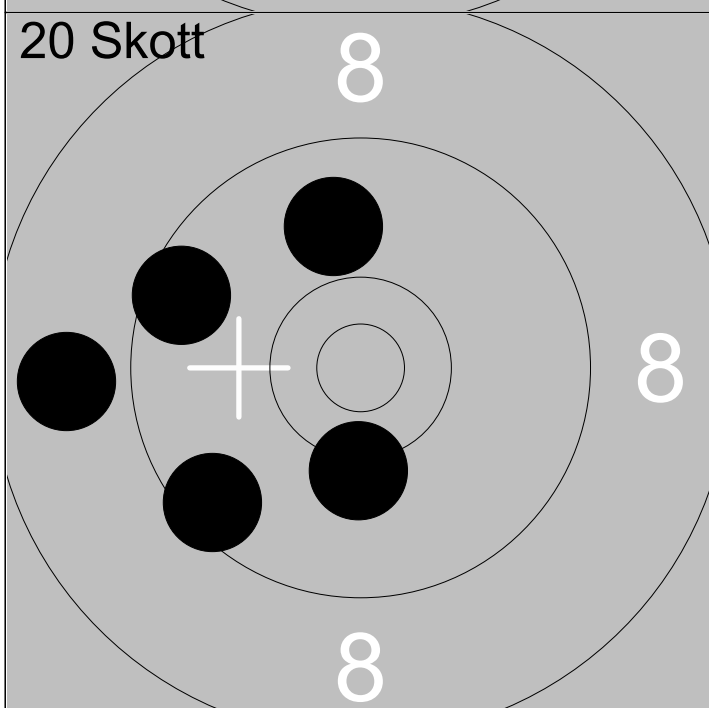

11:	9.6	↖
12:	8.8	↖
13:	10.2	↓
14:	9.9	↑
15:	9.5	↙

Serie	45
Total	139

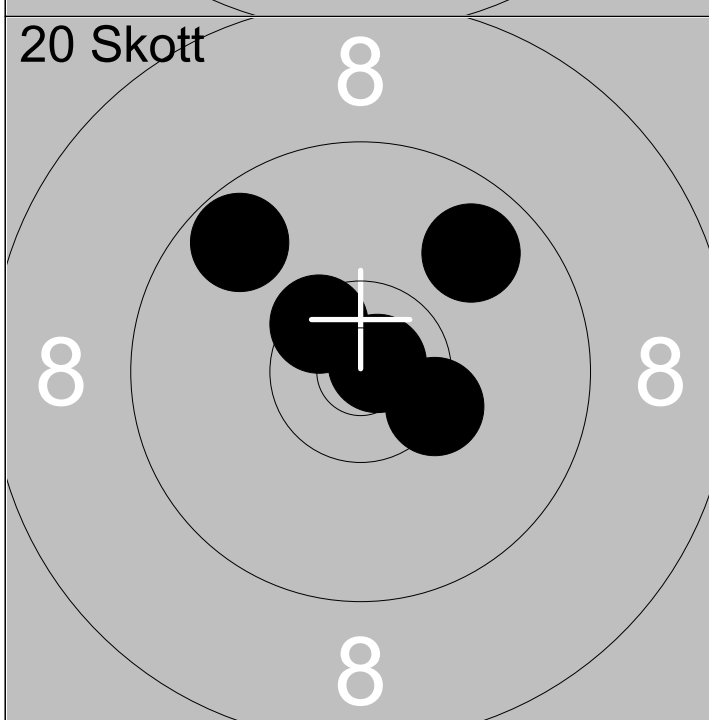

16:	9.7	↖
17:	10.4x	↗
18:	9.8	↗
19:	10.8x	↗
20:	10.5x	↖

Serie	48
Total	187

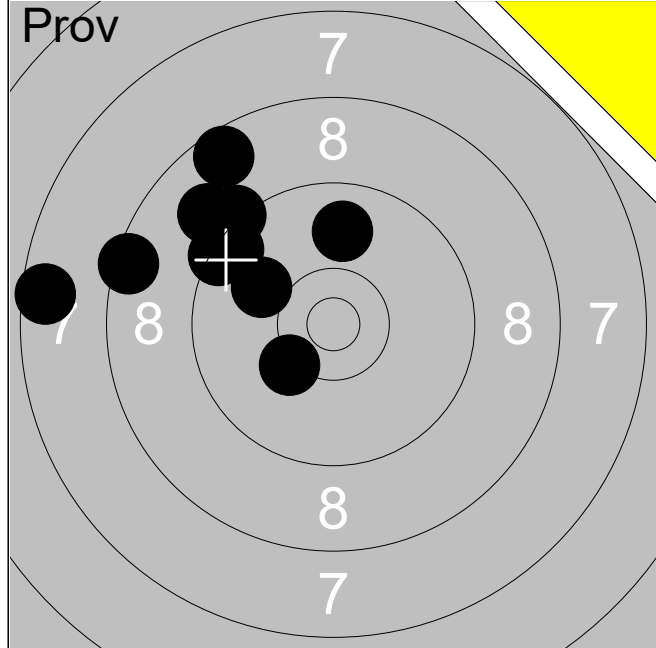

1:	8.6	↗
2:	7.6	←
3:	10.3	↘
4:	9.5	↗
5:	8.5	←
6:	9.2	↗
7:	9.4	↗
8:	10.0	↗
9:	9.0	↗
10:	9.9	↑

Serie	88
-------	----

Total	0
-------	---

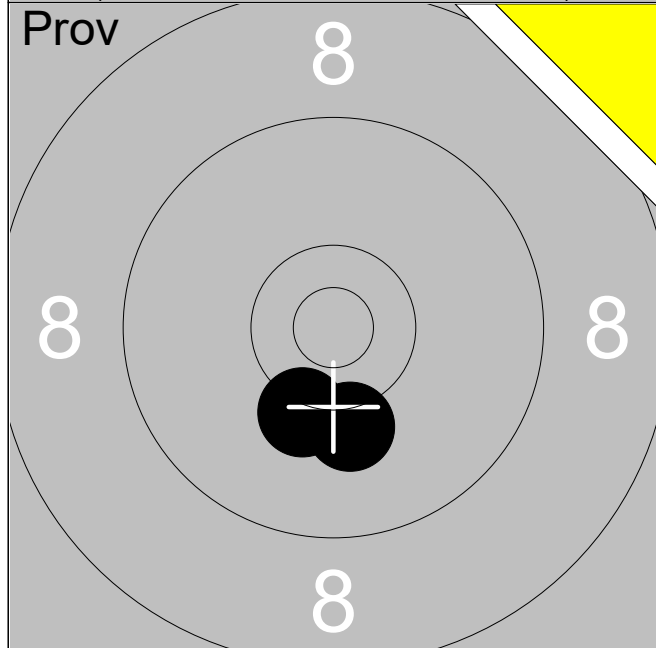

11:	10.2	↘
12:	10.2	↘

Serie	20
-------	----

Total	0
-------	---

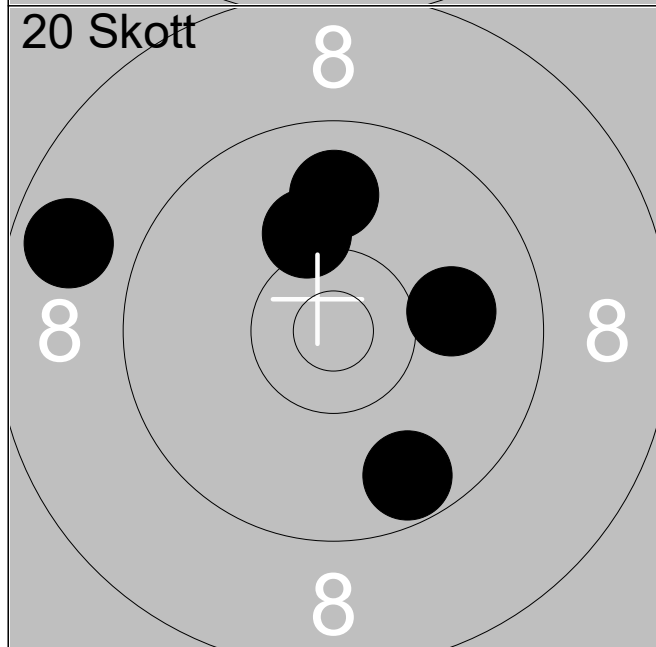

1:	8.8	←
2:	9.7	↘
3:	10.2	↑
4:	9.9	↑
5:	10.0	→

Serie	46
-------	----

Total	46
-------	----

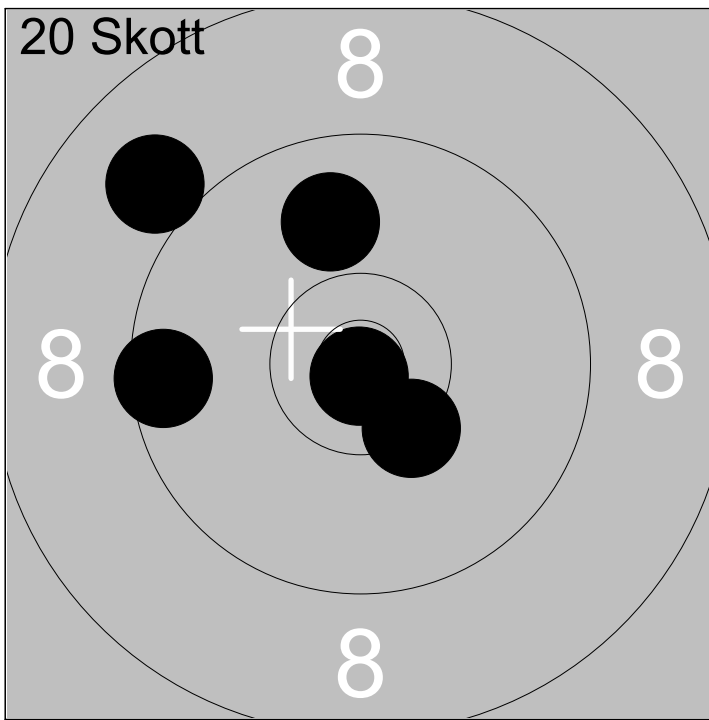

6:	9.9	↑
7:	9.0	↖
8:	10.9x	↓
9:	9.5	←
10:	10.4x	↘

Serie	47
Total	93

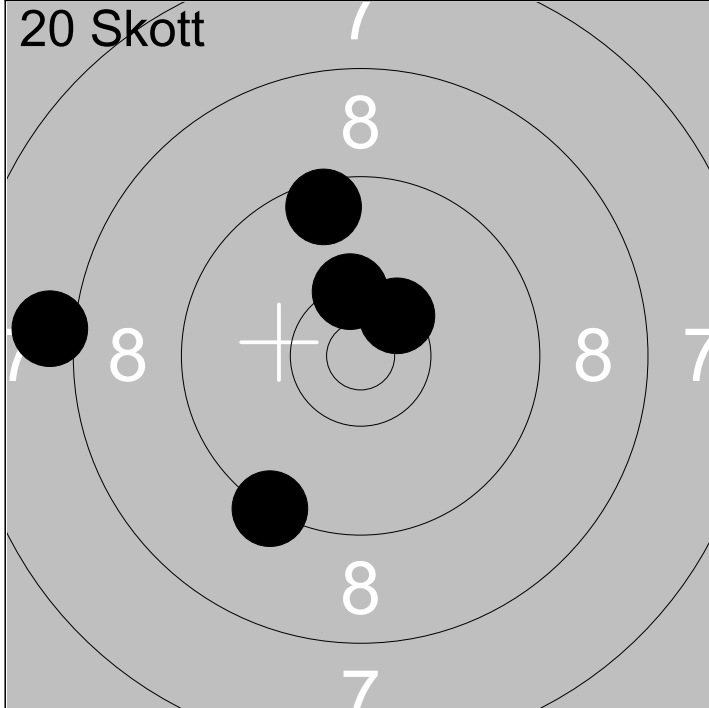

11:	10.4x	↗
12:	9.5	↑
13:	8.1	←
14:	10.3x	↑
15:	9.3	↘

Serie	46
Total	139

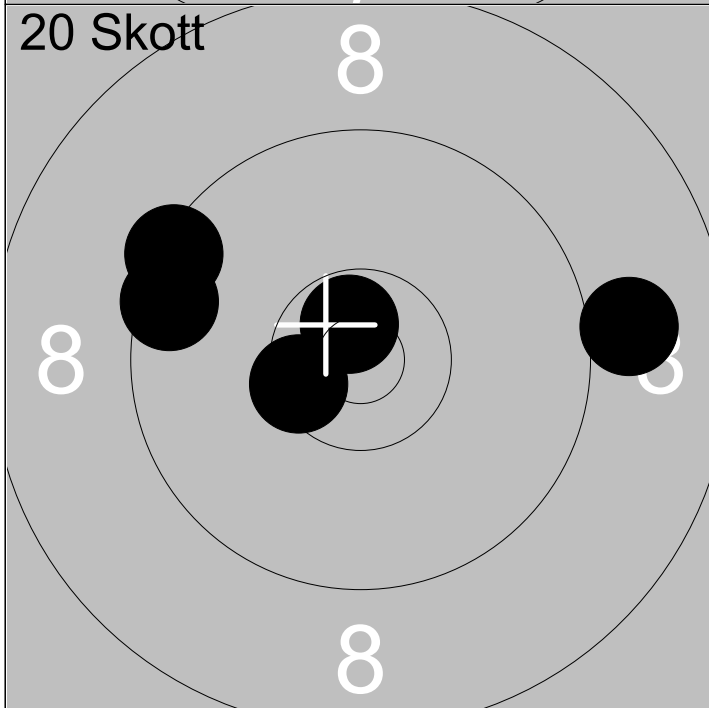

16:	9.0	→
17:	10.7x	↑
18:	9.4	↖
19:	10.5x	←
20:	9.5	←

Serie	47
Total	186

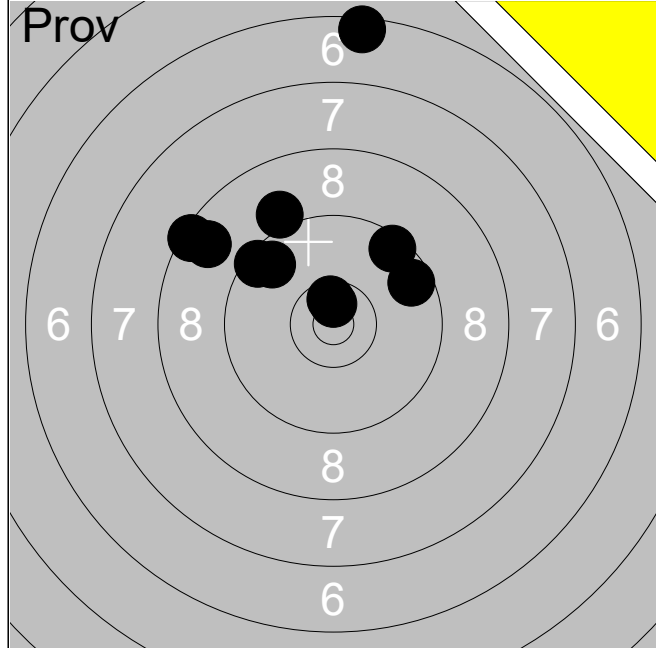

1:	6.5	↑
2:	8.4	↖
3:	9.6	↗
4:	10.6x	↑
5:	9.7	↗
6:	9.5	↗
7:	9.1	↗
8:	10.6x	↑
9:	8.7	↖
10:	9.5	↗
Serie	87	
Total	0	

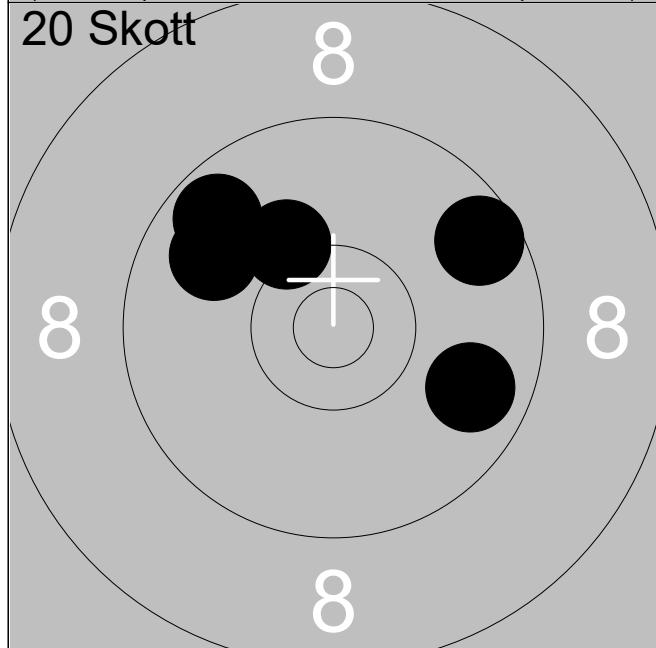

1:	9.6	↗
2:	10.2	↗
3:	9.8	↘
4:	9.7	↗
5:	9.9	↗
Serie	46	
Total	46	

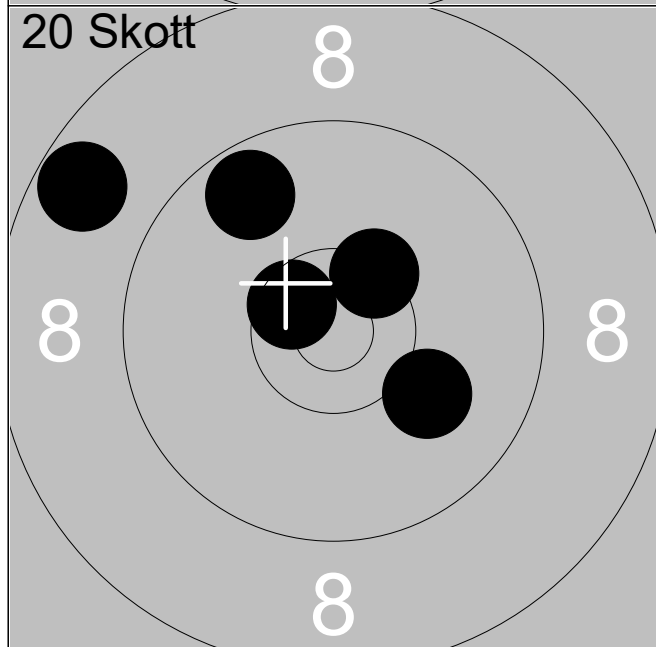

6:	8.7	↖
7:	10.6x	↗
8:	10.4x	↗
9:	9.7	↗
10:	10.1	↘
Serie	47	
Total	93	

20 Skott

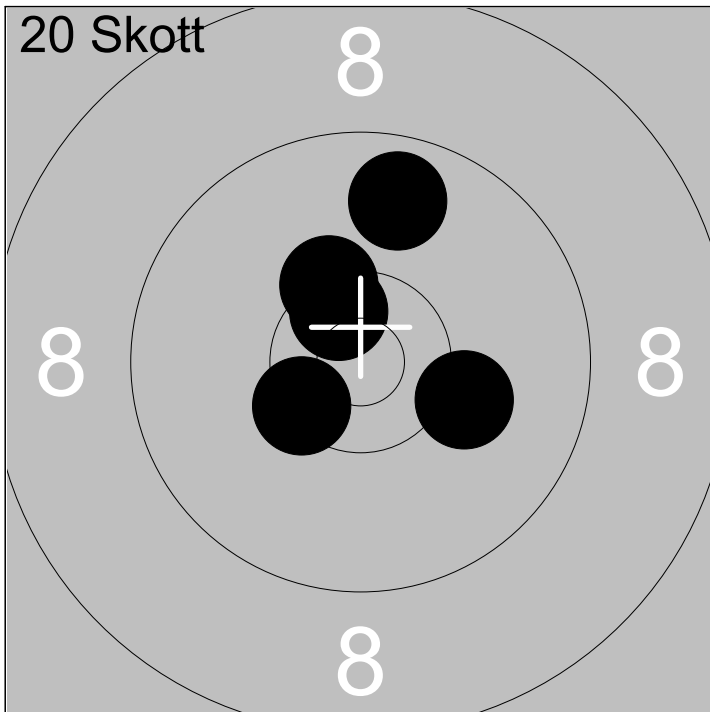

11:	10.4x	↗
12:	9.8	↑
13:	10.6x	↖
14:	10.4x	↙
15:	10.2	↘

Serie 49

Total 142

20 Skott

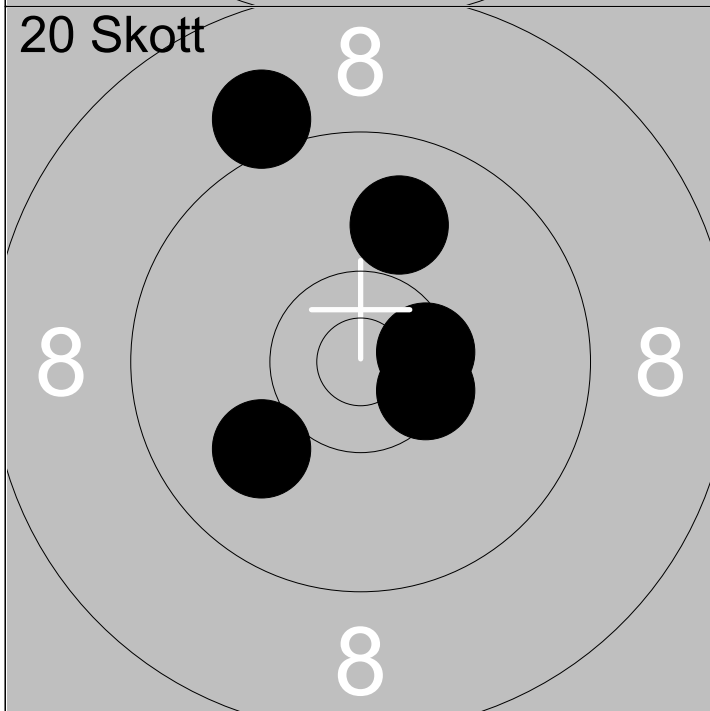

16:	10.0	↙
17:	9.1	↖
18:	9.9	↑
19:	10.4x	↘
20:	10.5x	→

Serie 48

Total 190

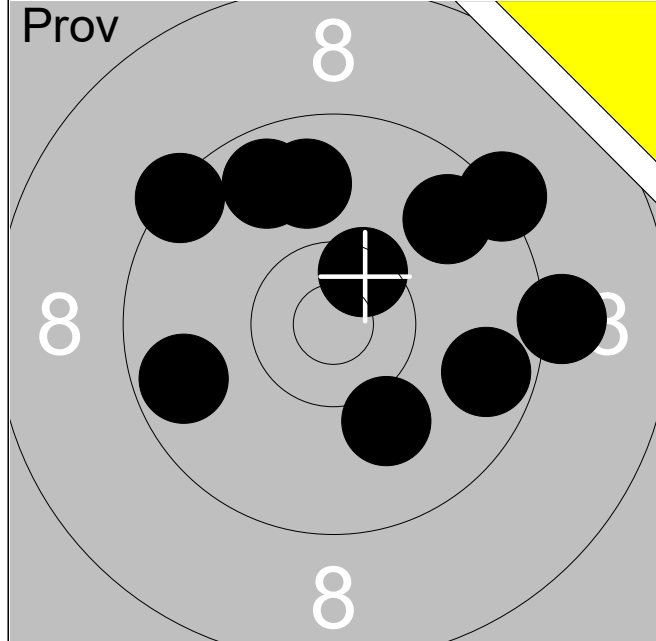

1:	10.1	↘
2:	9.7	→
3:	9.3	↗
4:	9.4	↖
5:	9.2	→
6:	10.5x	↗
7:	9.8	↑
8:	9.7	↗
9:	9.7	↖
10:	9.7	←

Serie	92
-------	-----------

Total	0
-------	----------

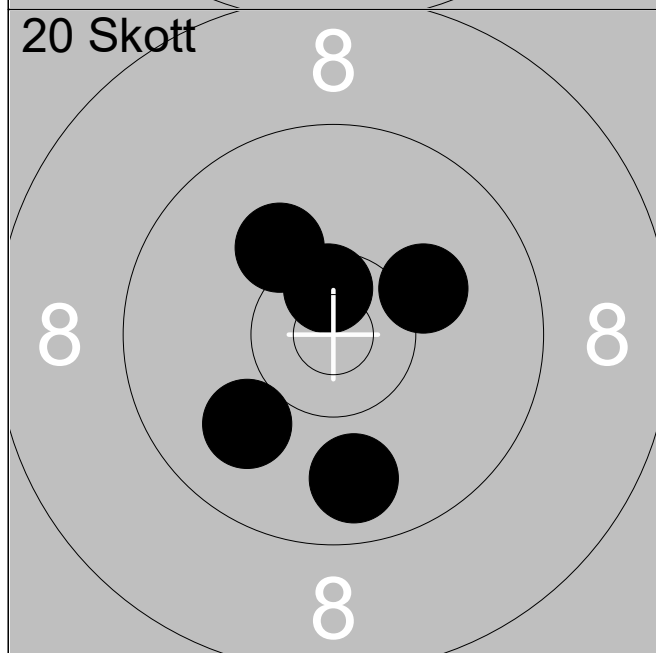

1:	10.0	↙
2:	10.6x	↑
3:	9.8	↓
4:	10.2	→
5:	10.1	↖

Serie	49
-------	-----------

Total	49
-------	-----------

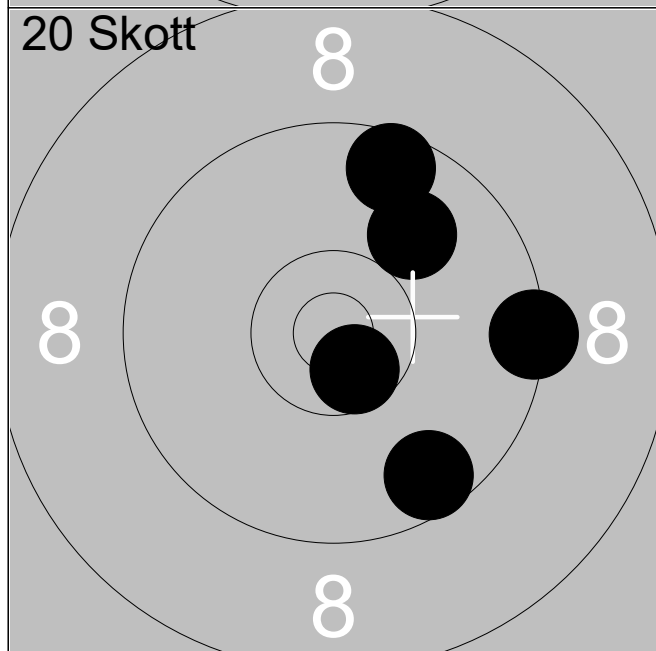

6:	10.6x	↘
7:	9.6	↑
8:	10.0	↗
9:	9.6	↓
10:	9.4	→

Serie	47
-------	-----------

Total	96
-------	-----------

20 Skott

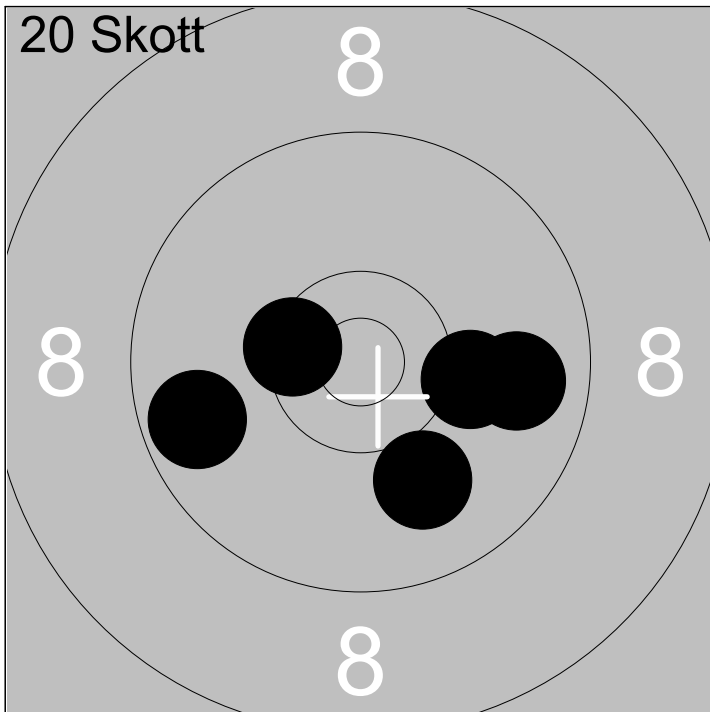

11:	10.2	→
12:	10.0	↘
13:	10.5x	←
14:	9.8	→
15:	9.7	←

Serie 48

Total 144

20 Skott

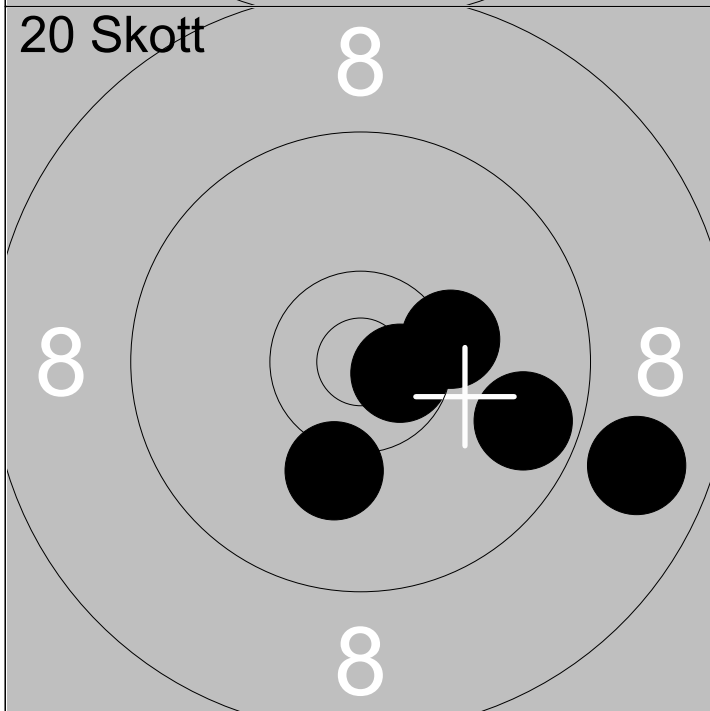

16:	10.1	↓
17:	9.7	→
18:	8.8	↘
19:	10.7x	→
20:	10.3	→

Serie 47

Total 191

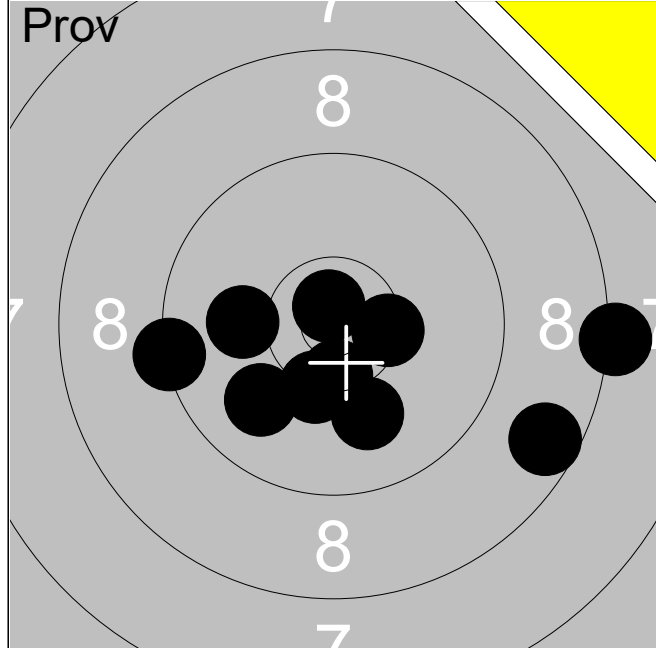

1:	10.1	←
2:	8.6	↘
3:	10.4x	→
4:	9.9	↙
5:	10.5x	↓
6:	8.2	→
7:	10.0	↘
8:	9.3	←
9:	10.3x	↘
10:	10.8x	↑

Serie	94
-------	-----------

Total	0
-------	----------

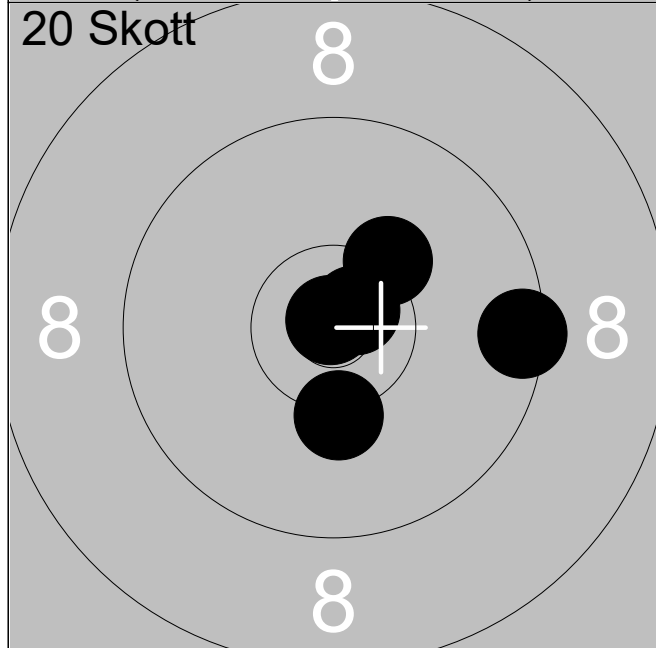

1:	10.3	↗
2:	9.5	→
3:	10.7x	↗
4:	10.3	↓
5:	10.9x	↗

Serie	49
-------	-----------

Total	49
-------	-----------

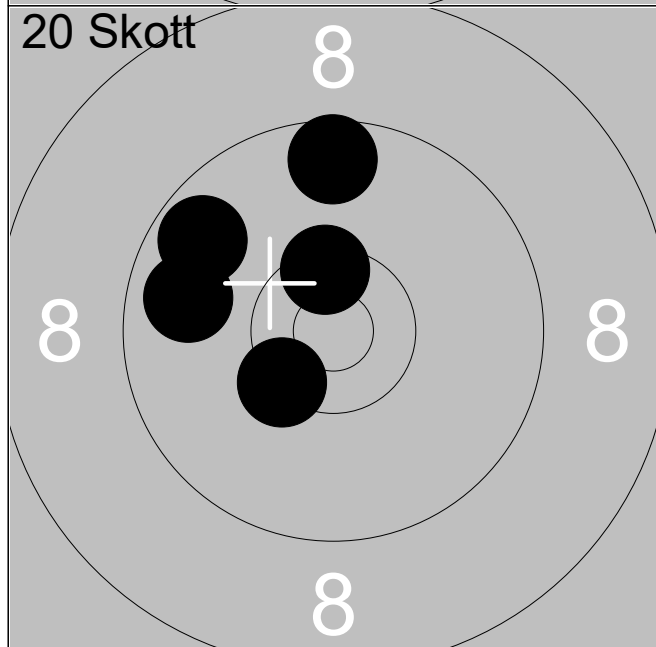

6:	10.4x	↙
7:	10.5x	↑
8:	9.8	←
9:	9.6	↑
10:	9.7	↖

Serie	47
-------	-----------

Total	96
-------	-----------

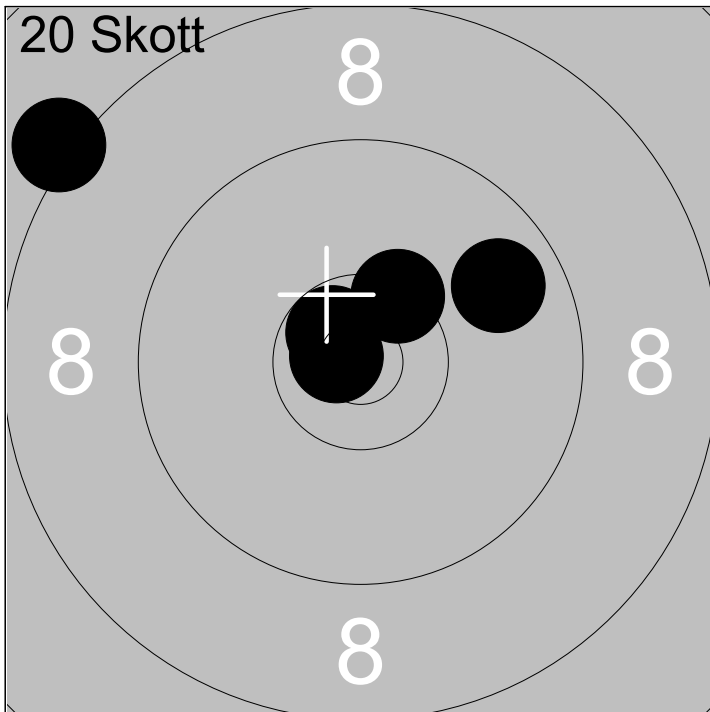

11:	8.2	↖
12:	10.8x	↙
13:	9.8	↗
14:	10.4x	↗
15:	10.6x	↖

Serie 47

Total 143

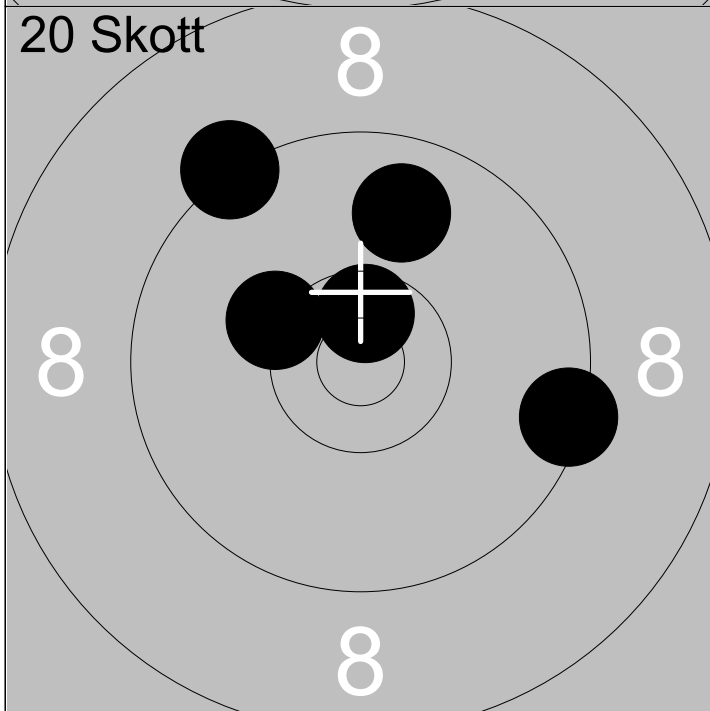

16:	9.8	↑
17:	9.3	↗
18:	10.6x	↑
19:	9.4	→
20:	10.3	↖

Serie 47

Total 190

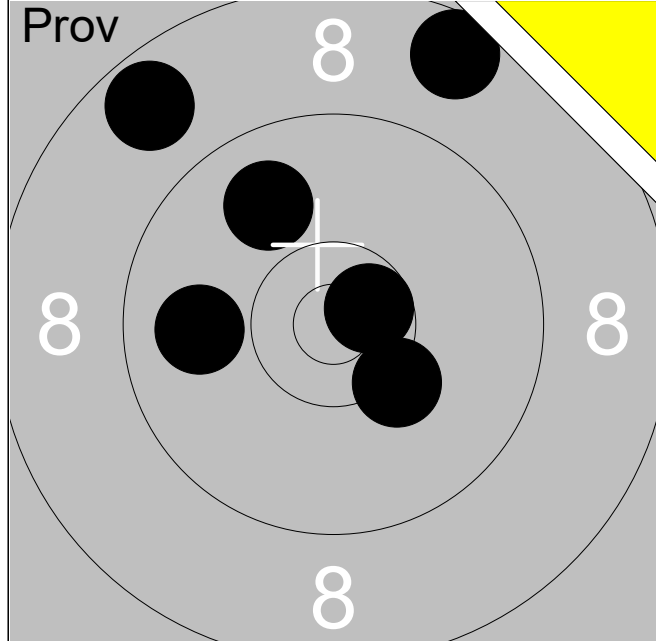

1:	8.6	↗
2:	10.3	↘
3:	9.9	←
4:	10.6x	↗
5:	8.7	↗
6:	9.9	↗

Serie	54
-------	-----------

Total	0
-------	----------

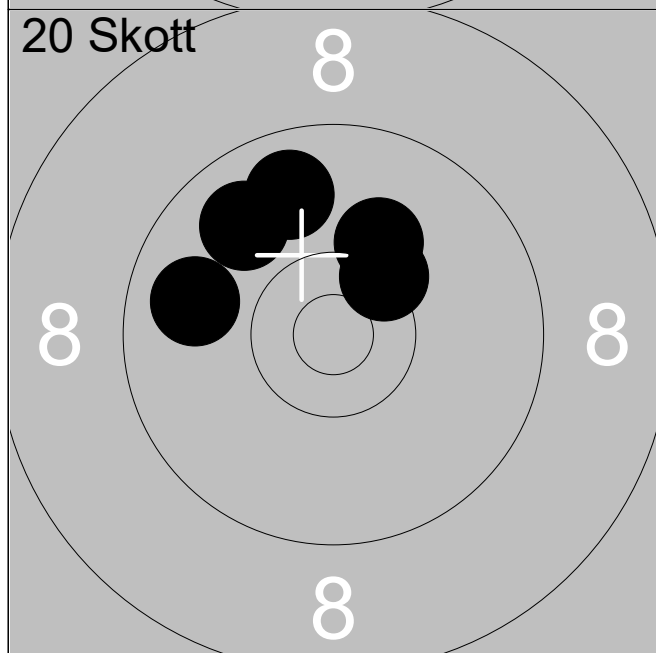

1:	9.8	↗
2:	10.3x	↗
3:	9.8	←
4:	9.8	↗
5:	10.1	↗

Serie	47
-------	-----------

Total	47
-------	-----------

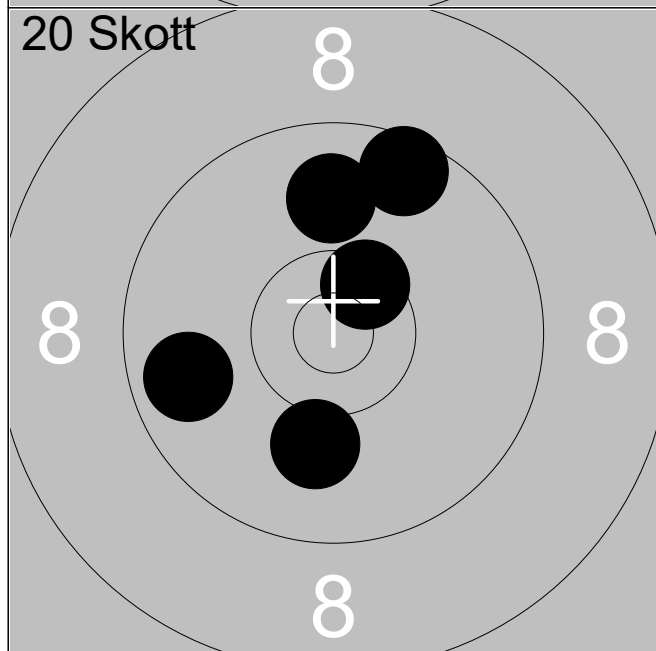

6:	9.6	↗
7:	9.9	↑
8:	9.8	←
9:	10.1	↘
10:	10.5x	↗

Serie	47
-------	-----------

Total	94
-------	-----------

20 Skott

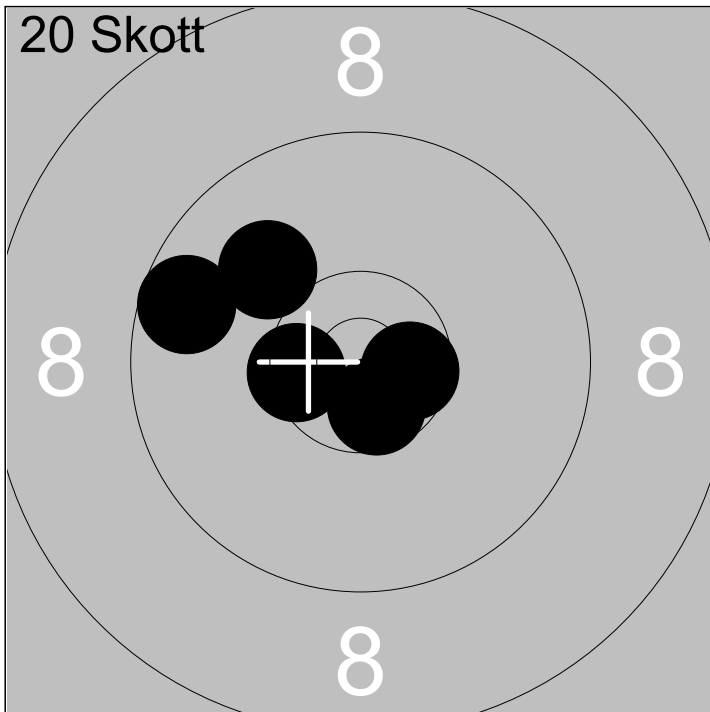

11:	10.0	↗
12:	10.5x	←
13:	10.6x	↘
14:	9.6	↖
15:	10.6x	↘

Serie 49

Total 143

20 Skott

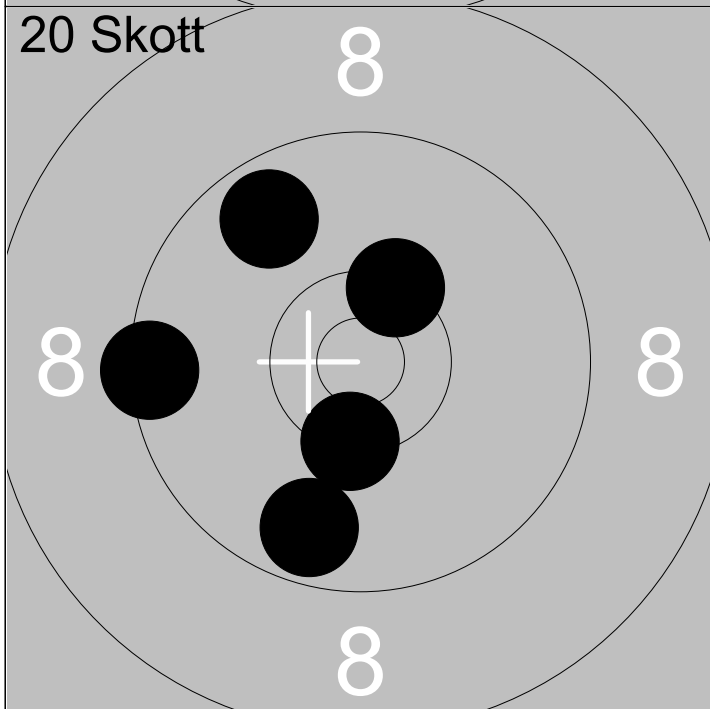

16:	9.7	↘
17:	9.4	←
18:	9.7	↗
19:	10.4x	↗
20:	10.4x	↘

Serie 47

Total 190

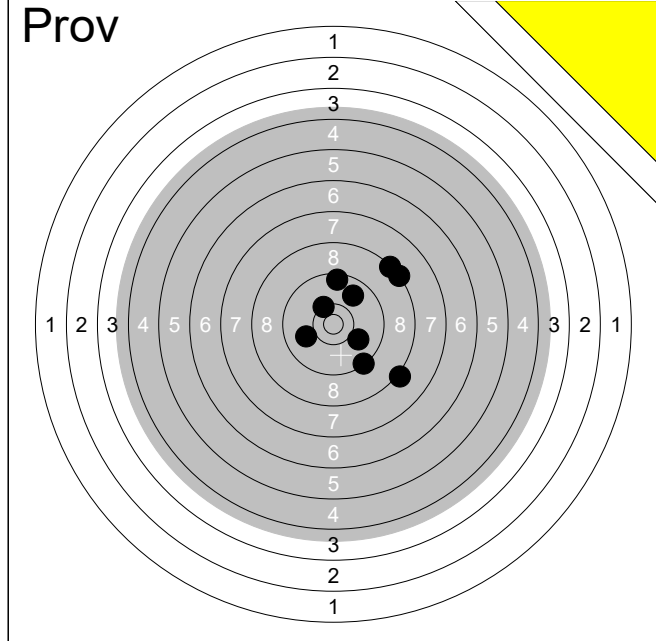

1:	0.0	↓
2:	8.3	↗
3:	10.3x	↗
4:	9.8	↗
5:	8.3	↗
6:	10.0	↘
7:	9.3	↘
8:	10.0	←
9:	9.5	↑
10:	8.2	↘
Serie		81
Total		0

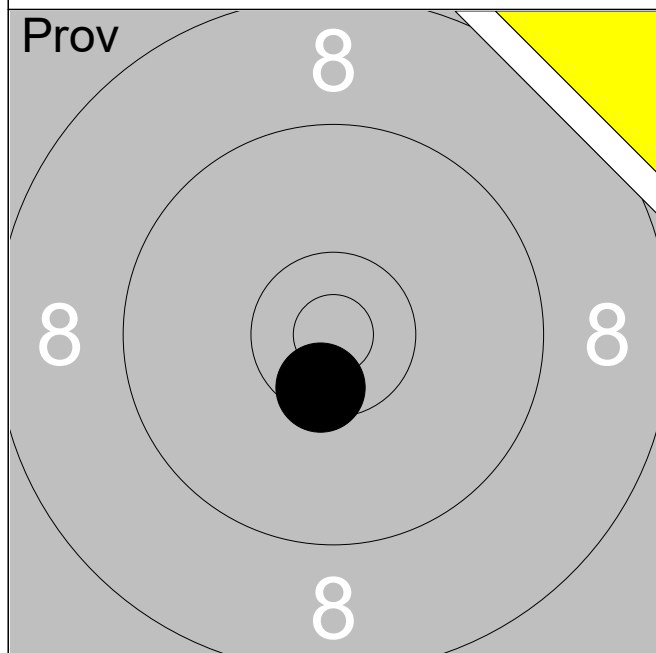

11:	10.5x	↓
Serie		10
Total		0

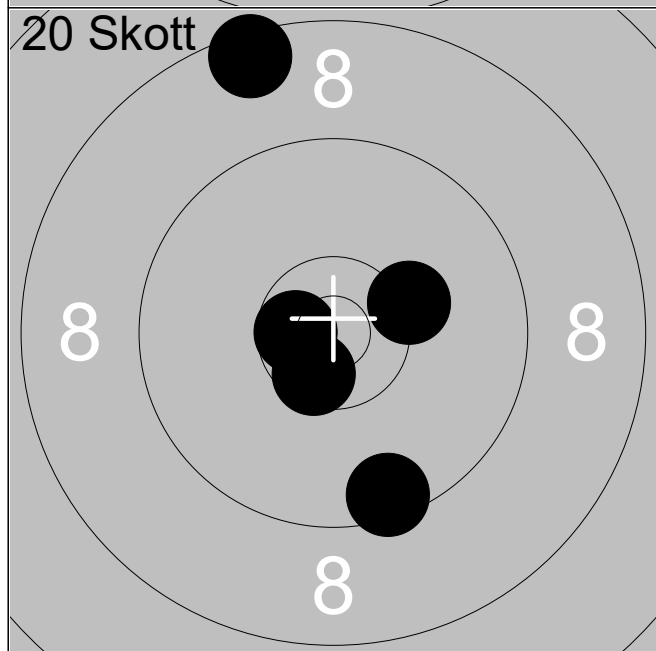

1:	10.6x	↘
2:	9.5	↘
3:	10.3	↗
4:	8.5	↑
5:	10.6x	←
Serie		47
Total		47

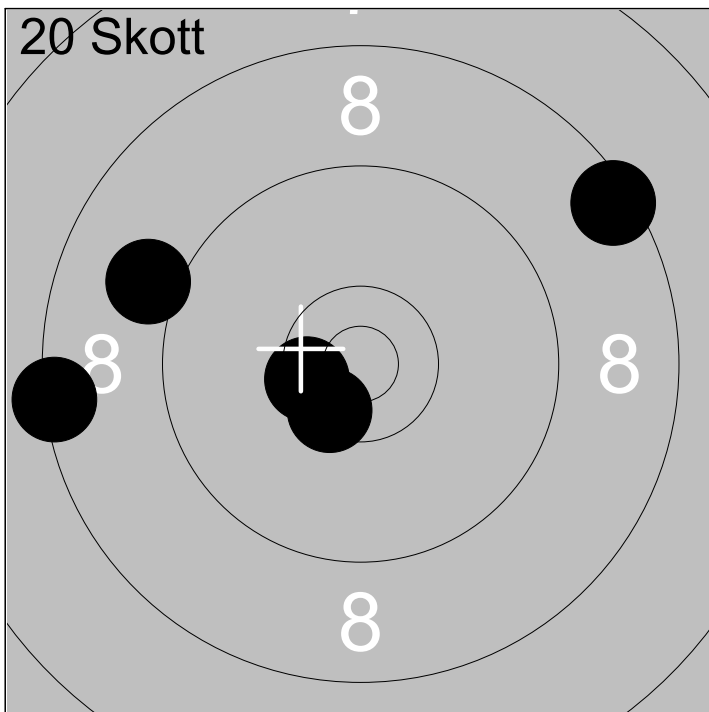

6:	10.5x	↙
7:	8.5	↗
8:	9.1	↖
9:	8.4	←
10:	10.5x	←

Serie 45

Total 92

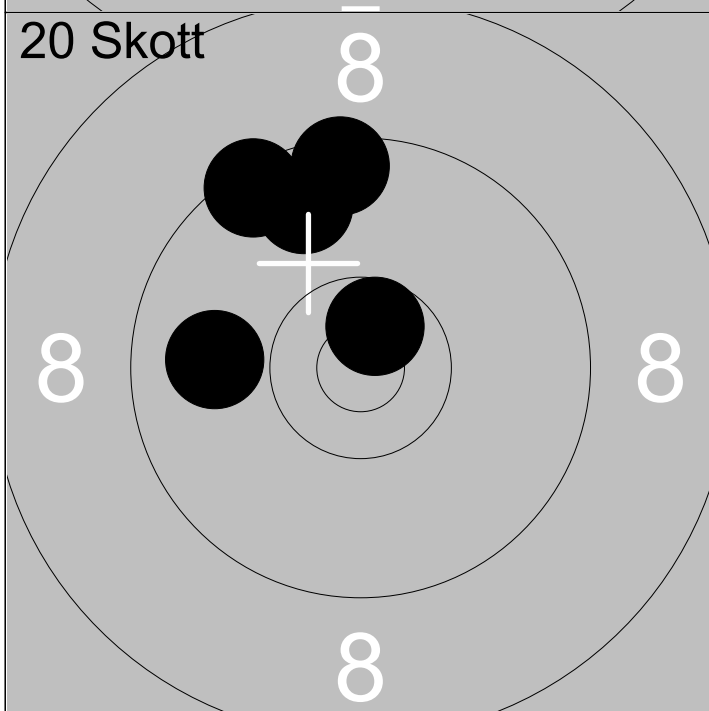

11:	9.4	↖
12:	10.6x	↗
13:	9.7	↖
14:	9.9	←
15:	9.5	↑

Serie 46

Total 138

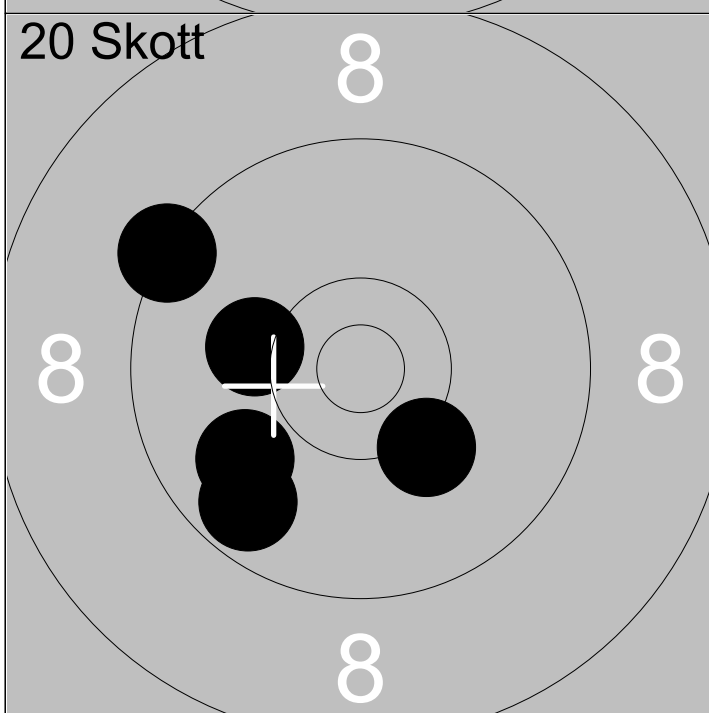

16:	9.3	↖
17:	10.2	←
18:	9.9	↖
19:	10.2	↘
20:	9.7	↘

Serie 47

Total 185

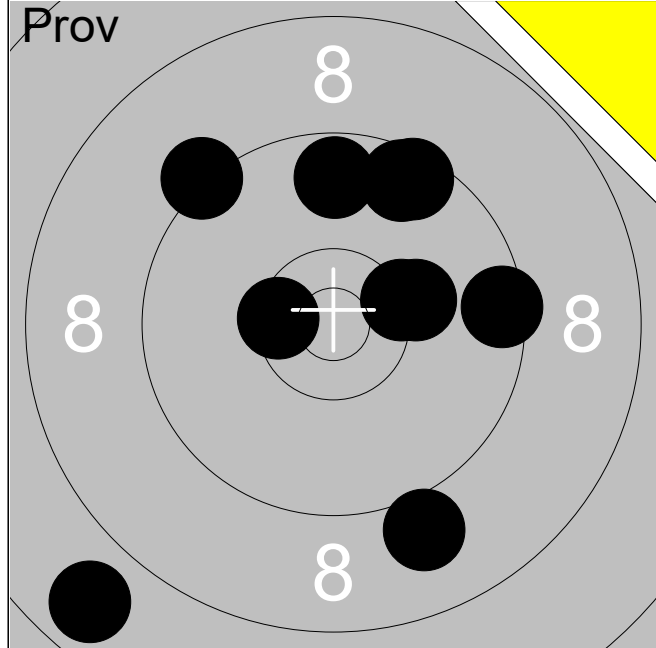

1:	7.8	↙
2:	9.0	↘
3:	9.5	→
4:	9.3	↗
5:	10.5x	←
6:	10.3x	→
7:	10.2	→
8:	9.6	↗
9:	9.5	↗
10:	9.7	↑

Serie	91
-------	-----------

Total	0
-------	----------

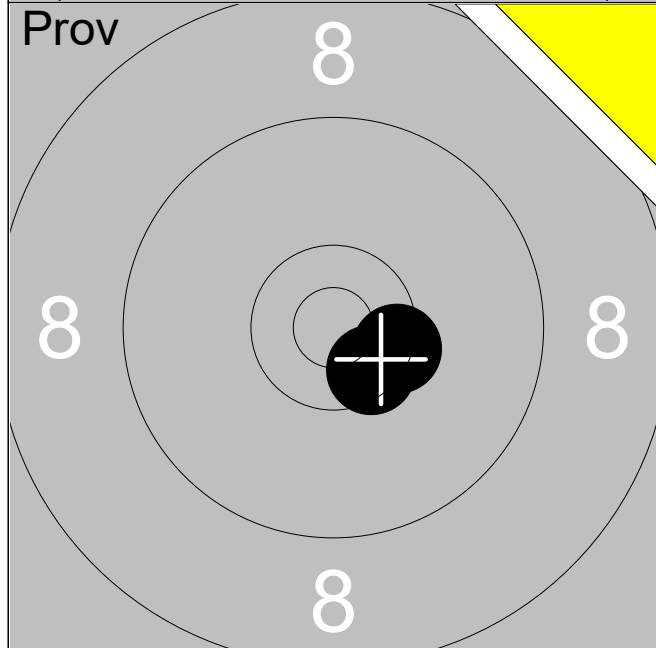

11:	10.5x	↘
12:	10.4x	→

Serie	20
-------	-----------

Total	0
-------	----------

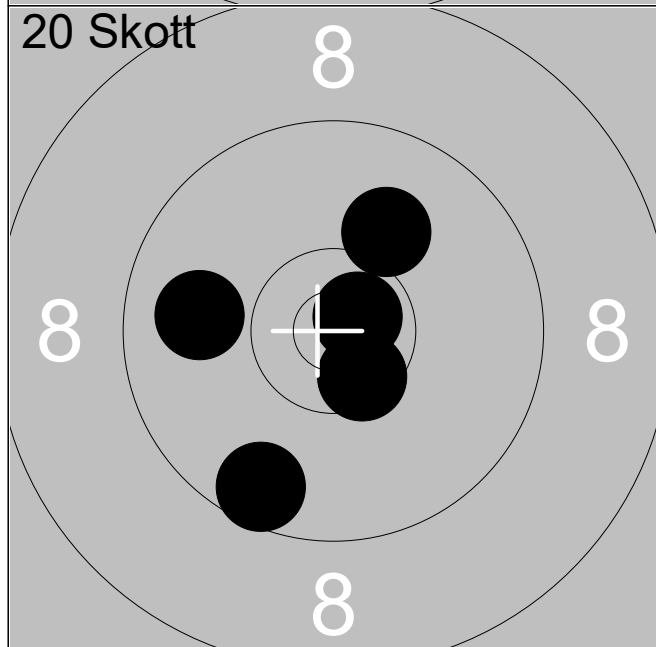

1:	10.7x	↗
2:	9.6	↘
3:	10.1	↗
4:	10.5x	↘
5:	9.9	←

Serie	48
-------	-----------

Total	48
-------	-----------

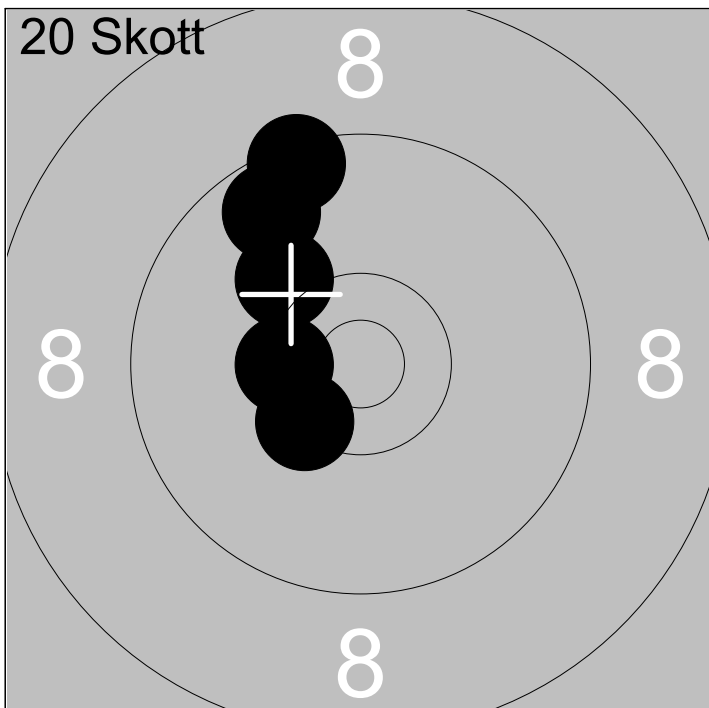

6:	9.4	↗
7:	10.4x	↘
8:	10.1	↗
9:	9.7	↗
10:	10.4x	↖

Serie	48
Total	96

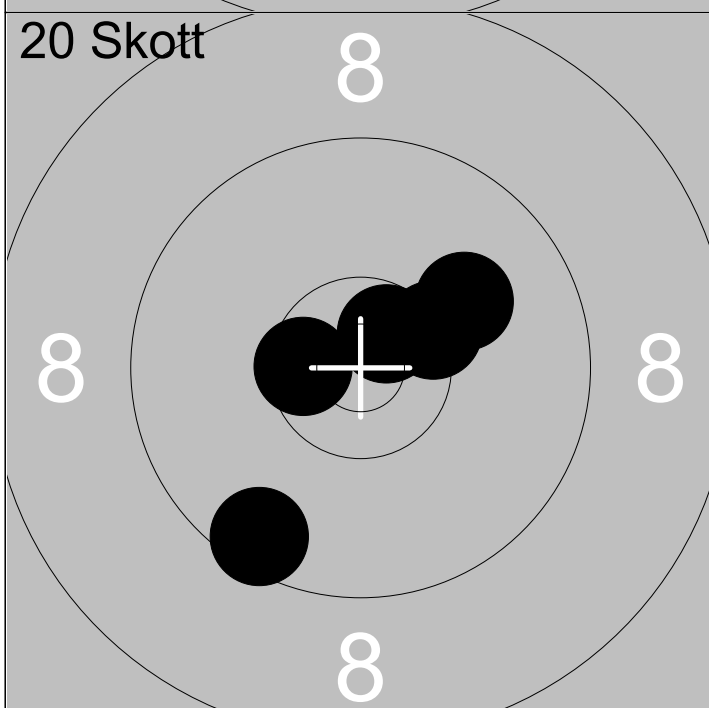

11:	10.6x	↗
12:	9.5	↘
13:	10.4x	↗
14:	10.5x	↖
15:	10.1	↗

Serie	49
Total	145

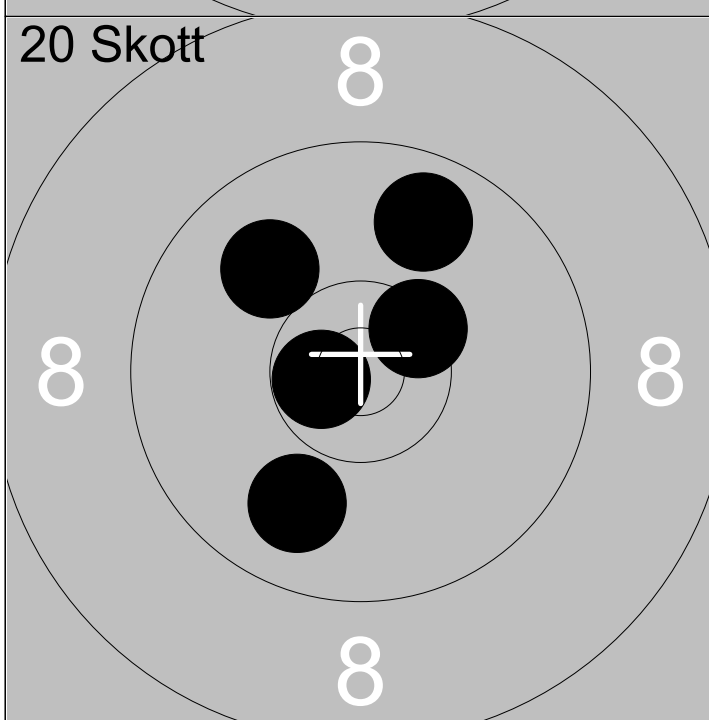

16:	9.8	↗
17:	9.9	↘
18:	10.0	↗
19:	10.7x	↖
20:	10.4x	↗

Serie	48
Total	193

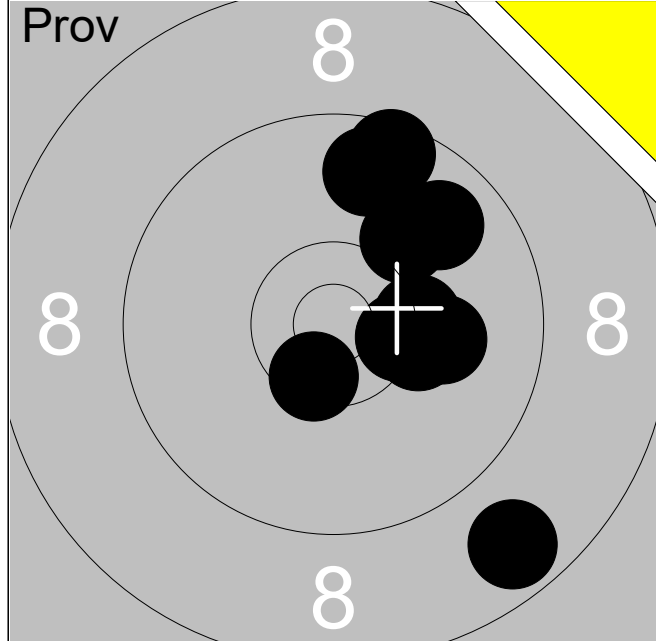

1:	9.5	↗
2:	8.7	↘
3:	10.5x	↘
4:	10.3	→
5:	9.8	↗
6:	10.1	↗
7:	10.3x	→
8:	9.7	↑
9:	10.1	→
10:	10.4x	→

Serie	95
-------	-----------

Total	0
-------	----------

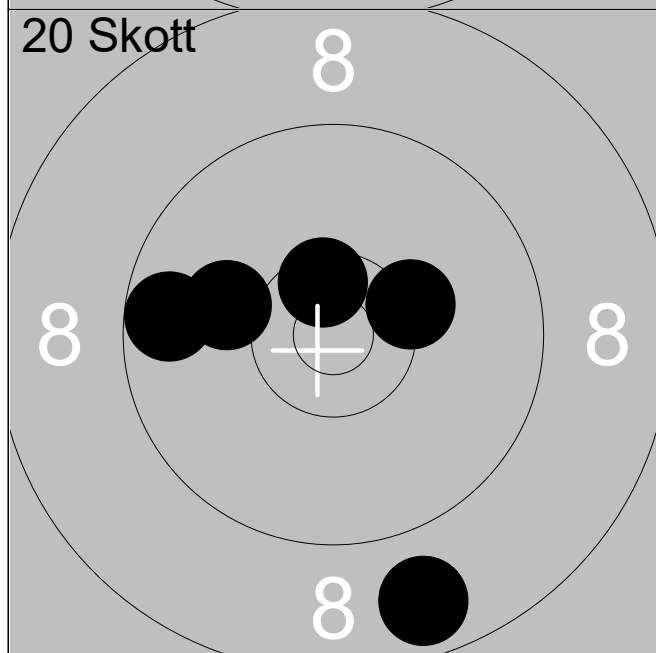

1:	8.7	↘
2:	10.3x	→
3:	10.1	←
4:	9.7	←
5:	10.5x	↑

Serie	47
-------	-----------

Total	47
-------	-----------

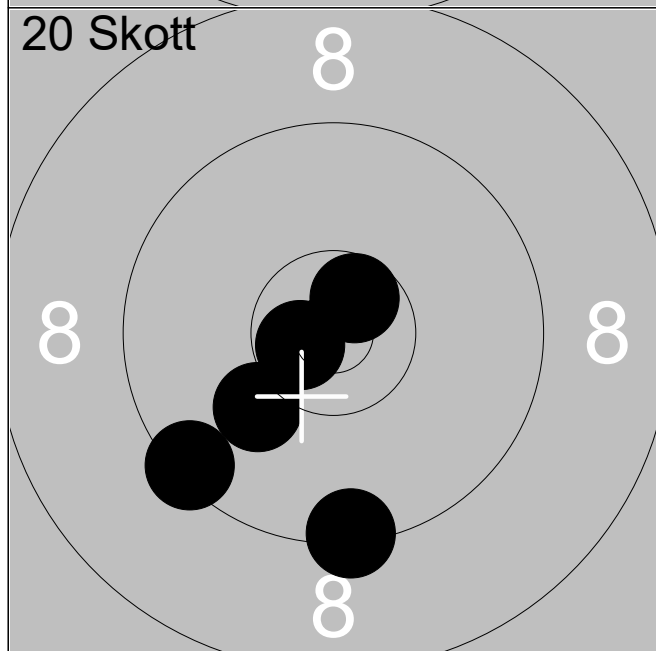

6:	9.4	↙
7:	10.7x	←
8:	10.1	↙
9:	10.6x	↗
10:	9.4	↘

Serie	48
-------	-----------

Total	95
-------	-----------

20 Skott

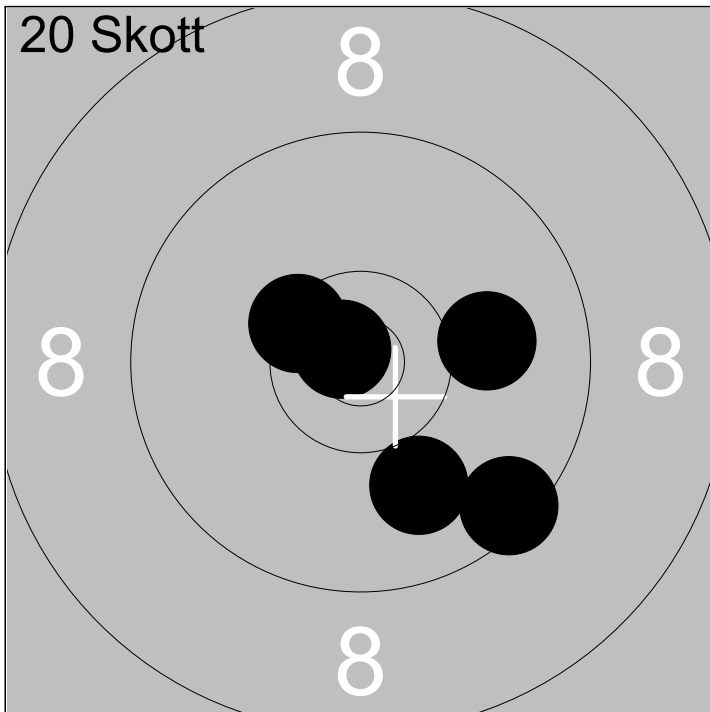

11:	9.5	↘
12:	10.0	→
13:	10.0	↘
14:	10.4x	↗
15:	10.8x	↗

Serie 49

Total 144

20 Skott

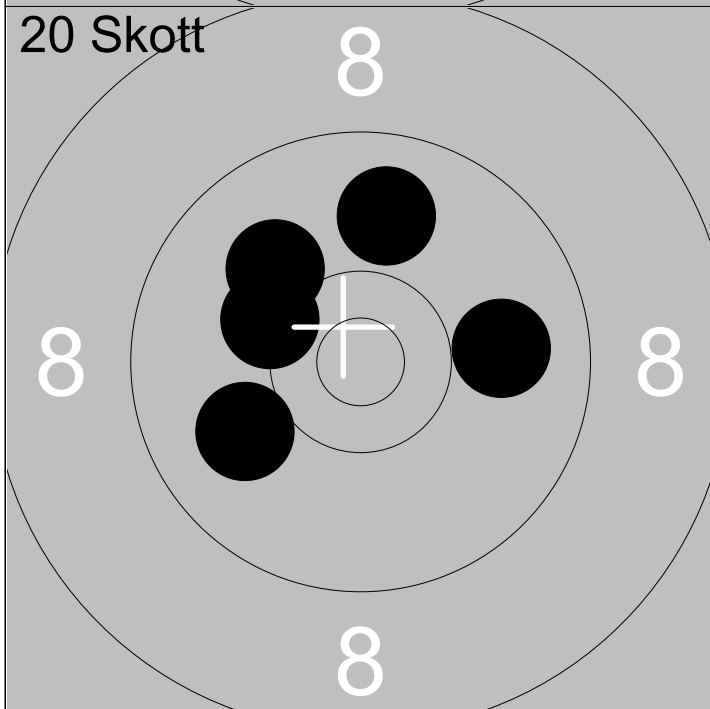

16:	10.2	↖
17:	10.0	↖
18:	10.0	↗
19:	9.9	→
20:	9.9	↑

Serie 48

Total 192

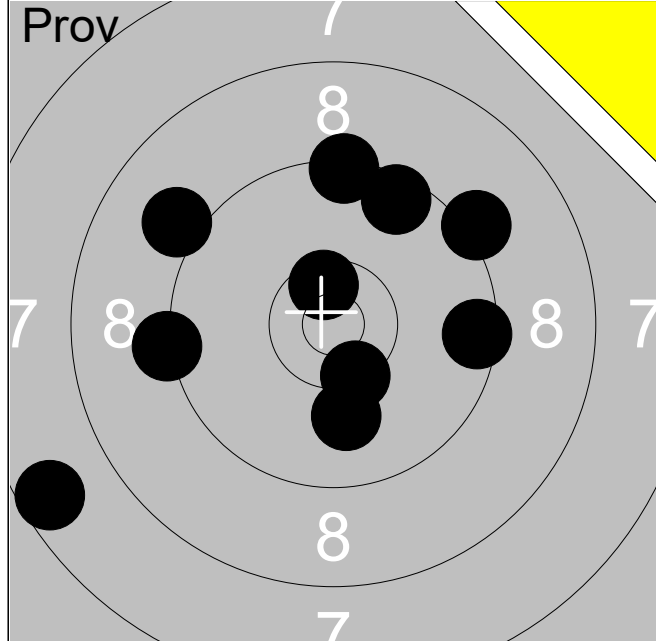

1:	7.6	↙
2:	9.1	↖
3:	9.2	↗
4:	9.4	↑
5:	9.5	↗
6:	9.5	→
7:	10.0	↓
8:	10.4x	↓
9:	10.5x	↑
10:	9.3	←

Serie	91
-------	-----------

Total	0
-------	----------

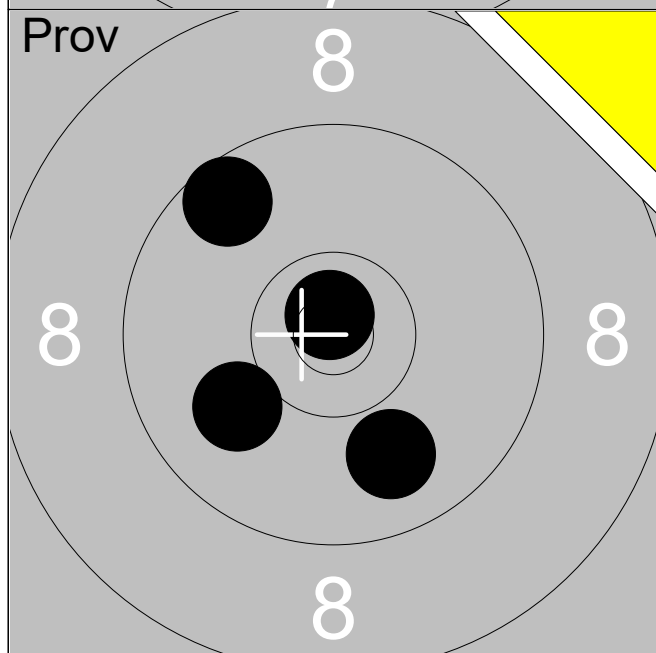

11:	9.9	↓
12:	10.0	↙
13:	9.6	↗
14:	10.8x	↑

Serie	38
-------	-----------

Total	0
-------	----------

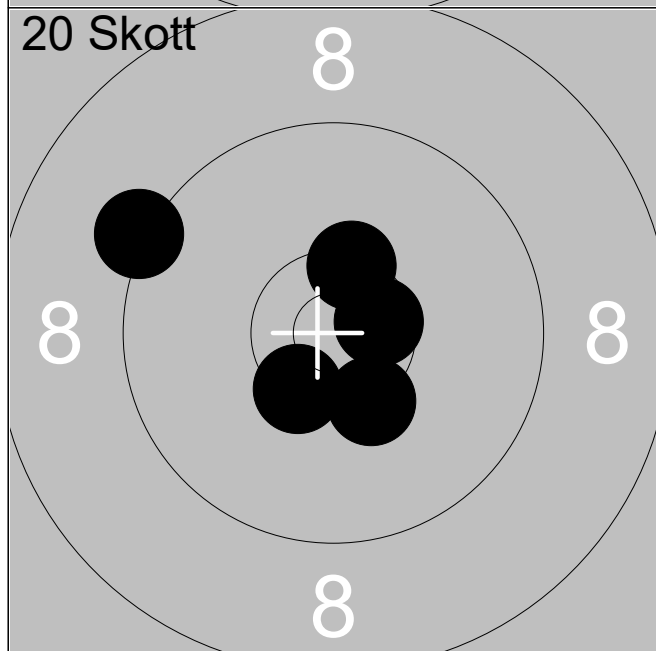

1:	10.4x	↑
2:	10.4x	↙
3:	10.3x	↓
4:	10.6x	→
5:	9.2	↖

Serie	49
-------	-----------

Total	49
-------	-----------

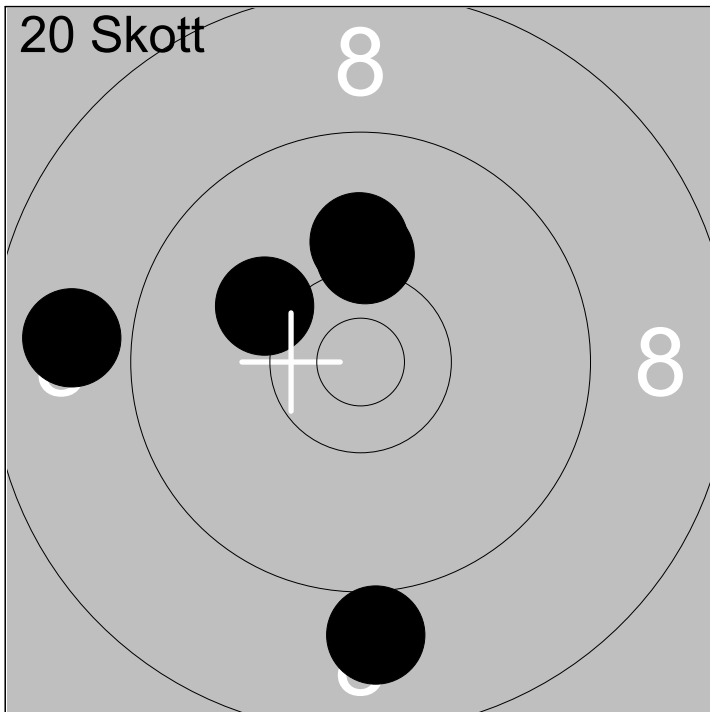

6:	9.0	↓
7:	10.2	↑
8:	8.9	←
9:	10.2	↗
10:	10.1	↑

Serie	47
Total	96

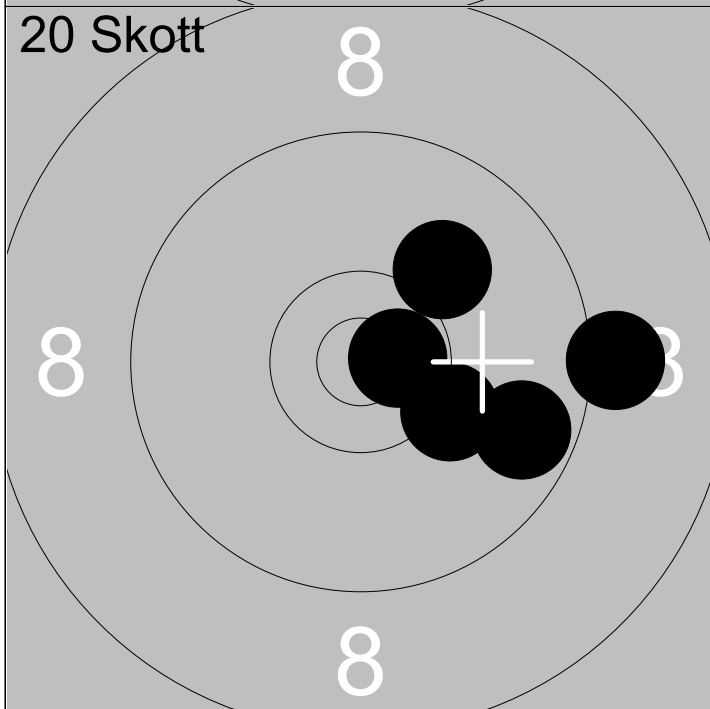

11:	9.7	↘
12:	10.2	↘
13:	9.1	→
14:	10.1	↗
15:	10.7x	→

Serie	48
Total	144

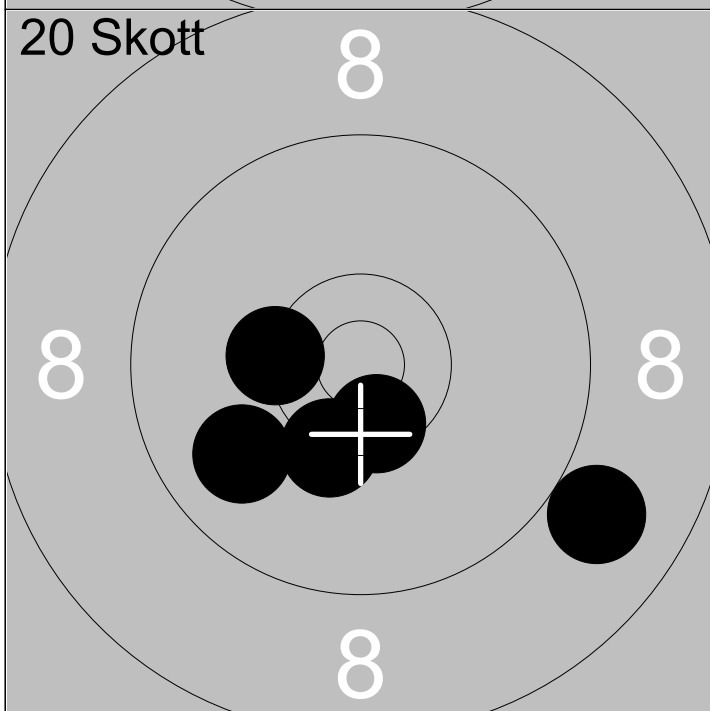

16:	9.9	↙
17:	10.5x	↓
18:	10.3x	↓
19:	10.3x	←
20:	8.9	↘

Serie	47
Total	191

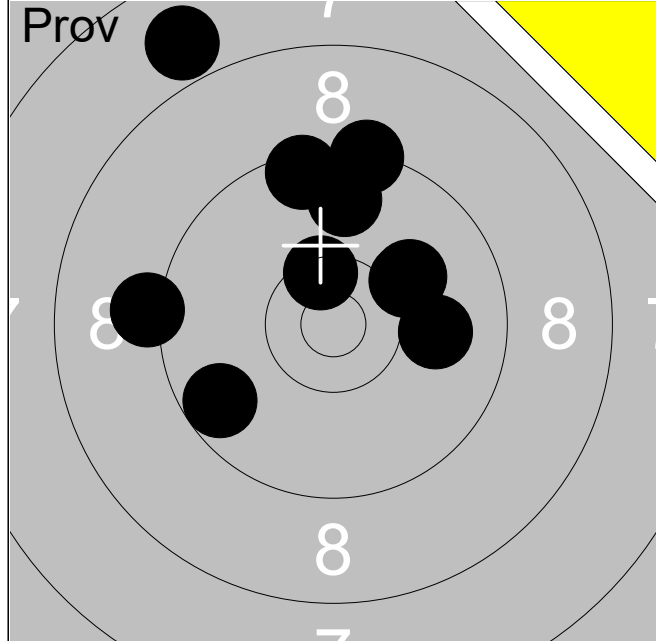

1:	9.2	←
2:	10.0	→
3:	9.6	↙
4:	9.3	↑
5:	10.1	↗
6:	10.1	↗
7:	10.4x	↑
8:	9.5	↑
9:	7.9	↖
10:	9.8	↑

Serie	92
--------------	-----------

Total	0
--------------	----------

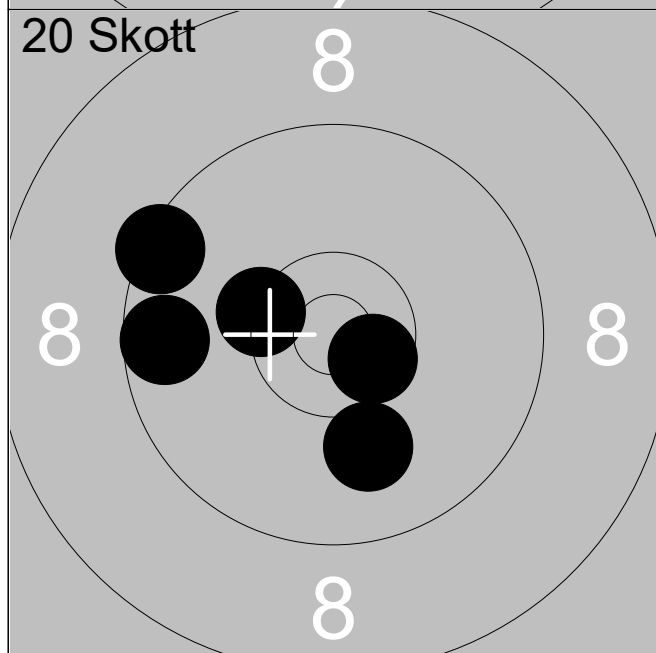

1:	10.4x	←
2:	10.0	↓
3:	9.4	↗
4:	9.6	←
5:	10.6x	↘

Serie	48
--------------	-----------

Total	48
--------------	-----------

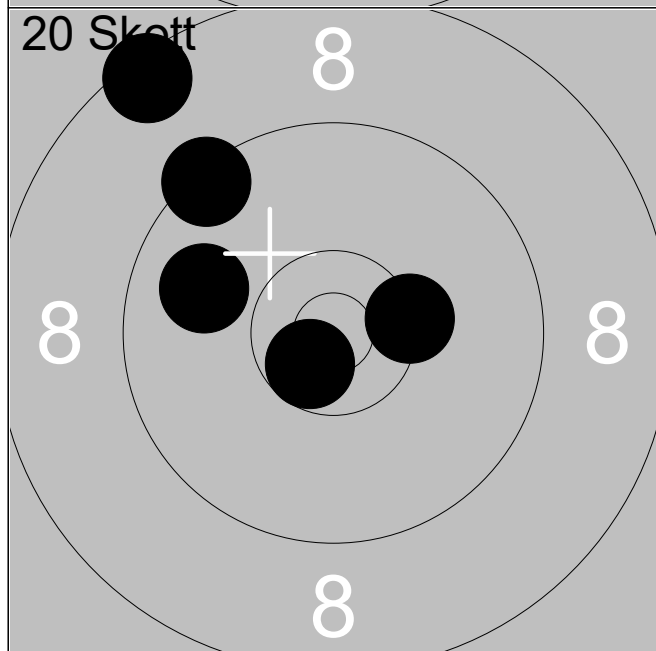

6:	9.4	↗
7:	9.9	←
8:	10.3x	→
9:	10.6x	↘
10:	8.5	↗

Serie	46
--------------	-----------

Total	94
--------------	-----------

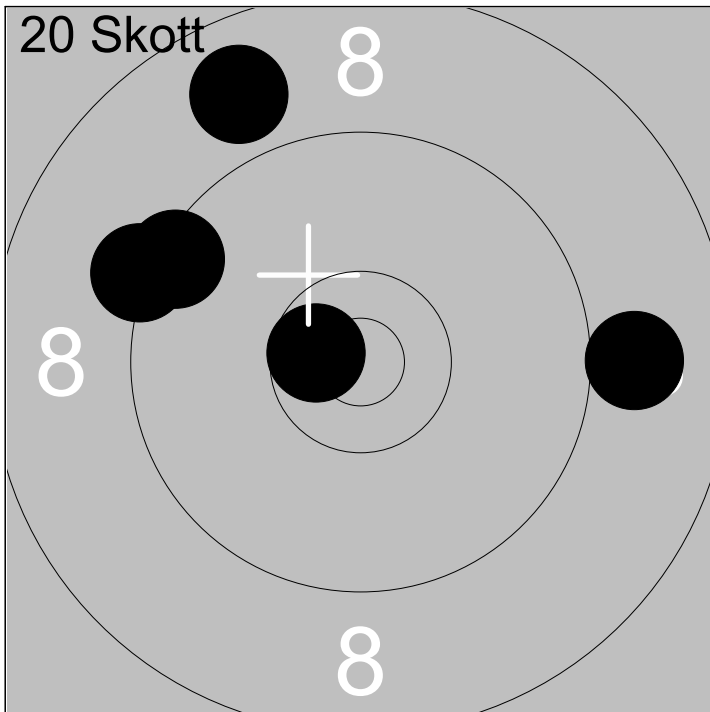

11:	9.2	↖
12:	8.8	↗
13:	9.4	↖
14:	9.0	→
15:	10.6x	↖

Serie 45

Total 139

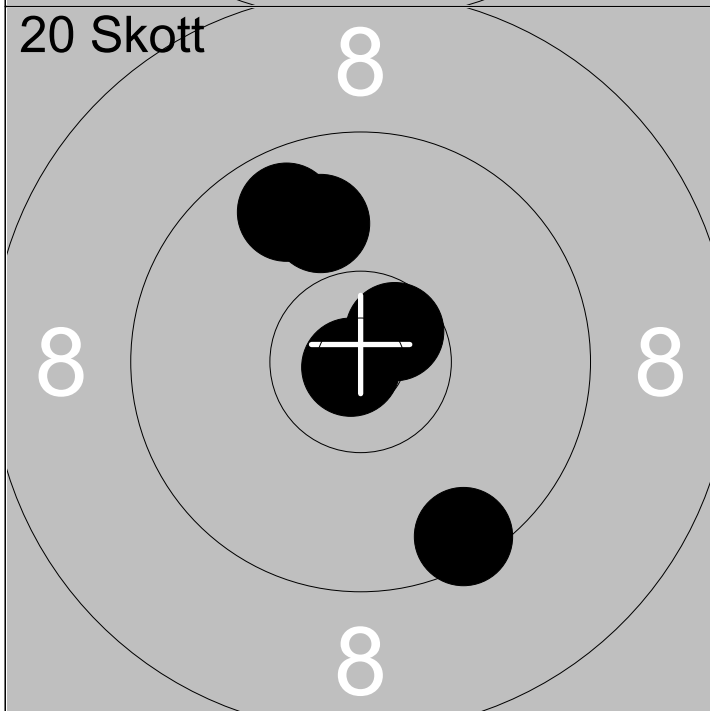

16:	9.9	↑
17:	10.6x	↗
18:	9.5	↘
19:	10.9x	↖
20:	9.8	↗

Serie 47

Total 186

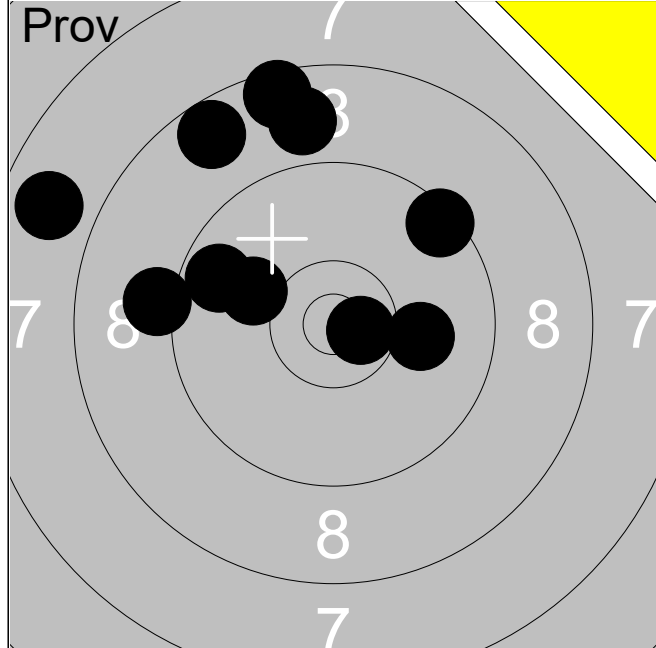

1:	7.8	↖
2:	8.8	↑
3:	10.1	↖
4:	8.5	↑
5:	8.6	↗
6:	9.5	↗
7:	9.7	↖
8:	9.1	↖
9:	10.1	→
10:	10.7x	→

Serie	88
-------	-----------

Total	0
-------	----------

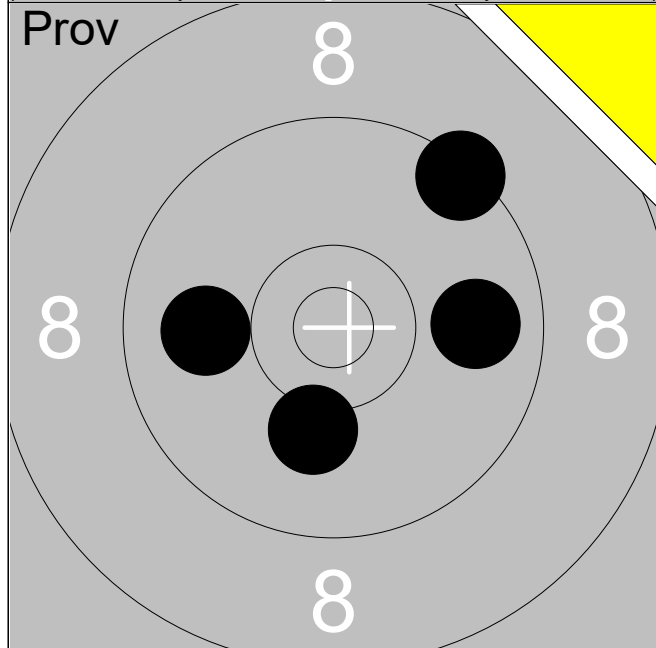

11:	10.1	↓
12:	9.4	↗
13:	9.8	→
14:	9.9	↖

Serie	37
-------	-----------

Total	0
-------	----------

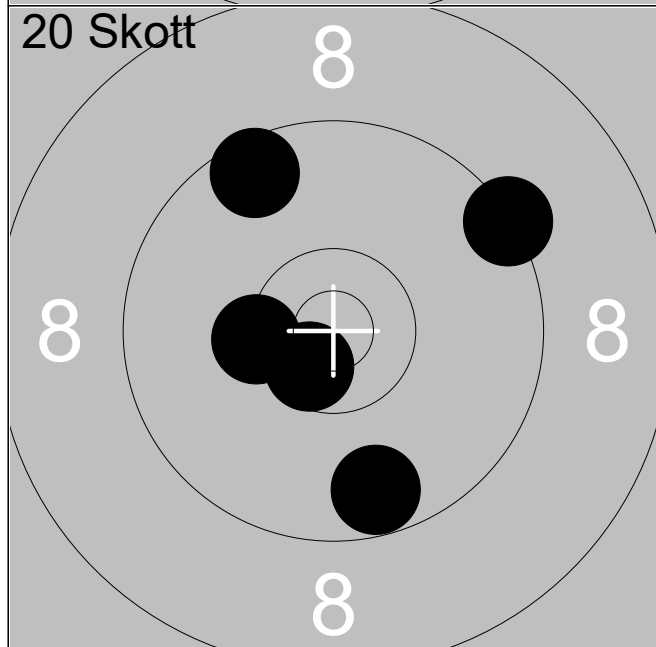

1:	9.3	↗
2:	9.6	↗
3:	9.7	↓
4:	10.6x	↘
5:	10.3x	↖

Serie	47
-------	-----------

Total	47
-------	-----------

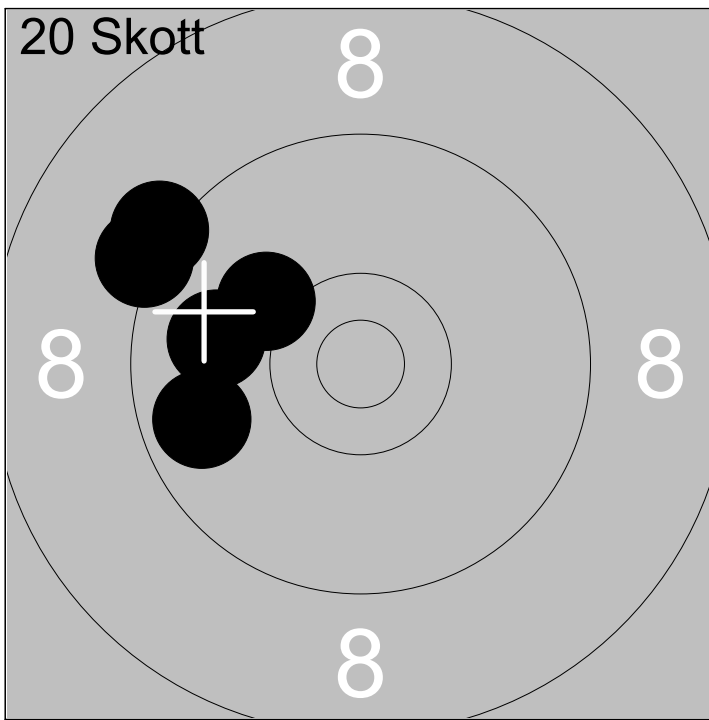

6:	10.1	↗
7:	9.2	↖
8:	9.2	↗
9:	9.7	↖
10:	9.9	↖

Serie	46
Total	93

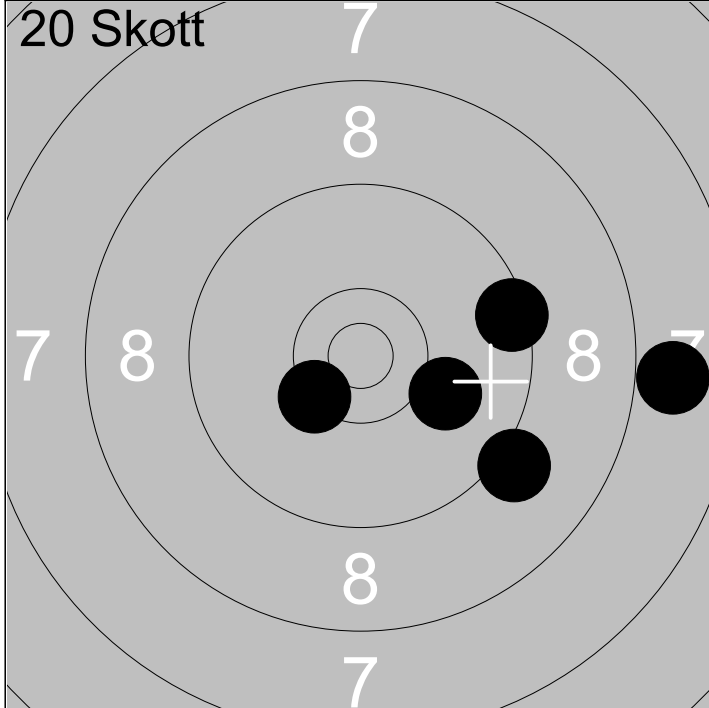

11:	10.4x	↖
12:	7.9	→
13:	10.1	↘
14:	9.1	↘
15:	9.4	→

Serie	45
Total	138

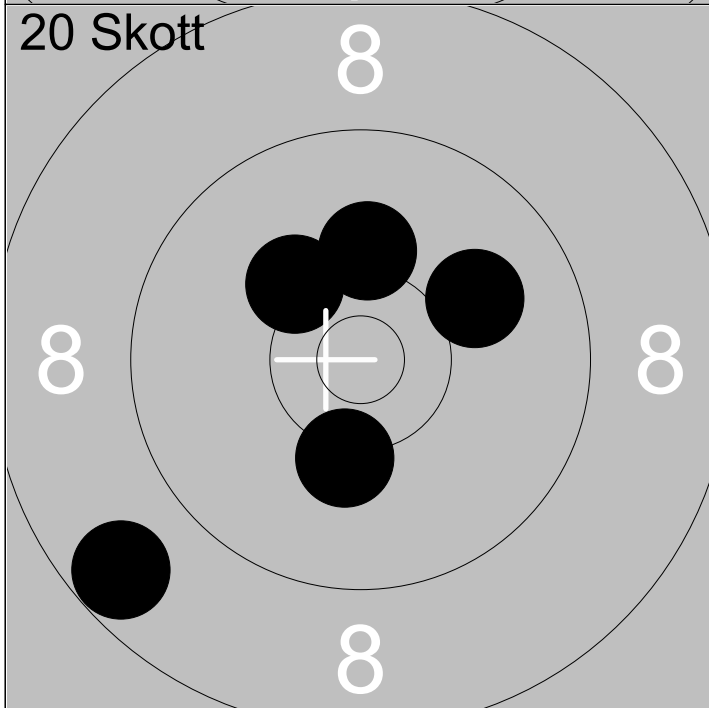

16:	10.0	↗
17:	10.2	↑
18:	10.2	↗
19:	8.7	↖
20:	10.2	↓

Serie	48
Total	186

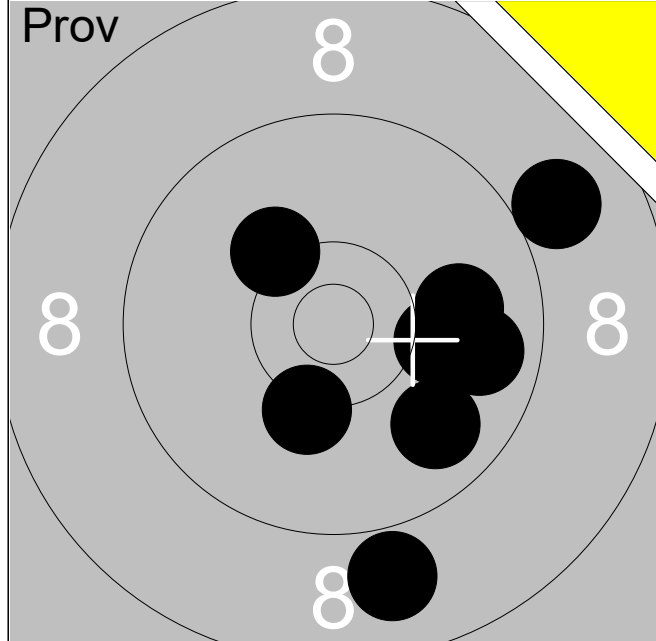

1:	8.9	↓
2:	10.0	→
3:	9.0	↗
4:	10.0	→
5:	10.2	↓
6:	9.8	↓
7:	9.8	→
8:	10.1	→
9:	10.2	↗
10:	9.8	→

Serie	94
-------	-----------

Total	0
-------	----------

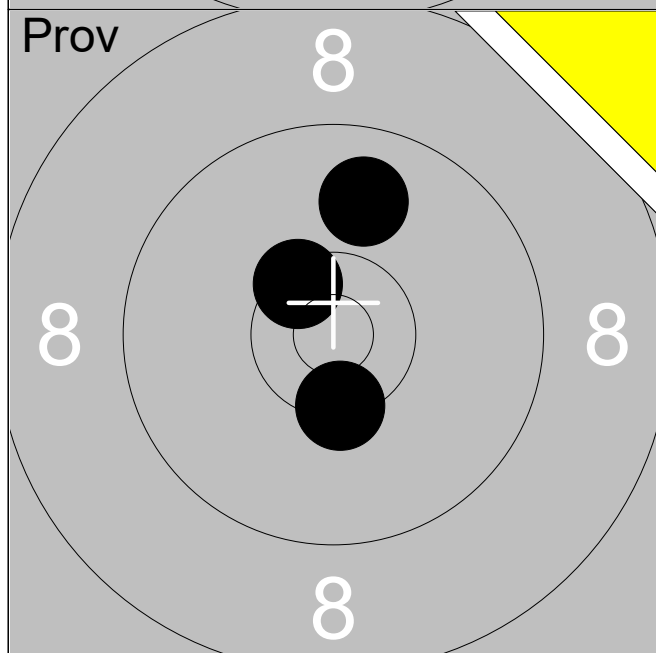

11:	10.5x	↗
12:	9.9	↑
13:	10.4x	↓

Serie	29
-------	-----------

Total	0
-------	----------

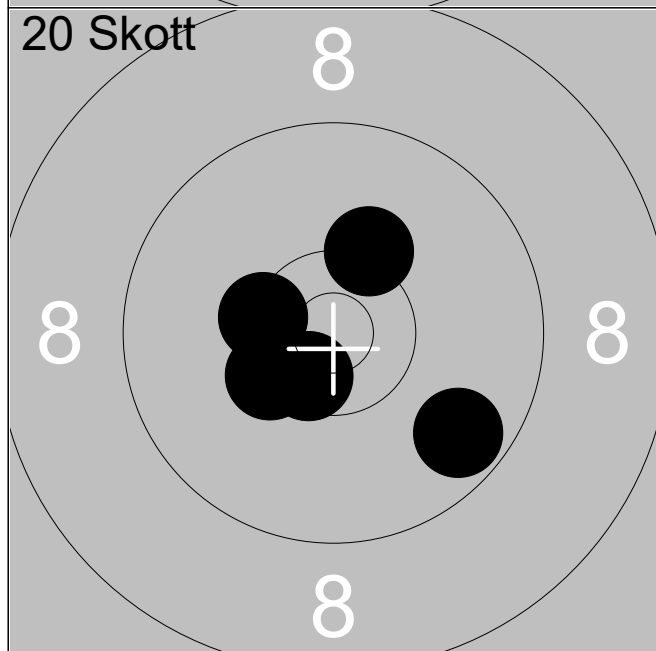

1:	9.7	↘
2:	10.2	↑
3:	10.6x	↓
4:	10.4x	↙
5:	10.4x	←

Serie	49
-------	-----------

Total	49
-------	-----------

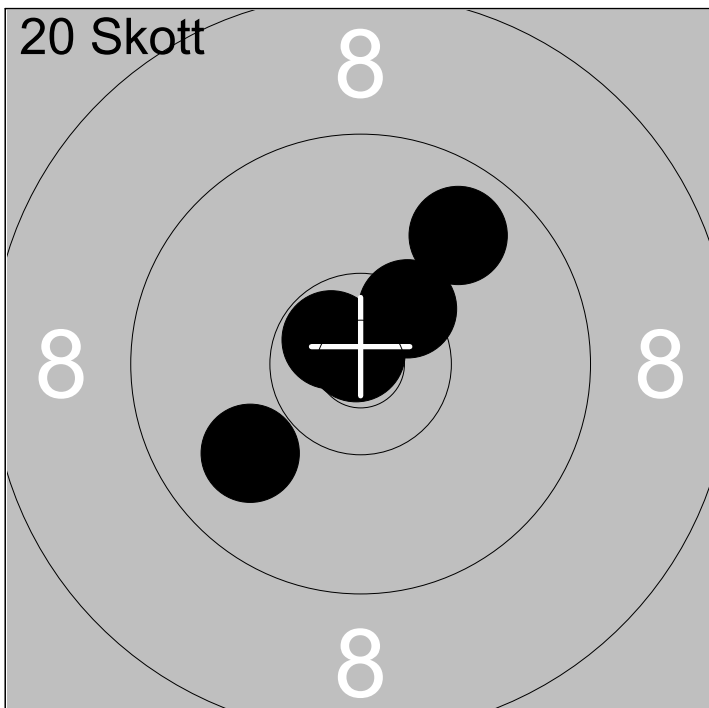

6:	10.4x	↗
7:	9.8	↗
8:	9.9	↖
9:	10.7x	↗
10:	10.9x	↗

Serie	48
Total	97

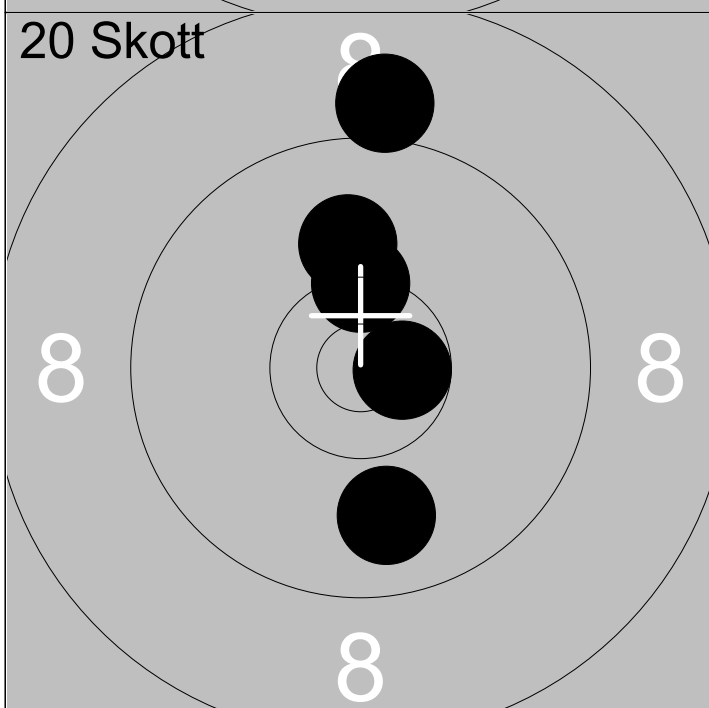

11:	9.0	↑
12:	10.1	↑
13:	10.3x	↑
14:	9.9	↓
15:	10.7x	→

Serie	48
Total	145

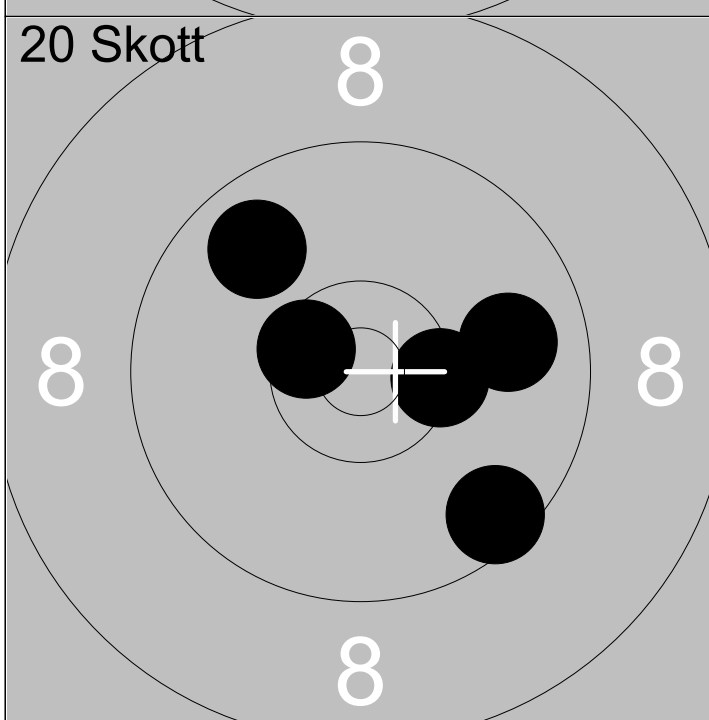

16:	10.4x	→
17:	9.9	→
18:	9.8	↗
19:	10.5x	↖
20:	9.5	↘

Serie	47
Total	192

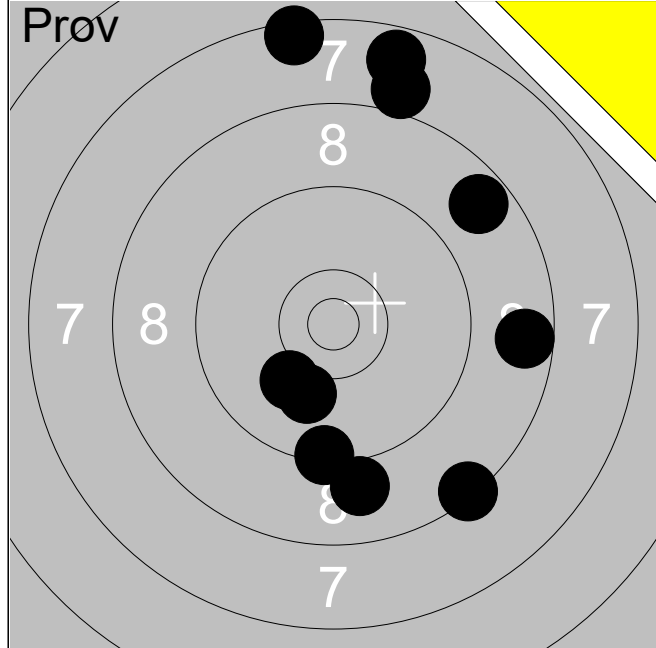

1:	7.5	↑
2:	8.0	↑
3:	7.7	↑
4:	8.7	↗
5:	8.7	→
6:	8.4	↘
7:	9.4	↓
8:	10.1	↓
9:	10.1	↙
10:	9.0	↓

Serie	84
-------	-----------

Total	0
-------	----------

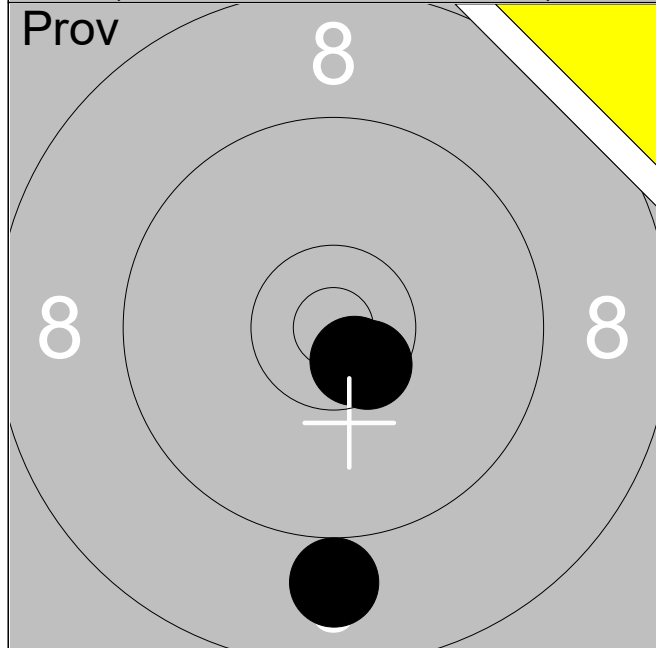

11:	10.6x	↘
12:	10.6x	↘
13:	9.0	↓

Serie	29
-------	-----------

Total	0
-------	----------

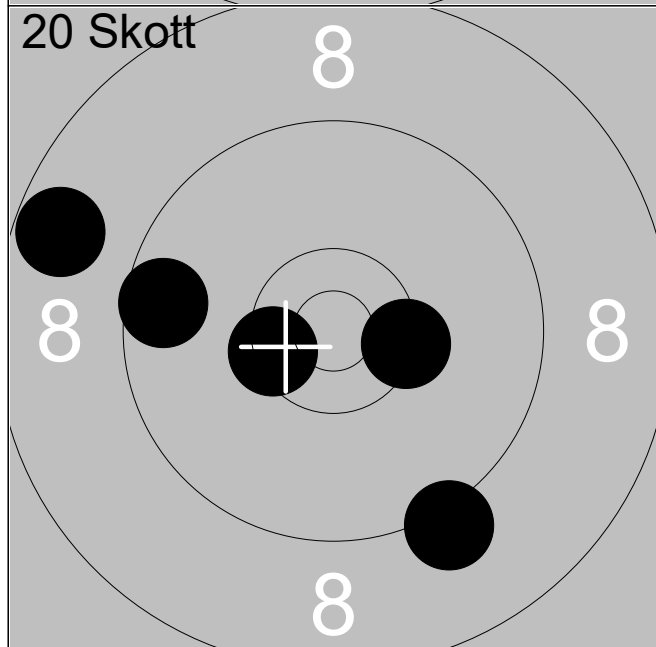

1:	10.4x	→
2:	9.2	↘
3:	10.4x	←
4:	9.6	←
5:	8.7	←

Serie	46
-------	-----------

Total	46
-------	-----------

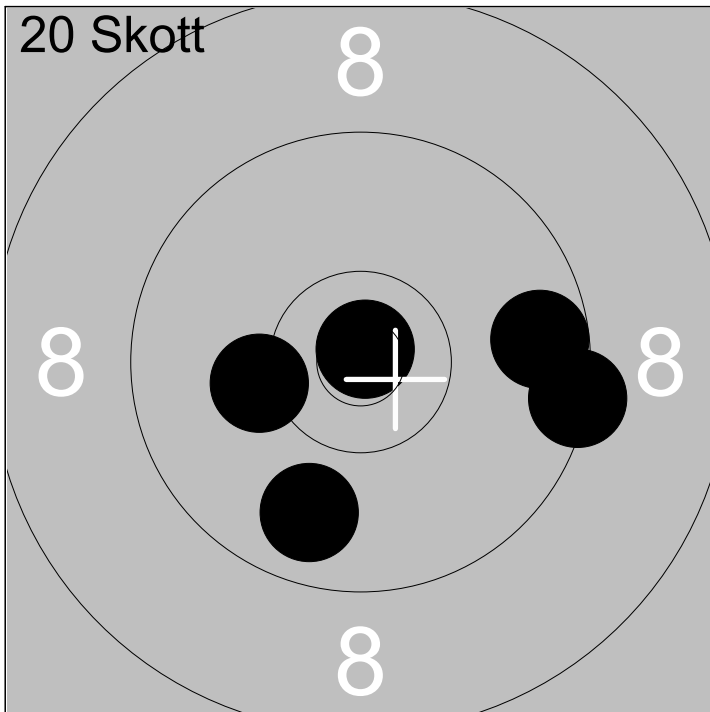

6:	9.8	↘
7:	10.2	←
8:	10.9x	↑
9:	9.4	→
10:	9.7	→

Serie 47

Total 93

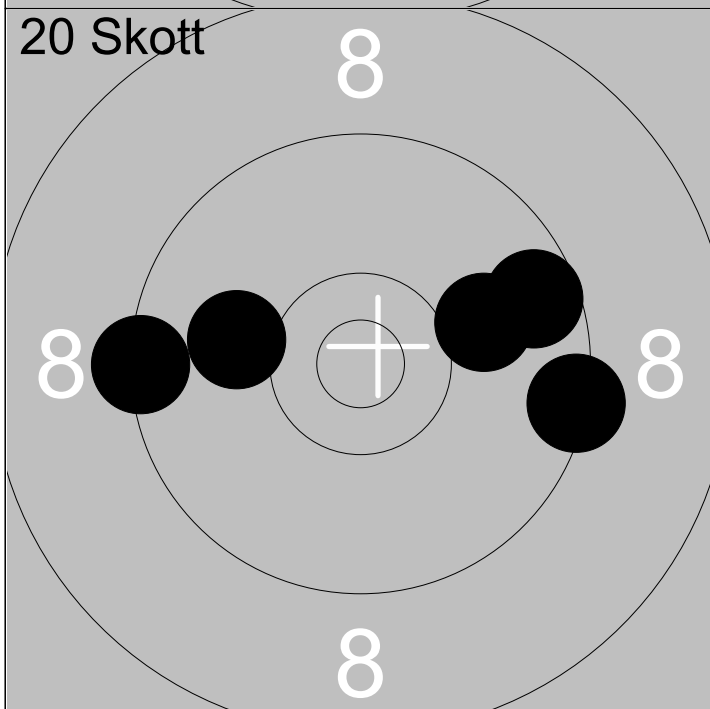

11:	9.4	→
12:	9.6	→
13:	10.0	←
14:	10.0	→
15:	9.4	←

Serie 47

Total 140

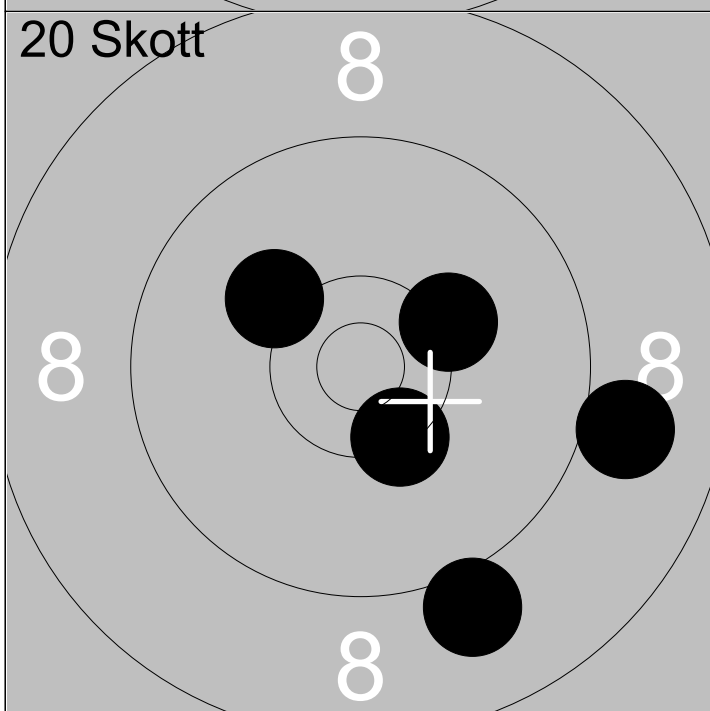

16:	10.2	↗
17:	9.0	→
18:	9.0	↘
19:	10.4x	↘
20:	10.2	↗

Serie 48

Total 188

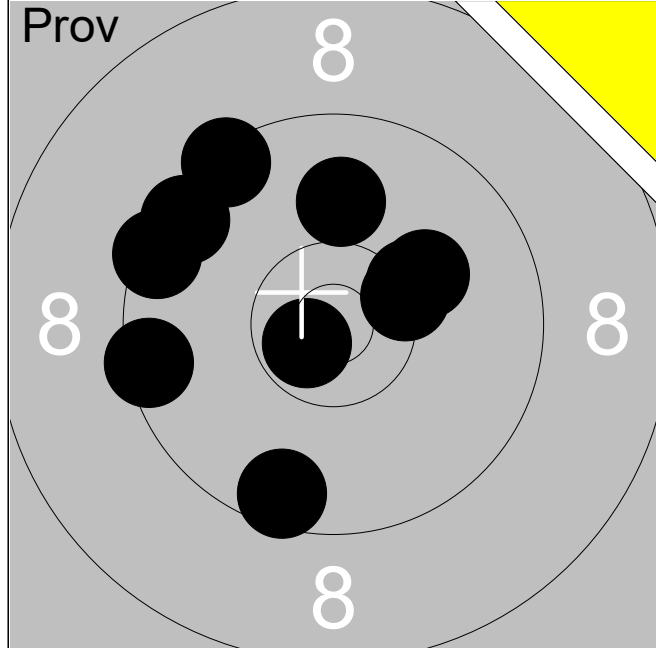

1:	9.6	↓
2:	9.5	←
3:	10.3x	→
4:	9.5	↖
5:	10.0	↑
6:	9.4	↗
7:	9.5	↖
8:	10.7x	↙
9:	10.3	→
10:	10.1	↗

Serie	95
-------	-----------

Total	0
-------	----------

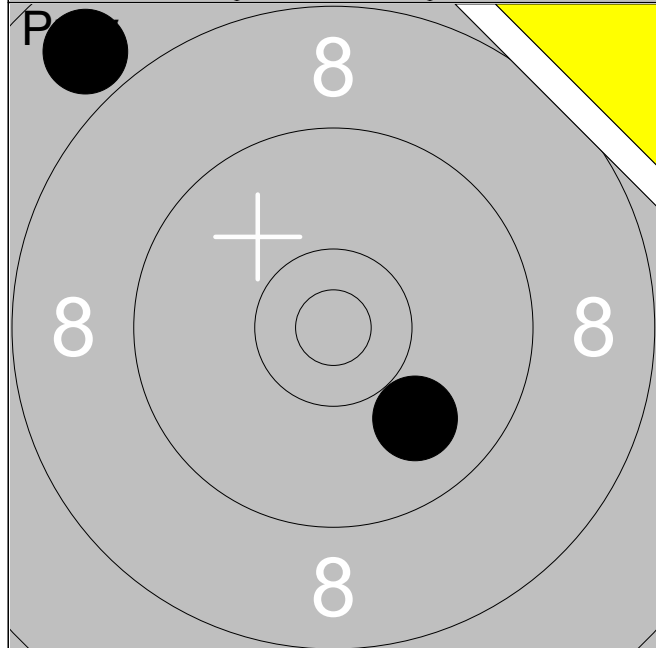

11:	7.9	↗
12:	9.9	↘

Serie	16
-------	-----------

Total	0
-------	----------

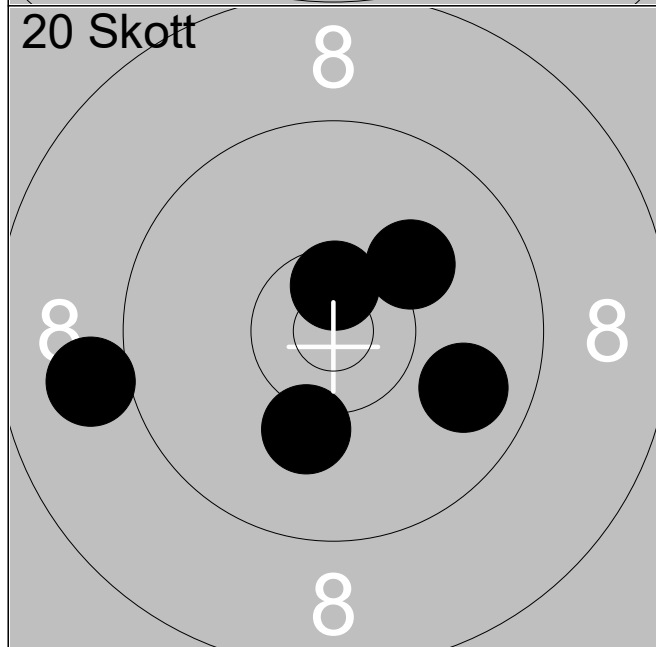

1:	10.6x	↑
2:	10.1	↗
3:	9.8	→
4:	10.2	↓
5:	9.0	←

Serie	48
-------	-----------

Total	48
-------	-----------

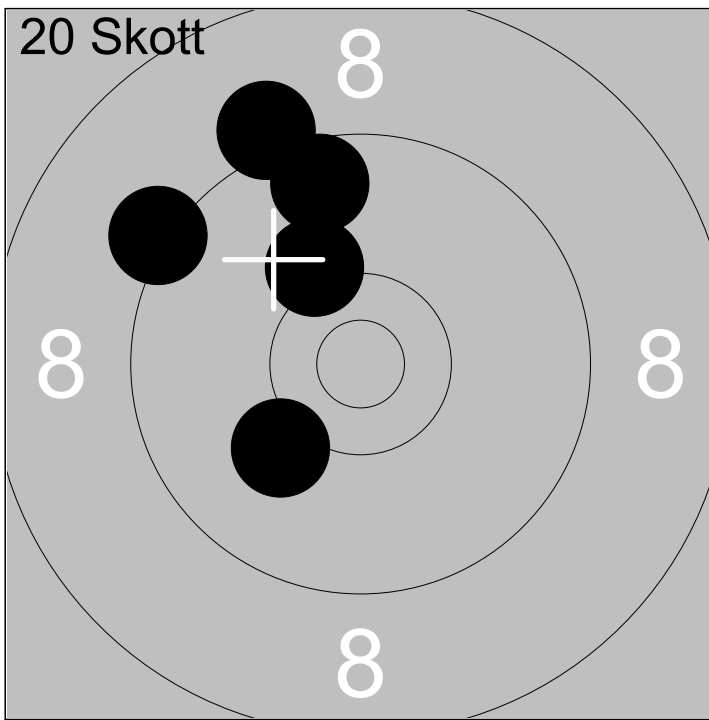

6:	10.2	↗
7:	9.2	↖
8:	9.6	↑
9:	10.1	↙
10:	9.1	↗

Serie	47
Total	95

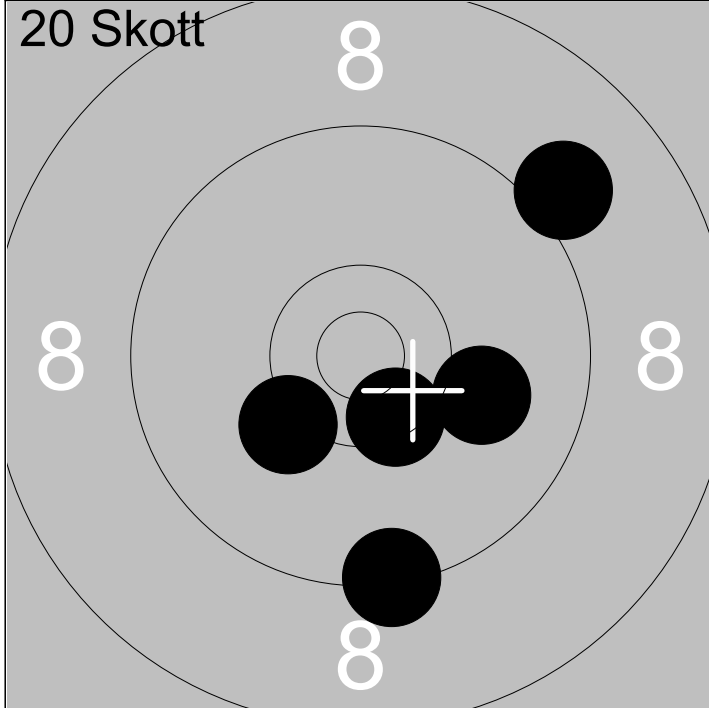

11:	9.1	↗
12:	9.3	↓
13:	10.4x	↙
14:	10.0	→
15:	10.2	↙

Serie	48
Total	143

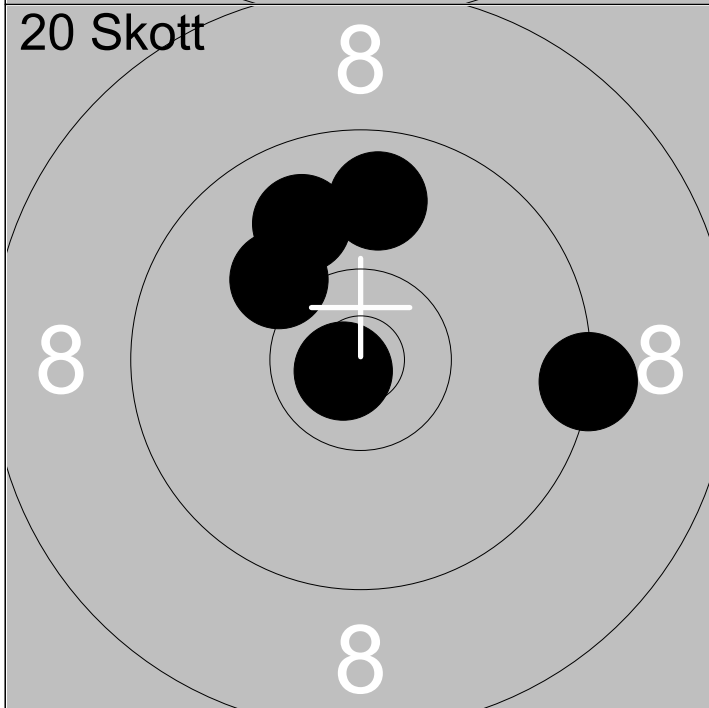

16:	9.3	→
17:	9.9	↗
18:	9.8	↑
19:	10.8x	↙
20:	10.1	↗

Serie	47
Total	190

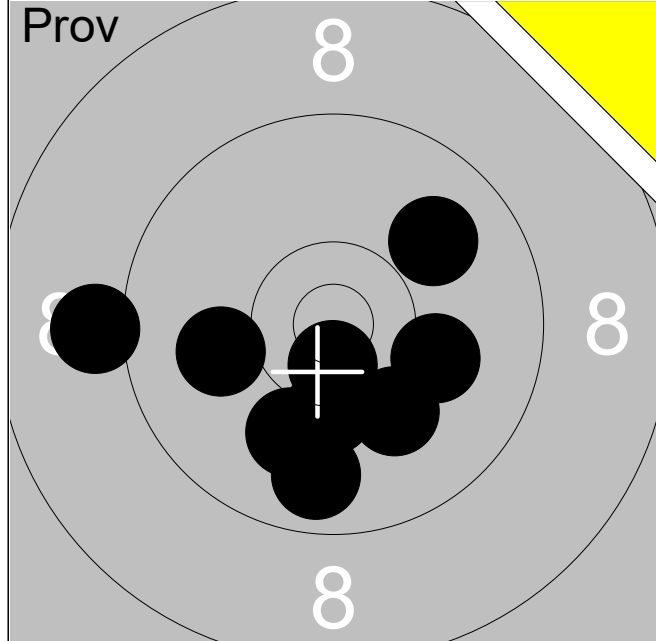

1:	10.0	←
2:	9.8	↓
3:	9.1	←
4:	10.1	→
5:	10.1	↓
6:	10.0	↓
7:	10.3	↓
8:	10.6x	↓
9:	9.9	↗

Serie	87
--------------	-----------

Total	0
--------------	----------

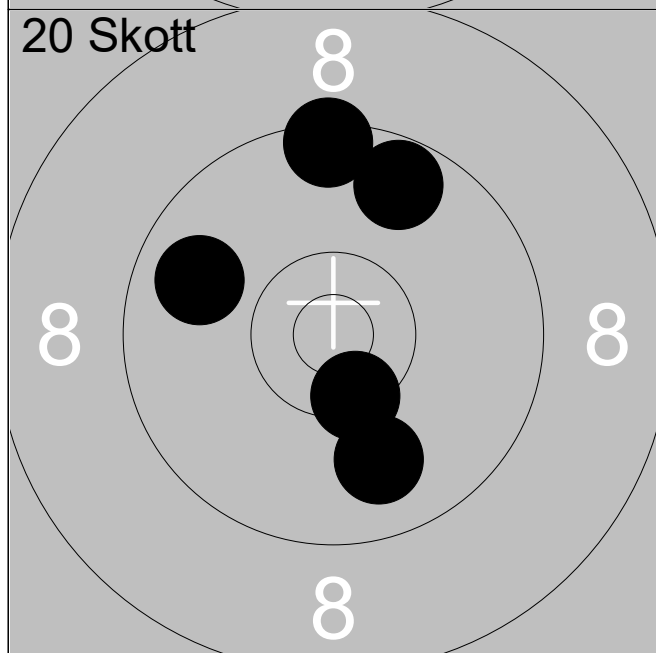

1:	10.4x	↓
2:	9.9	↓
3:	9.7	↗
4:	9.4	↑
5:	9.8	←

Serie	46
--------------	-----------

Total	46
--------------	-----------

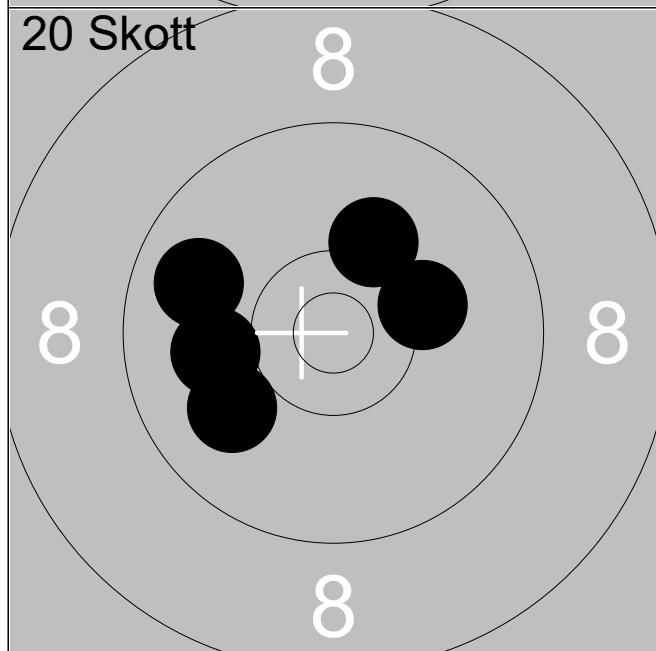

6:	10.0	↙
7:	10.0	←
8:	9.8	↙
9:	10.2	→
10:	10.2	↗

Serie	49
--------------	-----------

Total	95
--------------	-----------

20 Skott

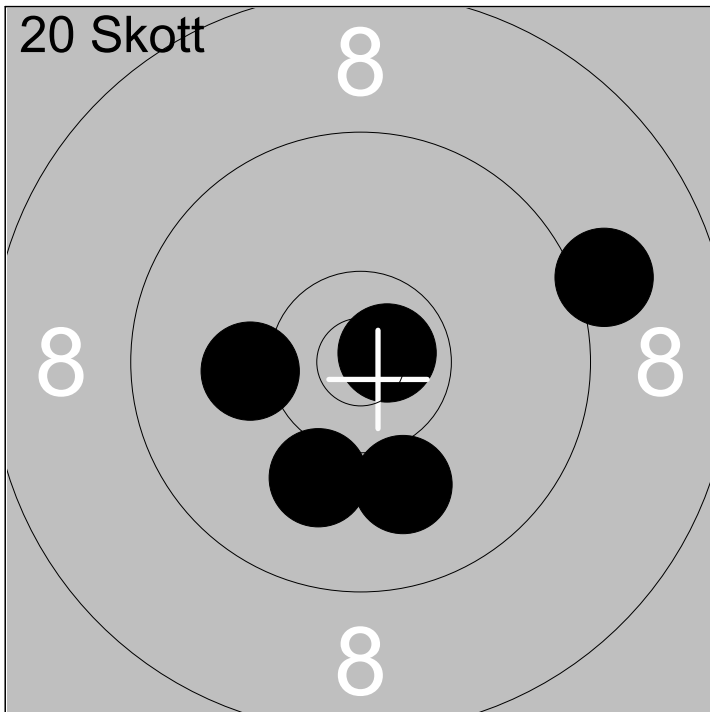

11:	10.2	←
12:	10.0	↓
13:	10.1	↓
14:	9.1	→
15:	10.7x	↗

Serie 49

Total 144

20 Skott

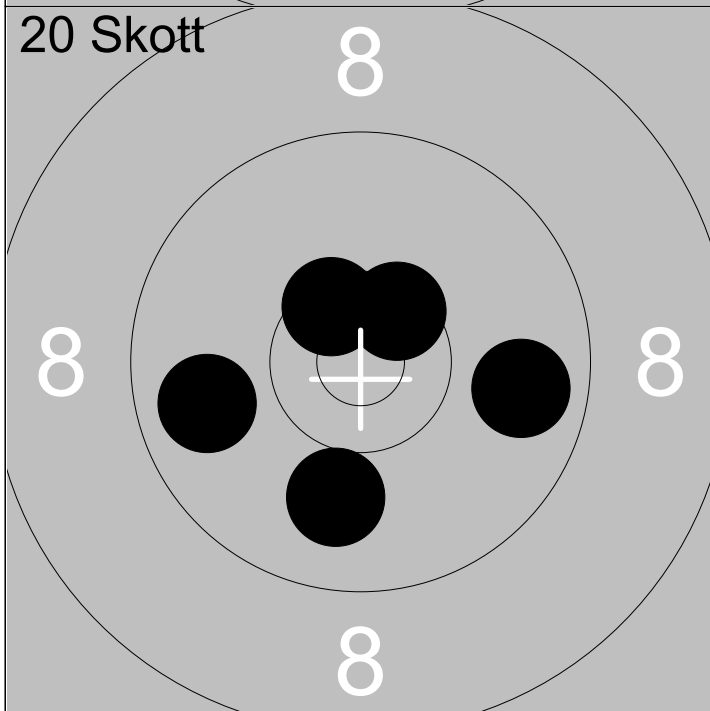

16:	9.8	←
17:	9.8	→
18:	10.0	↓
19:	10.5x	↗
20:	10.5x	↖

Serie 48

Total 192

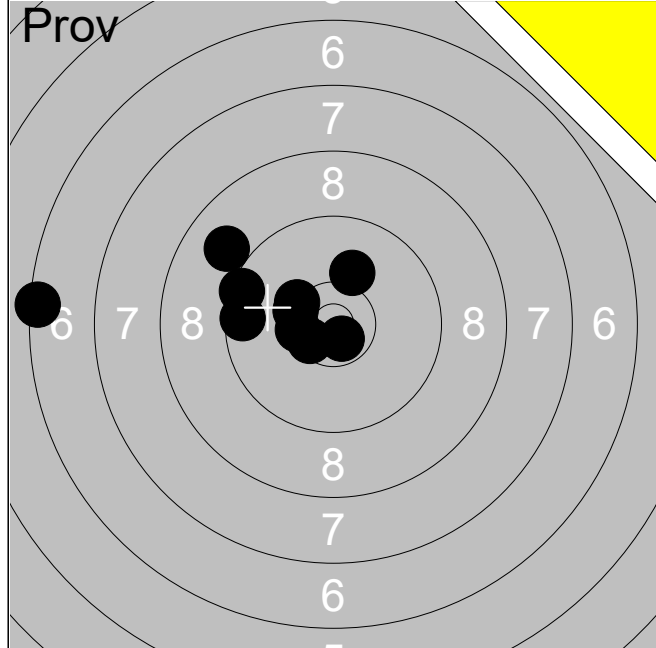

1:	6.4	←
2:	9.5	←
3:	9.0	↗
4:	10.1	↗
5:	10.3x	←
6:	9.6	←
7:	10.7x	↘
8:	10.3x	↗
9:	10.5x	↙
10:	10.4x	←

Serie	93
--------------	-----------

Total	0
--------------	----------

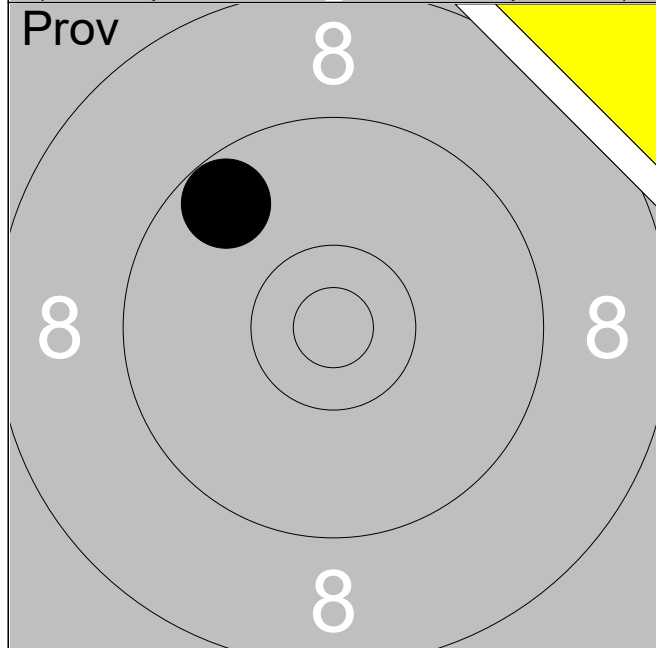

	11:	9.7			↗
--	-----	-----	--	--	---

Serie	9
--------------	----------

Total	0
--------------	----------

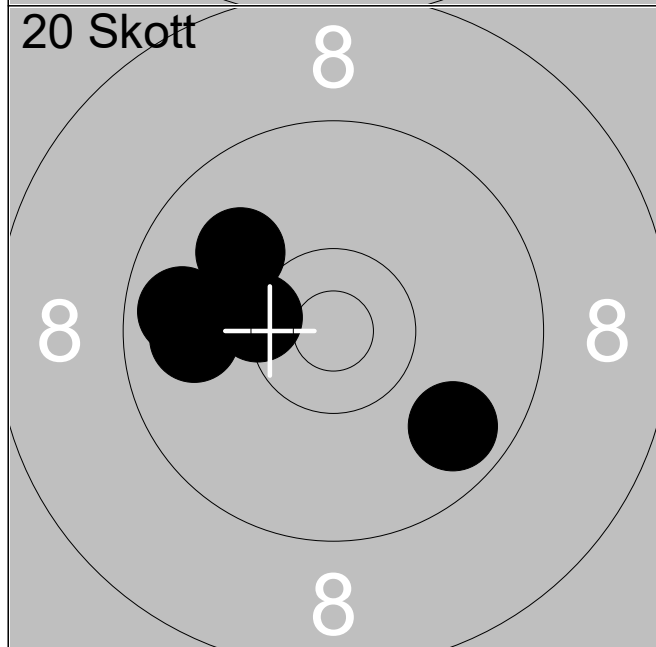

1:	10.0	↗
2:	9.7	↘
3:	9.9	←
4:	9.8	←
5:	10.3x	←

Serie	47
--------------	-----------

Total	47
--------------	-----------

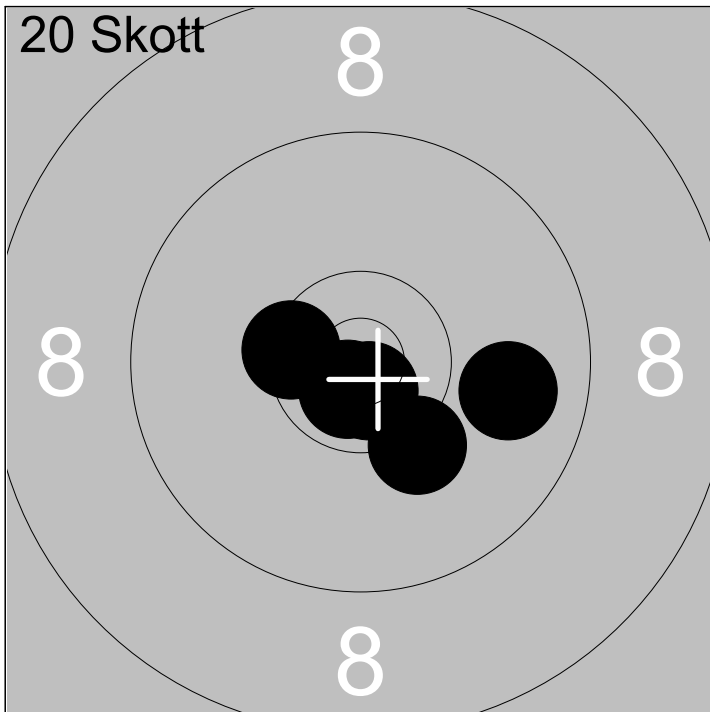

6:	10.7x	↘
7:	10.2	↘
8:	9.9	→
9:	10.7x	↘
10:	10.4x	↖

Serie 49

Total 96

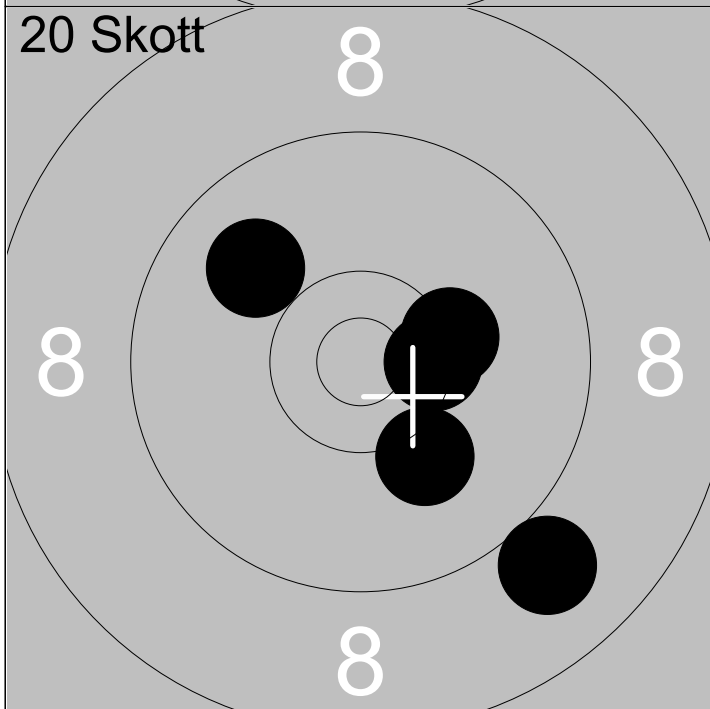

11:	9.0	↘
12:	10.4x	→
13:	10.3	→
14:	10.1	↘
15:	9.9	↗

Serie 48

Total 144

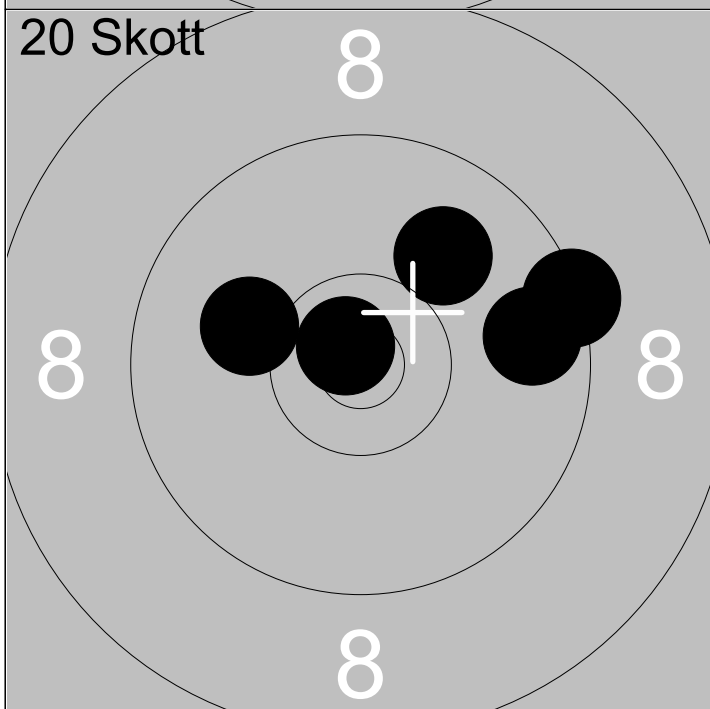

16:	9.7	→
17:	10.8x	↗
18:	10.1	↖
19:	9.4	→
20:	10.0	↗

Serie 48

Total 192

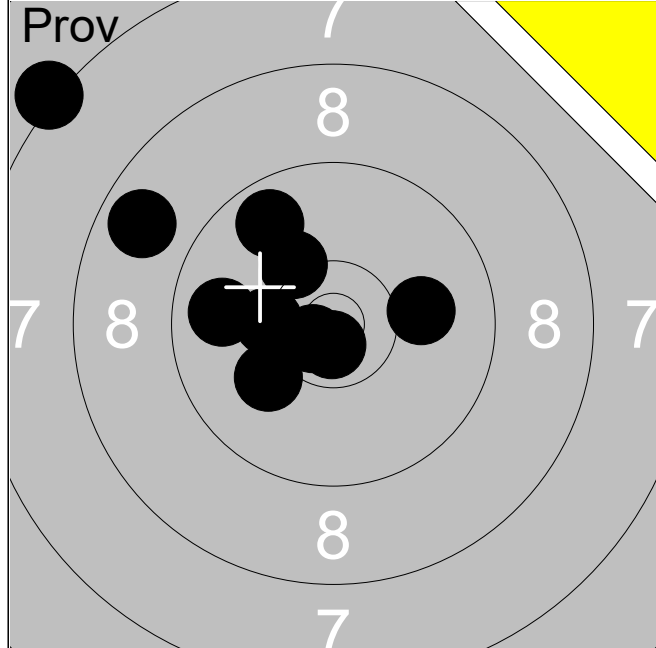

1:	7.2	↗
2:	9.8	←
3:	8.7	↗
4:	10.2	↗
5:	9.7	↗
6:	10.0	→
7:	10.3x	←
8:	10.7x	↓
9:	10.1	↙
10:	10.7x	↙

Serie	93
-------	-----------

Total	0
-------	----------

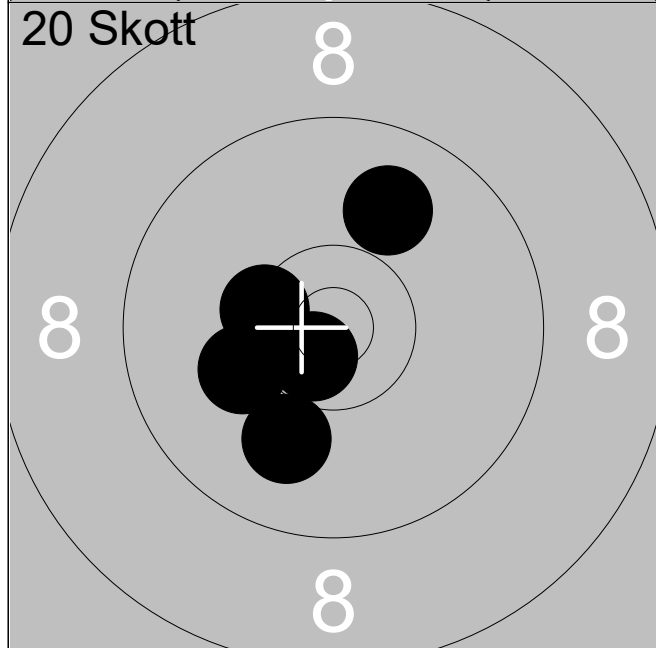

1:	9.9	↗
2:	10.7x	↘
3:	10.4x	←
4:	10.2	←
5:	10.0	↘

Serie	49
-------	-----------

Total	49
-------	-----------

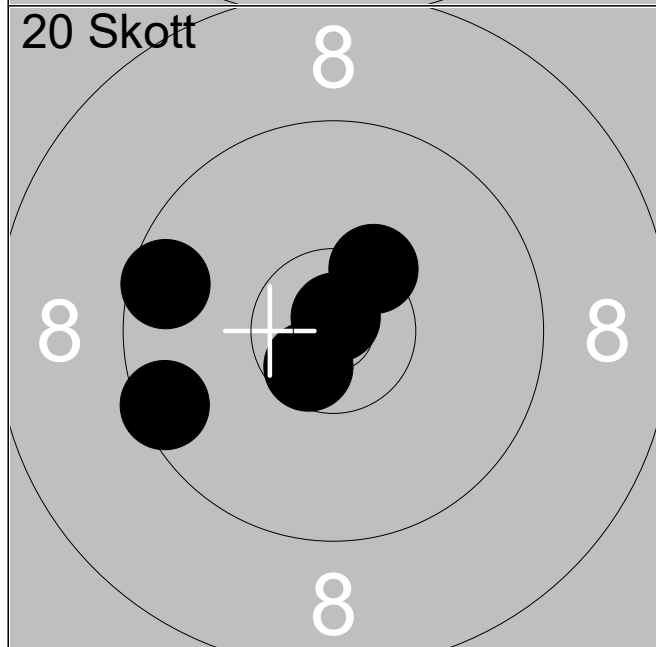

6:	10.8x	↗
7:	10.4x	↗
8:	9.6	←
9:	10.6x	↘
10:	9.5	←

Serie	48
-------	-----------

Total	97
-------	-----------

20 Skott

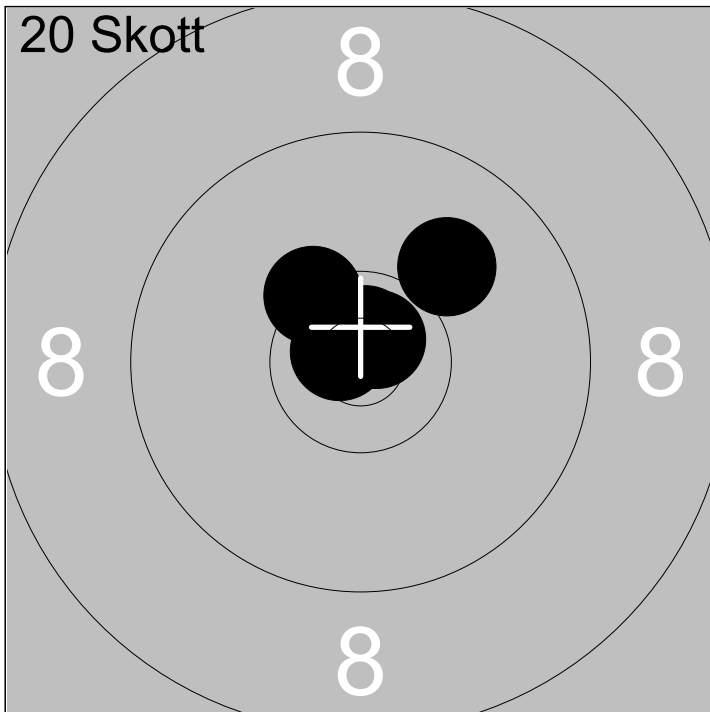

11:	10.8x	↑
12:	10.8x	↗
13:	10.0	↗
14:	10.8x	↖
15:	10.4x	↖

Serie 50

Total 147

20 Skott

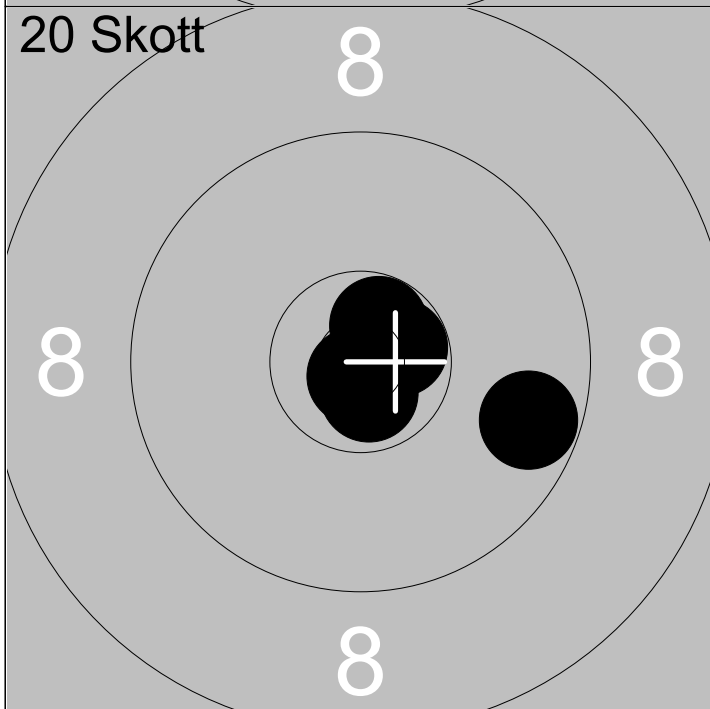

16:	9.7	→
17:	10.8x	↓
18:	10.7x	↓
19:	10.7x	↗
20:	10.7x	→

Serie 49

Total 196

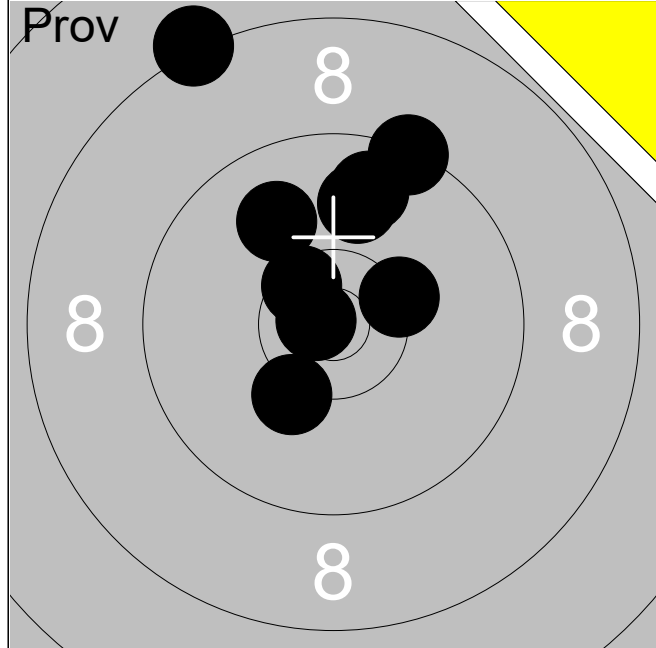

1:	8.3	↖
2:	10.5x	↖
3:	9.9	↑
4:	9.8	↑
5:	10.8x	←
6:	9.9	↖
7:	9.3	↗
8:	10.2	↙
9:	10.3x	↗

Serie	84
--------------	-----------

Total	0
--------------	----------

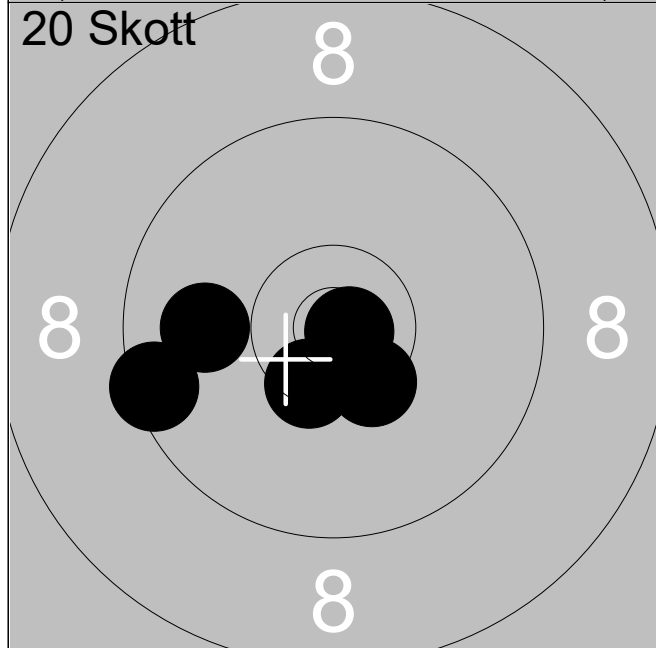

1:	10.5x	↙
2:	10.4x	↙
3:	10.8x	→
4:	9.5	←
5:	9.9	←

Serie	48
--------------	-----------

Total	48
--------------	-----------

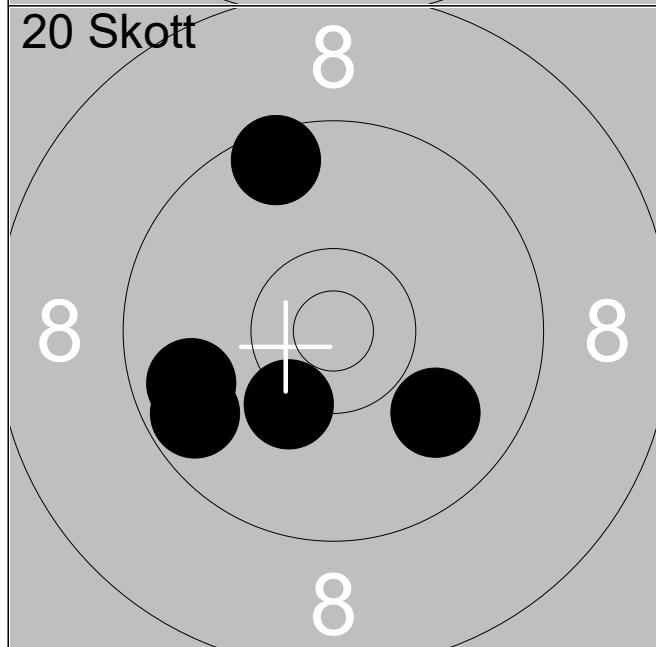

6:	9.9	↙
7:	9.5	↑
8:	9.7	←
9:	10.3	↙
10:	9.8	←

Serie	46
--------------	-----------

Total	94
--------------	-----------

20 Skott

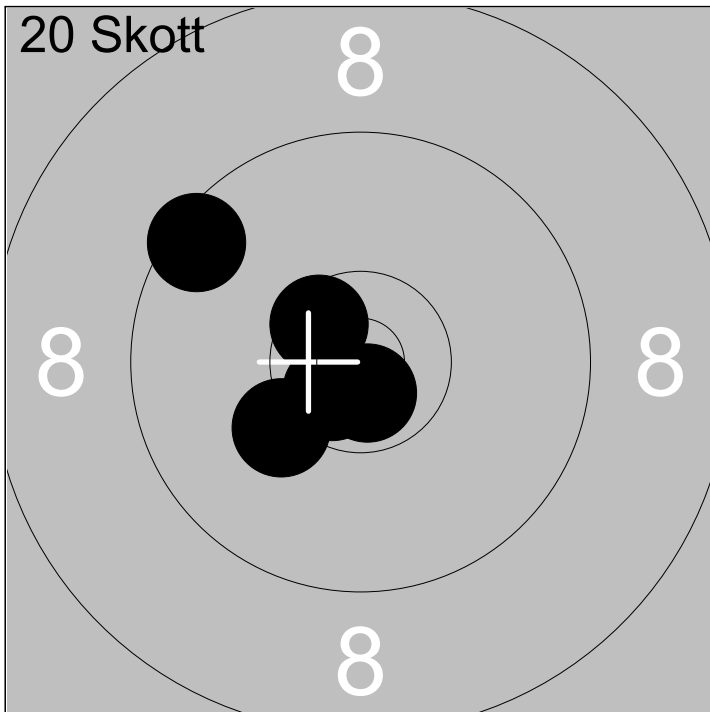

11:	9.5	↖
12:	10.5x	↖
13:	10.7x	↓
14:	10.7x	↙
15:	10.2	↙

Serie 49

Total 143

20 Skott

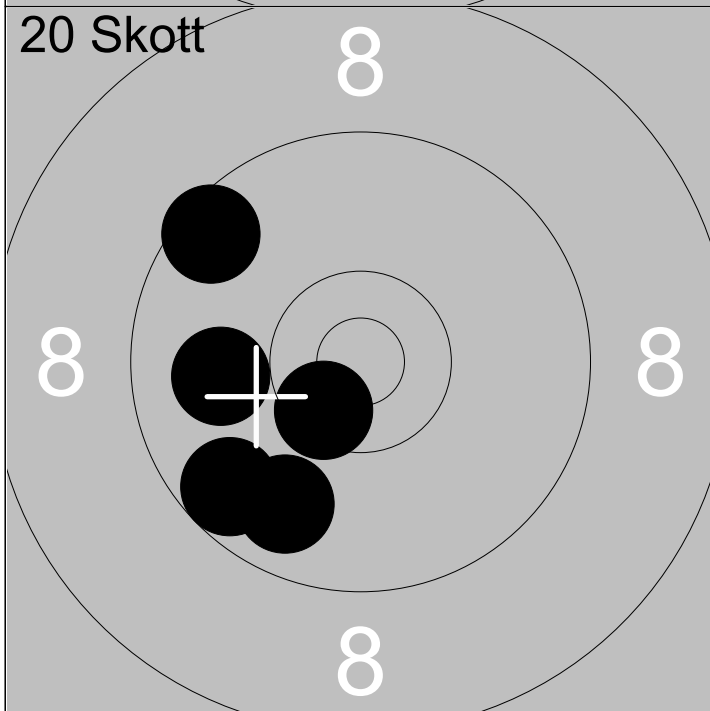

16:	9.9	←
17:	9.8	↘
18:	9.5	↖
19:	10.5x	↘
20:	9.7	↙

Serie 46

Total 189

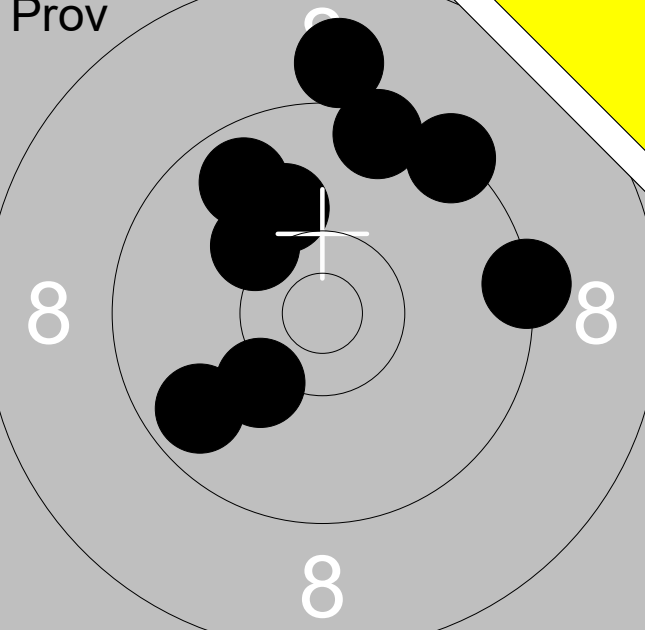
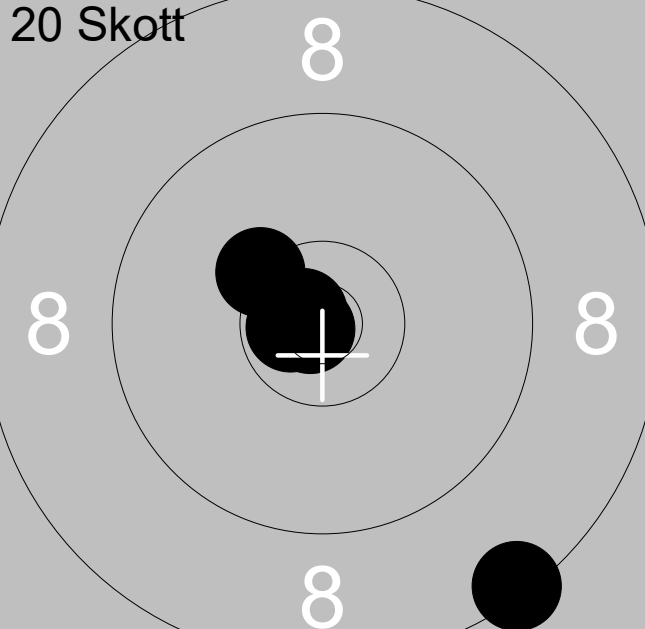
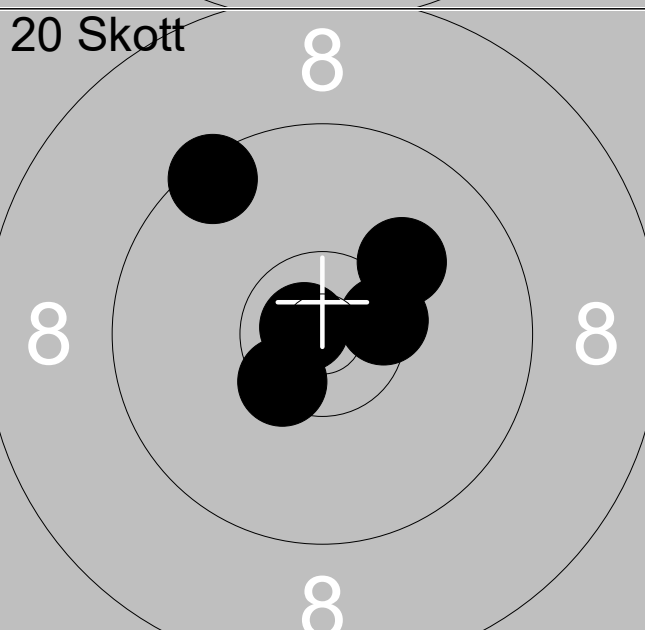
27.07.2018	SM 2018 Ligg Nationellt	Kristinehamn skf	
Prov 	1:	9.0	↑
	2:	9.8	↗
	3:	10.2	↗
	4:	10.1	↑
	5:	9.3	→
	6:	9.4	↗
	7:	9.5	↑
	8:	9.7	↙
	9:	10.2	↙
	Serie		84
Total		0	
20 Skott 	1:	8.4	↘
	2:	10.8x	←
	3:	10.7x	←
	4:	10.3x	↗
	5:	10.8x	↖
Serie		48	
Total		48	
20 Skott 	6:	10.1	↗
	7:	10.8x	←
	8:	10.5x	↘
	9:	10.5x	→
	10:	9.5	↖
Serie		49	
Total		97	

20 Skott

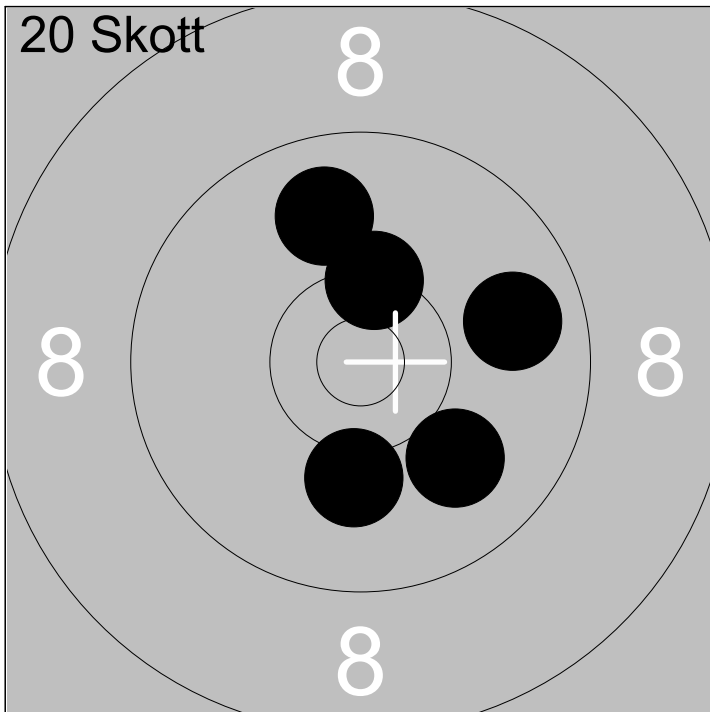

11:	10.4x	↑
12:	10.0	↘
13:	10.1	↓
14:	9.9	↑
15:	9.8	→

Serie 48

Total 145

20 Skott

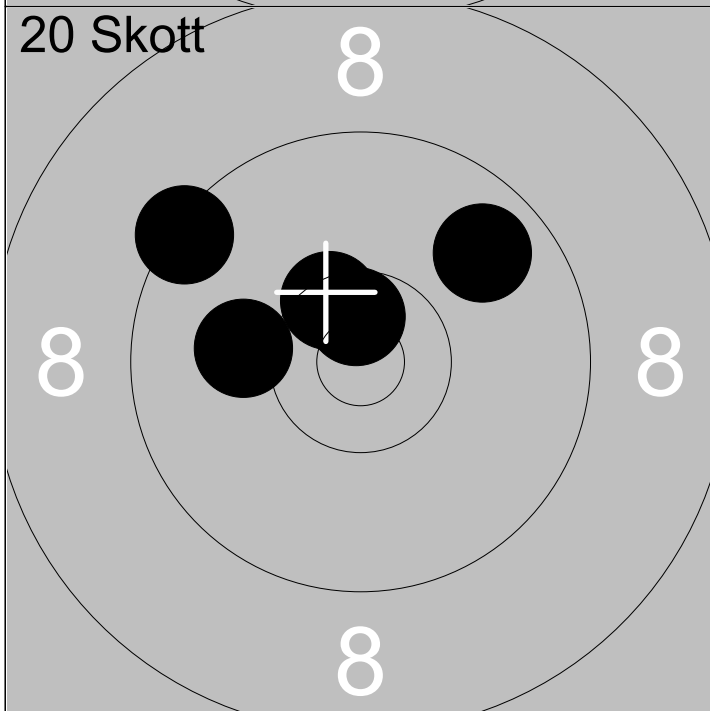

16:	10.6x	↑
17:	9.8	↗
18:	9.4	↖
19:	10.5x	↑
20:	10.1	←

Serie 48

Total 193